

CATÁLOGO

CONVA

EL VALOR DEL CONFORT



1988

Un inicio marcado por la innovación

Conva inicia su actividad en 1988 con una visión disruptiva: convertir barriles de cerveza en mobiliario atractivo y funcional para exteriores. Esta propuesta, tan original como sostenible, definió desde el principio el espíritu de la empresa: creatividad, reutilización y respeto por el entorno.



Evolución

Del cojín al mobiliario profesional

La empresa sigue evolucionando y adapta su producción a las necesidades reales del mercado. Conva pasa a especializarse en mobiliario y parasoles orientados al uso profesional, integrando calidad, durabilidad y personalización. Esta transformación consolida su posición como proveedor fiable para negocios que buscan soluciones pensadas para el día a día de la hostelería.



Años 90

Crecimiento y foco en la hostelería

Durante los años 90, Conva amplía su oferta con la fabricación de cojines específicamente diseñados para uso exterior y para el sector de la hostelería. En 1992 fortalece su compromiso con la reutilización participando en el reaprovechamiento del mobiliario utilizado en las Olimpiadas de Barcelona, un hito que refuerza su papel dentro del sector.



Actualidad

Más de 35 años mirando hacia el futuro

Conva mantiene un compromiso constante con la innovación y la sostenibilidad, incorporando nuevos materiales y procesos más responsables. Tras más de 35 años en el sector, la empresa se ha consolidado como fabricante de referencia en mobiliario exterior para hostelería, uniendo experiencia, diseño y una visión orientada al futuro.

ÍNDICE

GUÍAS RAPIDAS

QUICK GUIDES / GUIDES RAPIDES

MOBILIARIO, COJINES & PUFES

FURNITURE, CUSHIONS & POUFS / MOBILIER, COUSSINS ET POUFS

Muebles pino autoclave	8
Balinesa y tumbonas pino autoclave	10
Muebles teca	12
Muebles aluminio	14
Cojines outdoor & indoor	18
Cojines tumbona	20
Pufs	22

PARASOLES & BASES

SUNSHADES AND BASES / PARE-SOLEIL ET PIEDS

Playa Ø1,8 m	26	Lateral 3x3 m	44
Aqua & Aquatex Ø2 m	28	Lateral Plus 3x3 m	44
Feria Ø2 m	30	Lateral Doble 3x6 m	46
Urban 1,55 1,8x1,3 m	32	Giant 4x4 5x5 m	48
Arena Ø2,5 2x2 m	34	Madera Ø2 2x2 Ø3 3x3 m	50
Via 2x2 m	36		
Patio 2,5x2,5 m	38		
Zoco 2x3 m	38		
Ruedo Ø3 m	38		
Plaza 3x3 m	38		
Heavy Duty Ø3 2x3 3x3 3,5x3,5 m	40		
Master 3x3 3x4 4x4 m	42		
Master descentrado 2,5x3,5 m	42		

COMPLEMENTOS & SEPARADORES

ACCESSORIES & SPACES DIVIDER / COMPLÉMENTS & SÉPARATEURS

Cerramientos	54
Canal vierteaguas	56
Estampación	58
Calefactores	60
Iluminación led	62
Separador espacios	64
Fundas protectoras	66

GUIA RÁPIDA & DATOS TÉCNICOS

QUICK GUIDE & TECHNICAL DATA / GUIDE RAPIDE & CARACTÉRISTIQUES TECHNIQUES

CARTA DE TEJIDOS

FABRIC SWATCH / NUANCIER TISSUS

MOBILIARIO, COJINES & PUFS



*FURNITURE, CUSHIONS AND POUFS
MOBILIER, COUSSINS ET POUFS*



PINO AUTOCLAVE

COLECCIÓN MUEBLES / COLLECTION MOBILIER

Sillón individual / *Fauteuil* | REF. CHPR1
 Sofá 2 plazas / *Canapé* | REF. CHPR2
 Rinconera / *Canapé d'angle* | REF. CHPR1R
 Mesas / *Tableau* | REF. CHPR49 & CHPR4990
 Camino playa / *Chemin de plage* | REF. CHPR90





PINO AUTOCLAVE

TUMBONAS & CAMA BALINESA

Tumbona individual / Bds | REF. CHPR200
 Tumbona doble / Bds Double | REF. CMRPR135
 Cama balinesa reclinable / Lit baldequin | REF. CPR150





TECA

TUMBONAS & ACCESORIOS

Tumbona individual / *Bds* | REF TK-T60
 Tumbona doble / *Bds Double* | REF. TK-C134
 Mesa/banqueta / *Banquet* | REF. TK-M45
 Respaldo / *Têteière de plage* | REF. TK-R70





ALUMINIO

COLECCIÓN MUEBLES

Sofá / Canapé:
 - con brazos | REF. CHAV2B
 - sin brazos | REF. CHAV2SB
 Sillón / Fauteuil:
 - con brazos | REF. CHAV1
 - sin brazos | REF. CHAV1SB
 Rinconera / Canapé d'angle | REF. CHAV1R
 Mesa rectangular / Tableau | REF. CHAV90





ALUMINIO

TUMBONAS & CAMA BALINESA

Tumbona doble | REF. CMRAL150VL
Cama balinesa reclinable | REF. CBRAL-X180VL





COJINES OUTDOOR & INDOOR

CUADRADOS, RECTANGULARES & RULO | MEDIDAS ESPECIALES

Cuadrantes decorativos | Cuadrados, rectangulares & rulo
Cojines especiales | Fabricados en gran variedad de tejidos y medidas especiales,



ACRÍLICO

COJINES TUMBONA



NAUTÍCO

COJINES TUMBONA



TEXTILENE/BATYLINE

COJINES TUMBONA

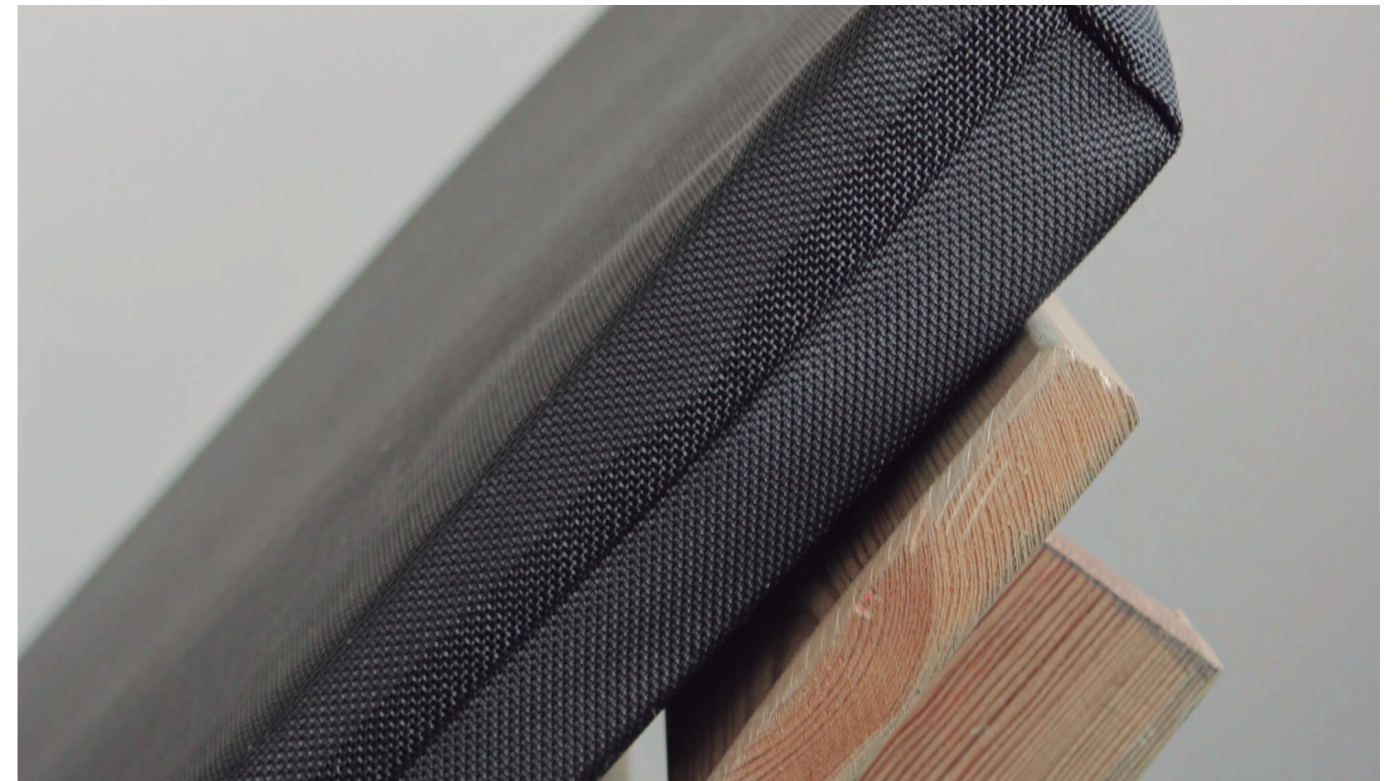

PUFS

REF. PF111/PF112 | 135x105 cm & 135x 105
REF. PF113/PF114 | 110x80x70 cm & 80x70x65 cm



PARASOLES & BASES

LÍNEA FORTE & LÍNEA BASIC



SUNSHADES AND BASES
PARE-SOLEIL ET PIEDS



PLAYA

LÍNEA FORTE

Acero inoxidable / Acier inoxydable | Ø1,8 m | REF. 819



AQUA & AQUATEX

LÍNEA FORTE

Aluminio estriado / Aluminium strié | Ø2 | REF.839 & 833



FERIA

LÍNEA BASIC

Aluminio inclinable / Aluminium inclinable | Ø2 m | REF. 821



URBAN

LÍNEA FORTE



Acero galvanizado / Acier galvanisé | 1,55x1,55 m & 1,8x1,3 m | REF. 815



ARENA

LÍNEA BASIC

Aluminio / Aluminium | Ø2,5 m & 2x2 m | REF. 892 & 888



VIA
LÍNEA FORTE

Aluminio / Aluminium | 2x2 m | REF.875.2



PATIO, ZOCO, RUEDO & PLAZA

LÍNEA BASIC

Aluminio / Aluminium | 2,5x2,5, 2x3, 3x3 & Ø3 m | REF. 897, 885, 898 & 886



HEAVY DUTY

LÍNEA FORTE

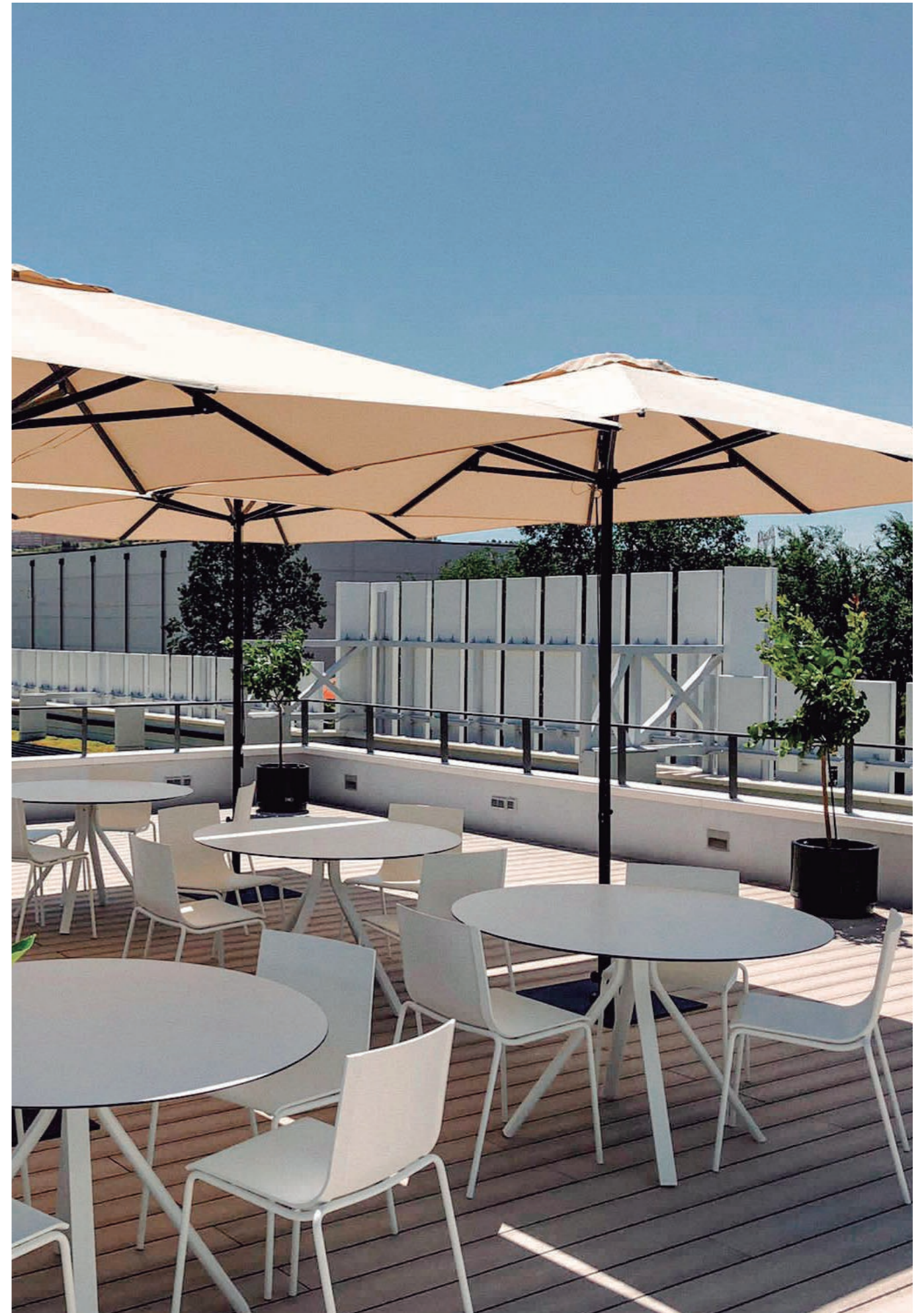

Aluminio reforzado / Aluminium reforçé | Ø3, 2x3, 3x3 & 3,5x3,5 m | REF. 876, 887, 899 & 895

MASTER

LÍNEA FORTE



Aluminio / Aluminium | 3x3, 3x4 & 4x4 m | REF. 889,884 & 894

MASTER DESCENTRADO

LÍNEA FORTE



Aluminio / Aluminium | 2,5x3,5 m | REF. 890



LATERAL

LÍNEA BASIC



Aluminio / Aluminium | 3x3 m | REF. 878

LATERAL PLUS

LÍNEA FORTE



Aluminio / Aluminium | 3x3 m | REF. 879

LATERAL DOBLE

LÍNEA FORTE



Aluminio antracita | 6x3 m | REF. 881

GIANT

LÍNEA FORTE



Aluminio / Aluminium | 4x4 & 5x5 m | REF. 864 & 865



MADERA

LÍNEA FORTE



Madera Haya / Bois de hêtre | Ø2, Ø3, 2x2 & 3x3 m | REF. 841, 843, 842 & 844

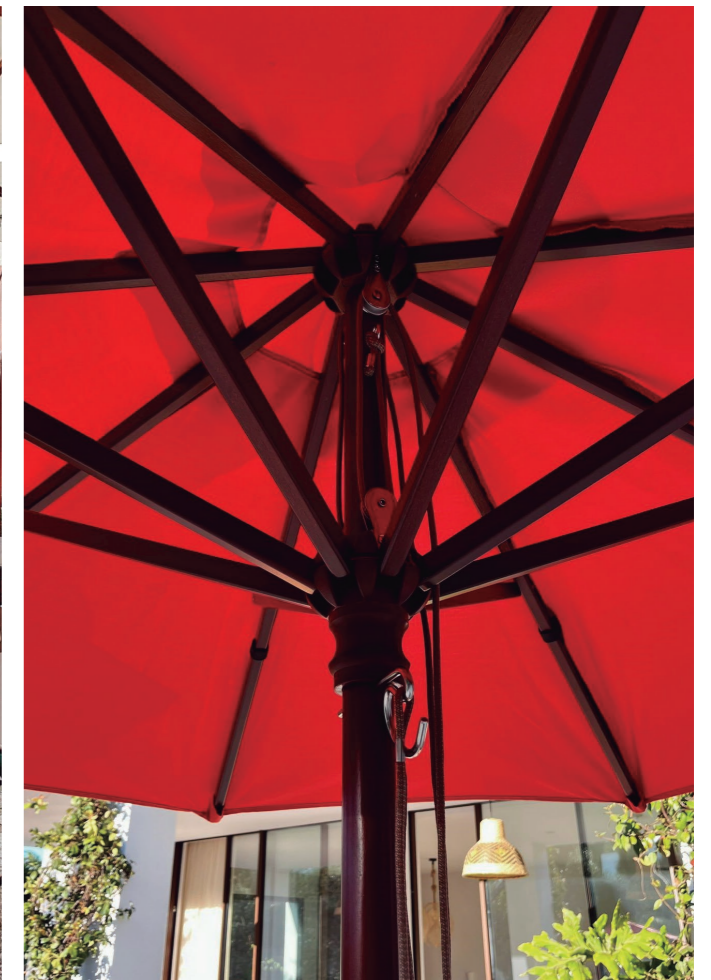

COMPLEMENTOS & SEPARADORES



ACCESSORIES & SPACES DIVIDER
COMPLÉMENTS & SÉPARATEURS

CERRAMIENTOS

CON CORTINAS PARA PARASOLES



CANAL VIERTEAGUAS

PARA PARASOLES



ESTAMPACIÓN PUBLICIDAD

PRINTING ADVERTISING / IMPRESSION PUBLICITAIRE



CALEFACTORES

PARA PARASOLES



Lámpara halógena mini | REF. EST20LG
Lámpara carbono | REF. EST20CA
Lámpara halógena | REF. EST20HA



ILUMINACIÓN LED

PARA PARASOLES

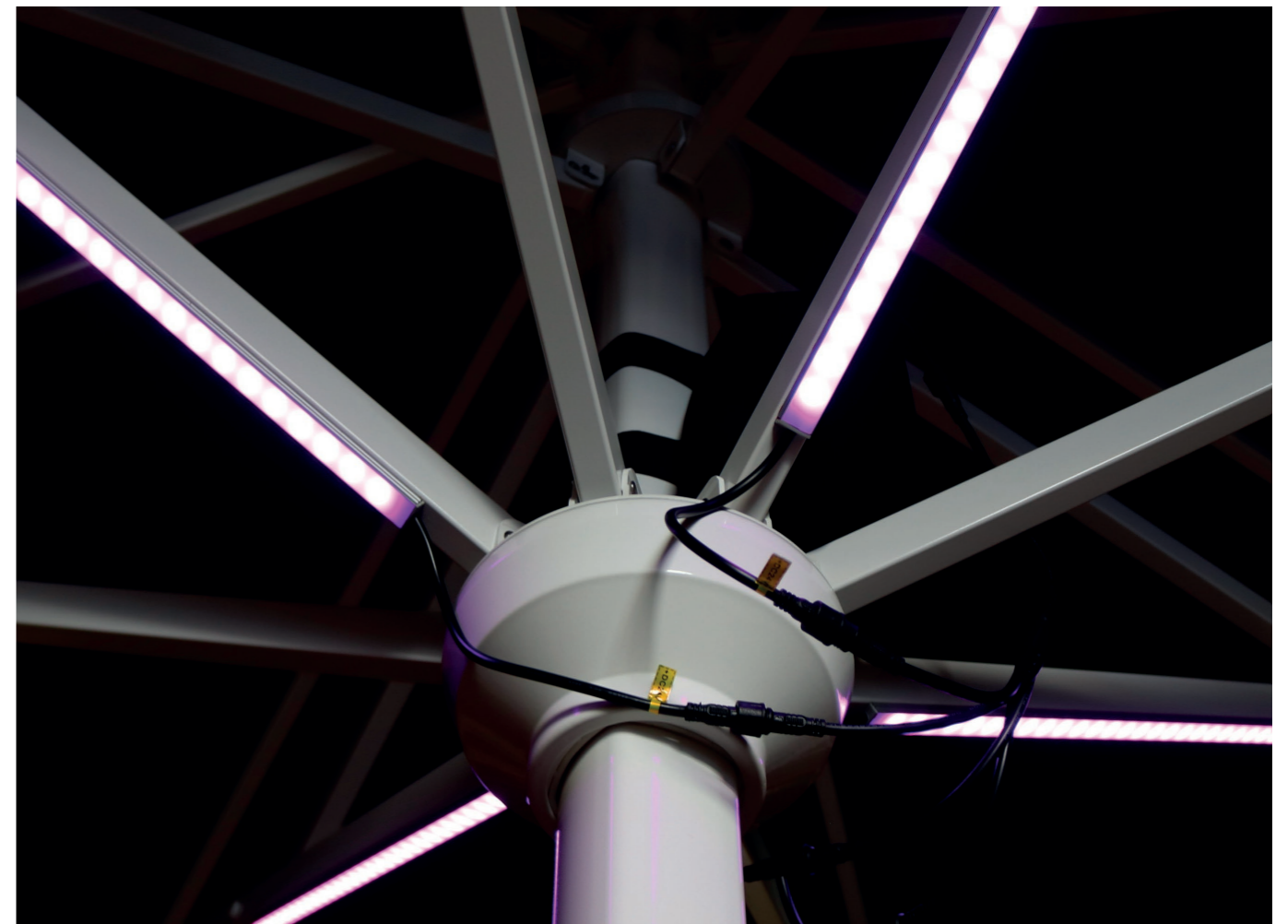

SEPARADOR ESPACIOS

SPACE DIVIDERS / SÉPARATEURS D'ESPACES



Separador terraza / Séparateur terrasse | REF. SPTZ150MS
Separador transparente / Séparateur transparent | REF. SPR150PVC
Separador playa / Séparateur de plage | REF. BS180
Separador jardinera / Séparateur jardinière | REF. SEPM100HCRE

FUNDAS PROTECTORAS

PROTECTIVE COVERS / HOUSES DE PROTECTION

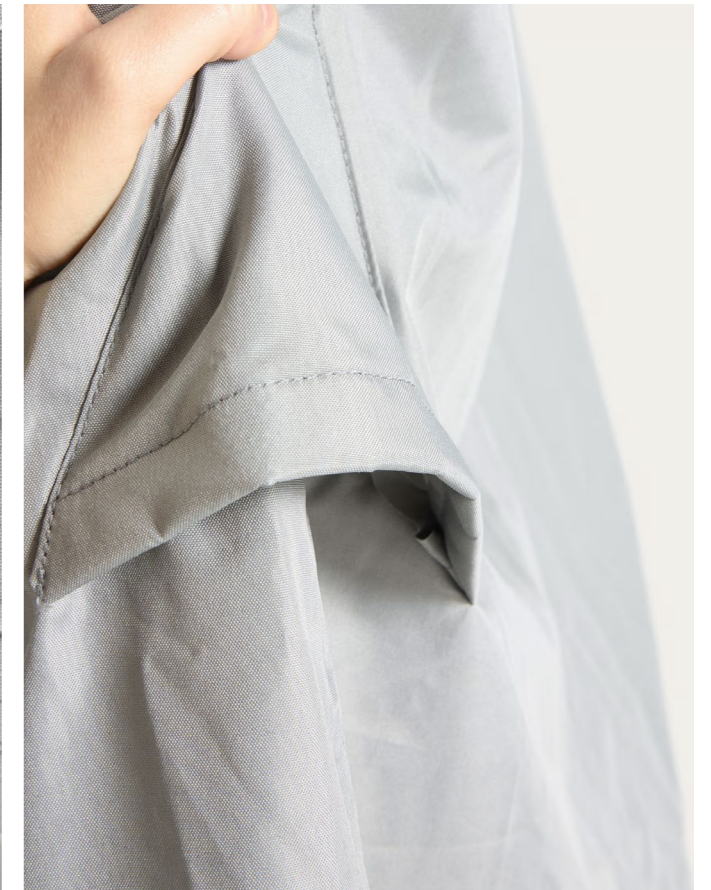

Fundas multitex y ripstop



COMPLEMENTOS PARASOL

DATOS TCNICOS

MOBILIARIO PINO AUTOCLAVE

MOBILIER EN BOIS DE PIN

SILLÓN INDIVIDUAL | REF. CHPR1



14,5 kg
Acrylic Basic & Masa Soft
Nautic Class, Bio Plus & Melange

CHAIR / CAHUFFEUSE

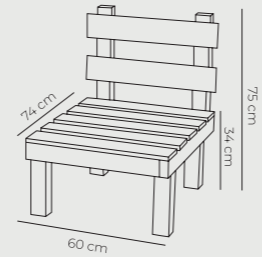

SOFÁ DOS PLAZAS | REF. CHPR2



24 kg
Acrylic Basic & Masa Soft
Nautic Class, Bio Plus & Melange

SOFA / CANAPÉ DEUX PLACES

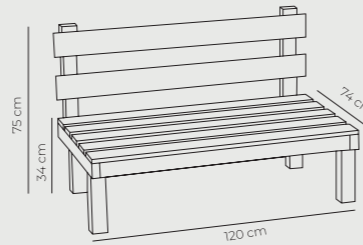

RINCONERA | REF. CHPR1R



18,5 kg
Acrylic Basic & Masa Soft
Nautic Class, Bio Plus & Melange

CORNER ARMCHAIR / CHAUFFEUSE D'ANGLE

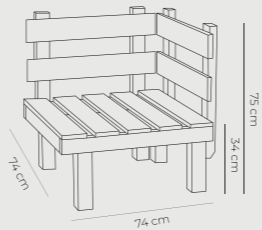

MESA | REF. CHPR49



9,5 kg
Acrylic Basic & Masa Soft
Nautic Class, Bio Plus & Melange
OPCIONAL: Cojín / Cushion / Coussin

SMALL COFFE TABLE / BANQUET

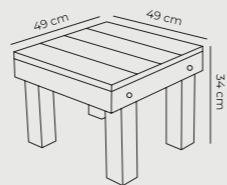

MESA RECTANGULAR | REF. CHPR4990



12,8 kg
Acrylic Basic & Masa Soft
Nautic Class, Bio Plus & Melange
OPCIONAL: Cojín / Cushion / Coussin

LONG COFFE TABLE / TABLEAU

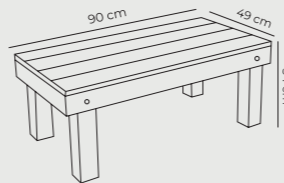

TUMBONA INDIVIDUAL | REF. CHPR200

LOUNGER / BDS



Acrylic Basic & Masa Soft
Nautic Class, Bio Plus & Melange

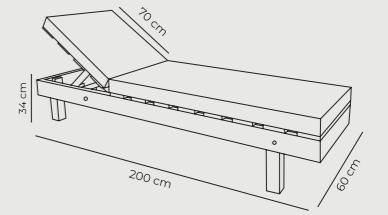

TUMBONA DOBLE | REF. CMRPRI35

DOUBLE LOUNGER / BDS DOUBLE



94 kg
Nautic Class, Bio Plus & Melange

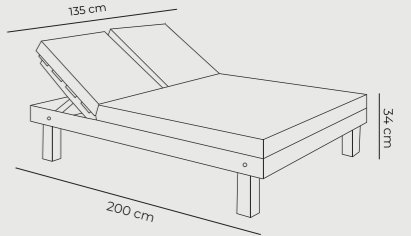

CAMA BALINESA RECLINABLE | REF. CPR150

DAYBED / LIT BALDAQUIN



115 kg
Nautic Class, Bio Plus & Melange

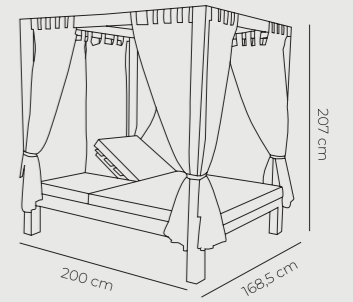

COLCHÓN: 150x200x10 cm
INCLUYE / INCLUDES / INCLUS:
8 cortinas en acrílico con velcro / 8 acrylic curtains with velcro /
8 rideaux en acrylique avec velcro

CAMINO DE PLAYA | REF. CHPR90

BEACH WALKWAY / CHEMIN DE PLAGÉ



13,5 kg

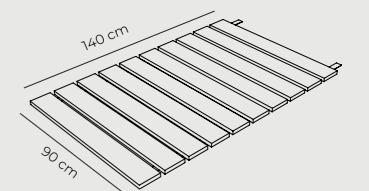

MOBILIARIO MADERA TECA

MOBILIER EN BOIS DE TECK

TUMBONA INDIVIDUAL | REF. TK-T60

LOUNGER / BDS



25,04 kg
Acrylic Basic & Masa Soft
Nautic Class, Bio Plus & Melange

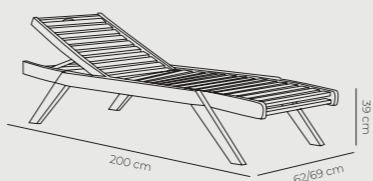

TUMBONA DOBLE | REF. TK-C134

DOUBLE LOUNGER / BDS DOBLE



37,85 kg
Acrylic Basic & Masa Soft
Nautic Class, Bio Plus & Melange

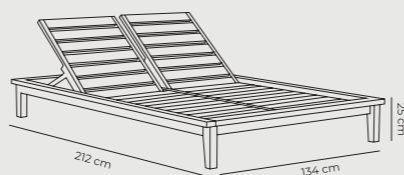

MESA/BANQUETA | REF. TK-M45

SMALL COFFE TABLE / BANQUET



5,35 kg
Acrylic Basic & Masa Soft
Nautic Class, Bio Plus & Melange
OPCIONAL: Cojín / Cushion / Coussin

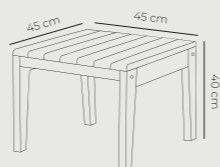

RESPALDO | REF. TK-R70

RECLINING BACKREST / TÊTIÈRE DE PLAGE

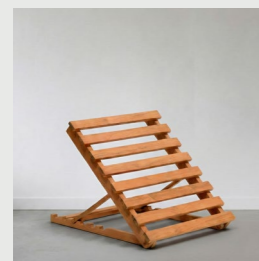

5,82 kg
Acrylic Basic & Masa Soft
Nautic Class, Bio Plus & Melange
OPCIONAL: Cojín / Cushion / Coussin

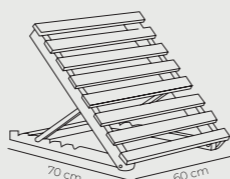

MOBILIARIO ALUMINIO

MOBILIER EN ALUMINIUM

SOFÁ CON BRAZOS | REF. CHAV2B

SOFA / CAHUFFEUSE



42,8 kg
OPCIÓN: REF. CHAV2SB (Sin brazos) (36,6 kg)
Acrylic Basic & Masa Soft
Nautic Class, Bio Plus & Melange

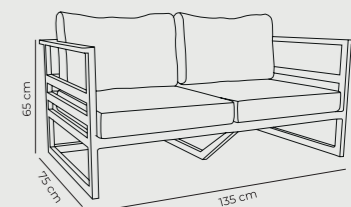

SILLÓN CON BRAZOS | REF. CHAV1

ARMCHAIR / CAHUFFEUSE



24,8 kg
OPCIÓN: REF. CHAV1SB (Sin brazos) (23 kg)
Acrylic Basic & Masa Soft
Nautic Class, Bio Plus & Melange

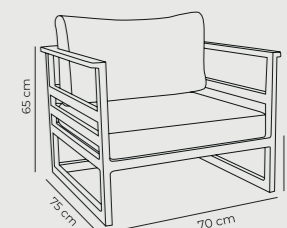

RINCONERA | REF. CHAV1R

CORNER ARMCHAIR / CHAUFFEUSE D'ANGLE



24,4 kg
Acrylic Basic & Masa Soft
Nautic Class, Bio Plus & Melange

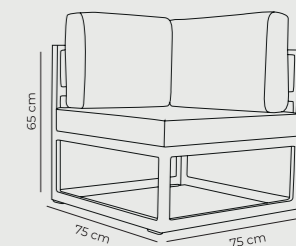

CAMASTRO RECLINABLE | REF. CMRAL150VL

DOUBLE LOUNGER / BDS



54,10 kg
Nautic Class, Bio Plus

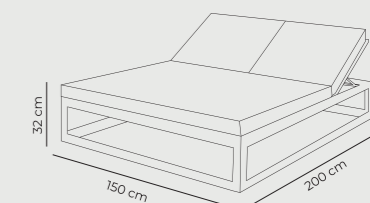

CAMA BALINESA RECLINABLE | REF. CBRAL-X180VL

RECLINING DAYBED / LIT BALDAQUIN INCLINABLE



79 kg
Nautic Class, Bio Plus



INCLUYE / INCLUDES / INCLUS:
Cortina-techo corredera / Sliding curtain-roof / Rideau-toit coulissant

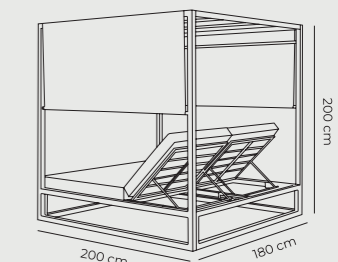

MESA RECTANGULAR | REF. CHAV90

LONG COFFE TABLE / TABLEAU

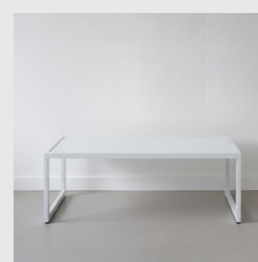

5,5 kg

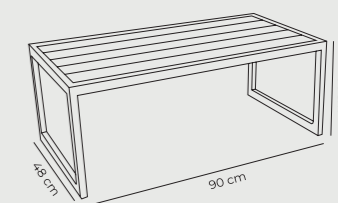

COJINES & PUFES

COUSSINS ET POUFS

PUFF | REF. PF113/PF114



Bolitas de poliestireno expandido de alta densidad. / High-density expanded polystyrene beadsexpansé (EPS) / Perles de polystyrène expansé haute densité

110x80x70 cm / 80x70x65 cm

Acrylic Basic & Masa Soft
Nautic Class, Bio Plus & Melange

PUFF | REF. PF111/ PF112



Bolitas de poliestireno expandido de alta densidad. / High-density expanded polystyrene beadsexpansé (EPS) / Perles de polystyrène expansé haute densité

135x105 cm / 135x175 cm

Acrylic Basic & Masa Soft
Nautic Class, Bio Plus & Melange

DECORATIVOS

Funda interior y fibra / Inner sheath and fiber / Gaine intérieure et fibre

Acrylic Basic & Masa Soft
Nautic Class, Bio Plus & Melange

RECTANGULAR/RIÑONERA



30x50 cm / 60x40 cm / 60x75 cm

CUADRADO



40x40 cm / 45x45 cm / 50x50 cm /
55x55 cm / 60x60 cm

RULO

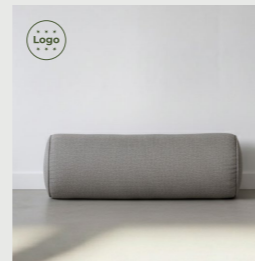

Ø20x60 cm

TUMBONA



ACRÍLICO

Espuma de poliuretano alta densidad / High density polyurethane foam / Mousse de polyuréthane haute densité

VINILOS NÁUTICOS

Espuma de poliuretano alta densidad / High density polyurethane foam / Mousse de polyuréthane haute densité

TEXTILENE/BATYLINE

Fibra compacta permeable y no absorbente / Permeable and non-absorbent compact fiber / Fibre compacte perméable et non absorbate

ESTAMPACIÓN
COJINES & PARASOLES

IMPRESSION COUSSINS ET PARASOLS

SERIGRAFIA



Colores intensos y alta durabilidad / Strong colours and long-lasting finish / Couleurs intenses et grande durabilité.

Ideal para logotipos simples o diseños con pocos colores / Ideal for simple logos or few-colour designs / Idéal pour logos simples ou designs à peu de couleurs

Resistente a exterior y lavados / Resistant to outdoor use and washing / Résistant à l'extérieur et aux lavages

Acabado integrado en el tejido / Ink becomes integrated into the fabric / Encre intégrée au tissu

VINOLO



Permite gran detalle y precisión / High detail and precision / Très bon niveau de détail et précision

Apto para diseños complejos o con degradados / Perfect for complex or gradient designs / Convient aux designs complexes ou avec dégradés.

Buena resistencia al exterior / Good outdoor resistance / Bonne résistance extérieure

Acabado ligeramente en relieve sobre el tejido / Slightly raised finish on the fabric / Finition légèrement en relief sur le tissu



MODELOS DE PARASOL

MODÈLES DE PARASOLS

PÁG. 26-50

PLAYA | Ø1,8 m

REF. 819

FORTE

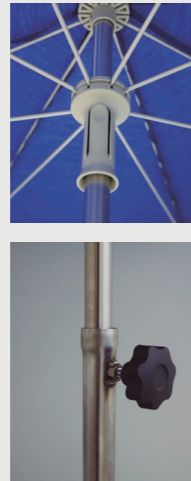

- Inox [2 pcs]
- Acero inoxidable (Ø23 mm) Pared (1,5 mm) / Stainless steel (Ø23 mm) Wall (1,5 mm) / Acier inox (Ø23 mm) Épaisseur (1,5 mm)
- 8 uds zincadas (Ø4,6 mm) / 8 pcs galvanized (Ø4,6 mm) / 8 pièces galvanisées (Ø4,6 mm)
- HS20 - MV39 - HS40
- Olefin 190, Acrylic Basic & Acrylic Masa Soft

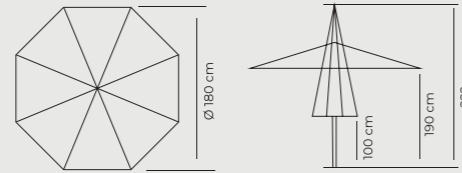

819TP

Pincho de acero inox 99 cm / Sujeción con tornillo de presión / Diámetro int: Ø25 mm
Stainless steel lower pole 99 cm / Pressure screw for pole fixation / Inner diameter: Ø25 mm
Mât inférieur en acier inoxydable 99 cm / Fixation avec un vis papillon / Diamètre intérieur: Ø25 mm

819PIN

Pincho de acero zincado 120 cm / Perfil de 3x3 cm / Doble guía para el mástil / Peso: 2,5 kg
Angle steel picket 120 cm / Profil 3x3 cm / Double guide for pole adjust / Weight: 2,5 kg
Cornière en acier zingué 120 cm / Profilé 3x3 cm / Guidage avec double bague / Poids: 2,5 kg

AQUA & AQUATEX | Ø2 m

REF. 833/839

FORTE



- Blanco / White / Blanc [2 pcs]
- Aluminio estriado (Ø35-40 mm) Pared (1,25 mm) / Fluted aluminium (Ø35-40 mm) Wall (1,25 mm) / Aluminium strie (Ø35-40 mm) Épaisseur (1,25 mm)
- 10 uds fibra de vidrio (Ø6,35 mm) / 10 pcs fibreglass (Ø6,35 mm) / 10 pièces de fibre de verre (Ø6,35 mm)
- HS20 - MP20 - TH22 - TH30
- Aqua:** Polyester beige, Olefin 190, Acrylic Basic & Acrylic Masa Soft
Aquatex: Textilene

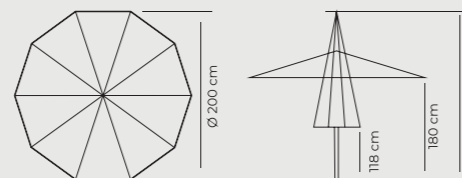

FERIA | Ø2 m

REF. 821

BASIC

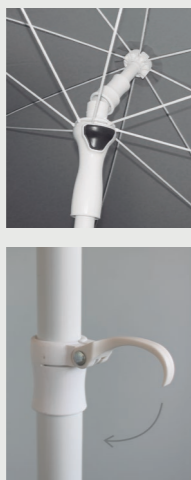

- Blanco / White / Blanc [2 pcs]
- Aluminio (Ø29-32 mm) Pared (1 mm) / Aluminium (Ø29-32 mm) Wall (1 mm) / Aluminium (Ø29-32 mm) Épaisseur (1 mm)
- 8 uds acero (Ø3,8 mm) / 8 uds (Ø3,8 mm) steel / 8 uds en acier (Ø3,8 mm)
- HS15 - HS20 - MP20 - TH22
- Polyester beige, Olefin 190, Acrylic Basic & Acrylic Masa Soft

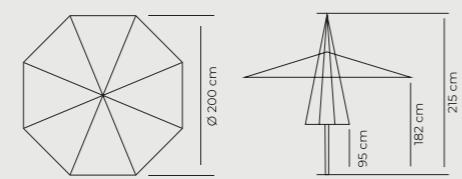

URBAN | 1,55x1,55 m & 1,8x1,3 m

REF. CU815/RE815

FORTE

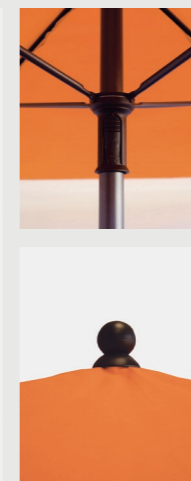

- Antracita / Anthracite / Anthracite [2 pcs]
- Acero galvanizado (Ø33-36 mm) Pared (0,7 mm) / Galvanised steel (Ø33-36 mm) Wall (0,7 mm) / Acier galvanisé (Ø33-36 mm) Épaisseur (0,7 mm)
- 4 uds paragón acero galvanizado (Ø8 mm) / 4 pcs similar to galvanised steel (Ø8 mm) / 4 pièces similaires à l'acier galvanisé (Ø8 mm)
- HS20 - TH22 - TH30 - MP20
- Olefin 190, Acrylic Basic & Acrylic Masa Soft

CU815 URBAN 1,55x1,55 m

RE815 URBAN 1,8x1,3 m

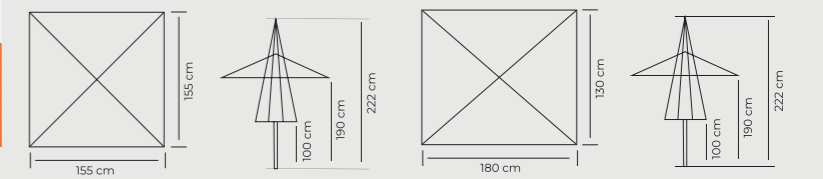

ARENA | Ø2,5 m & 2x2 m

REF. 892/888

BASIC

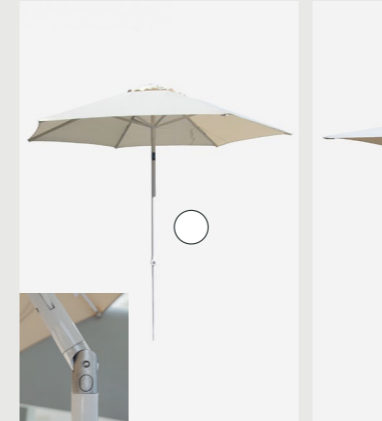

- Blanco / White / Blanc [2 pcs]
- Aluminio (Ø38-35 mm) Pared (1 mm) / Aluminium (Ø38-35 mm) Wall (1 mm) / Aluminium (Ø38-35 mm) Épaisseur (1 mm)
- Arena Ø2,5 m:** 6 uds aluminio (14x20 mm) Pared (9 mm)
Arena 2x2 m: 4 uds aluminio (14x20 mm) Pared (9 mm)
- HS20 - TH22 - TH30 - MP20
- Polyester beige, Olefin 190, Acrylic Basic & Acrylic Masa Soft

892 ARENA Ø2,5 m

888 ARENA 2x2 m

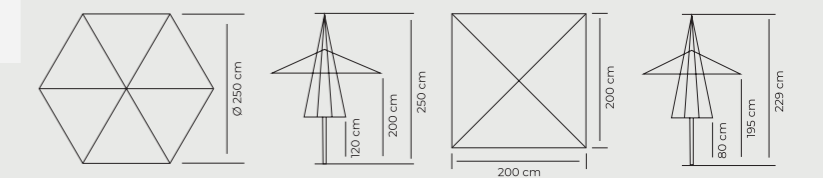

Salida de vientos / Wind exit / Sortie du vent

VIA | 2x2 m

REF. 875.2

FORTE

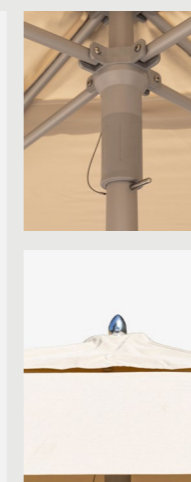

- Gris Plata / Silver Grey / Gris argent [1 pc]
- Aluminio (Ø38 mm) Pared (2 mm) / Aluminium (Ø38 mm) Wall (2 mm) / Aluminium (Ø38 mm) Épaisseur (2 mm)
- 4 uds aluminio (Ø19 mm) Pared (1,6 mm) / 4 pcs aluminium (Ø19 mm) Wall (1,6 mm) / 4 pièces aluminium (Ø19 mm) Épaisseur (1,6 mm)
- HS20 - TH22 - TH30 - MP20
- Polyester beige, Olefin 190, Acrylic Basic & Acrylic Masa Soft

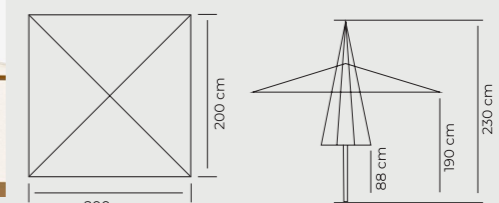

Salida de vientos / Wind exit / Sortie du vent

BASIC



- Blanco / White / Blanc [2 pcs]
- Aluminio (Ø48 mm) Pared (1 mm) / Aluminium (Ø48 mm) Wall (1 mm) / Aluminium (Ø48 mm) Épaisseur (1 mm)
- 8 uds aluminio / 8 pcs aluminium / 8 pièces aluminium
- TH30 - TH137 - MP40 - HSB40
- Olefin 190, Acrylic Basic & Acrylic Masa Soft

897 PATIO 2,5x2,5 m

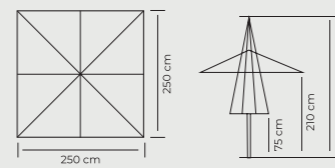

898 PLAZA 3x3 m

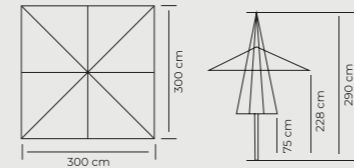

885 ZOCO 2x3 m

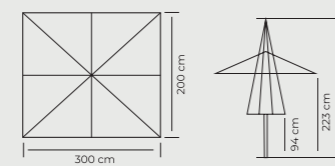

886 RUEDO Ø3 m

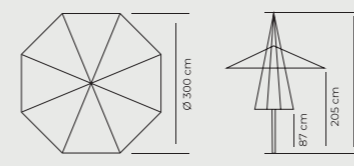

Salida de vientos / Wind exit / Sortie du vent



FORTE

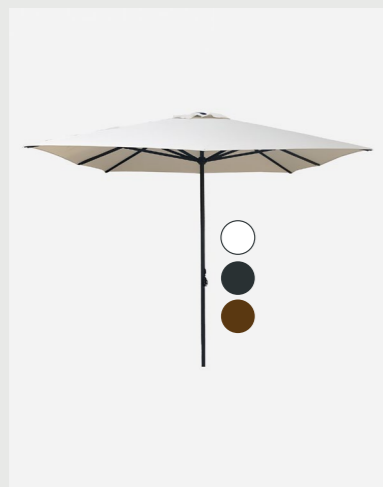

- Blanco / White / Blanc [1 pc]
- Antracita / Anthracite / Anthracite [1 pc]
- Café / Coffee / Café [1 pc]
- Aluminio (Ø50 mm) Pared (1,5 mm) / Aluminium (Ø50 mm) Wall (1,5 mm) / Aluminium (Ø50 mm) Épaisseur (1,5 mm)
- 8 uds aluminio (20x30 cm) Pared (1,1 mm) / 8 pcs aluminium (20x30 mm) Wall (1,1 mm) / 8 pièces aluminium (20x30 mm) Épaisseur (1,1 mm)
- MP40 - LTH50 - 50ET - 245
- Polyester beige, Olefin 190, Acrylic Basic, Acrylic Masa Soft & Acrylic Masa Forte
- Calefactores, iluminación, canal de unión, Ripstop (F/XR-PC01) & Multitex (103.1588) / Heaters, lighting, rain gutter, Ripstop (F/XR-PC01) & Multitex (103.1588) / Chauffages, éclairage, gouttières, Ripstop (F/XR-PC01) & Multitex (103.1588)

876 HEAVY DUTY Ø3 m

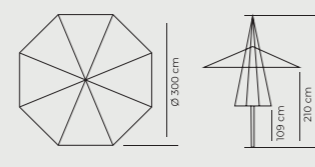

887 HEAVY DUTY 2x3 m

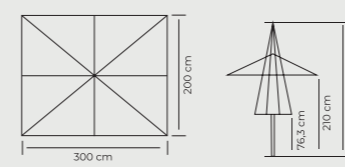

899 HEAVY DUTY 3x3 m

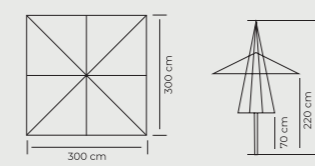

895 HEAVY DUTY 3,5x3,5 m

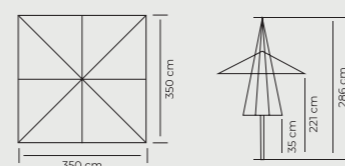

Salida de vientos / Wind exit / Sortie du vent
*Consultar adaptación con medidas especiales

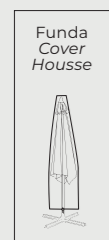

FORTE

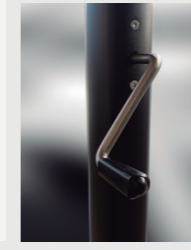
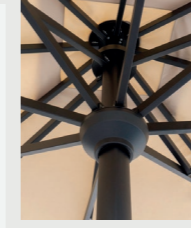

- Blanco / White / Blanc [1 pc]
- Antracita / Anthracite / Anthracite [1 pc]
- Aluminio (71x71 mm) Pared (3,1 mm) / Aluminium (71x71 mm) Wall (3,1 mm) / Aluminium (71x71 mm) Épaisseur (3,1 mm)
- 8 uds aluminio (20x35 mm) Pared (1,5 mm) / 8 pcs aluminium (20x35 mm) Wall (1,5 mm) / 8 pièces aluminium (20x35 mm) Épaisseur (1,5 mm)
- Doble varilla interior para reforzar uniones / Double inner rod to reinforce joints / Double tige intérieure pour renforcer les unions
- SHBC+4 losetas - ET70 - 245/90 - BASEMP01M/R
- Polyester PU 300 gr, Olefin 250 & Acrylic Masa Forte
- Calefactores, iluminación, canal de unión, cortinas & Funda (F/865P30) / Heaters, lighting, rain gutter, curtains & Cover (F/865P30) / Chauffages, éclairage, gouttières, rideaux & Housses (F/865P30)

889 MASTER 3x3 m

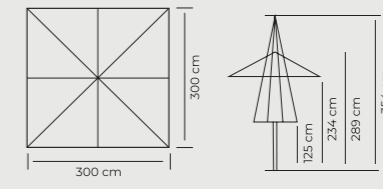

884 MASTER 3x4 m

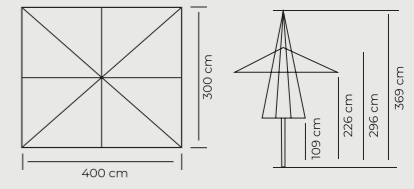

894 MASTER 4x4 m

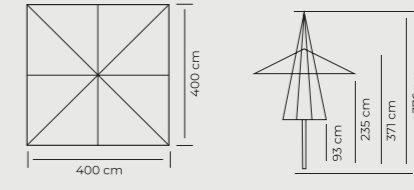

Salida de vientos / Wind exit / Sortie du vent
*Consultar adaptación con medidas especiales



FORTE

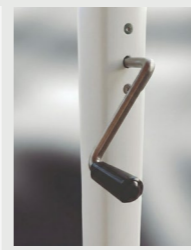

- Blanco / White / Blanc [1 pc]
- Antracita / Anthracite / Anthracite [1 pc]
- Aluminio (71x71 mm) / Aluminium (71x71 mm) / Aluminium (71x71 mm)
- 5 uds aluminio (20x35 mm) Pared (1,5 mm) / 5 pcs aluminium (20x35 mm) Wall (1,5 mm) / 5 pièces aluminium (20x35 mm) Épaisseur (1,5 mm)
- BASE 260-16 - SHBC+4 losetas - ET70 - BASEMP01M/R - 245/90
- Polyester PU 300 gr, Olefin 250 & Acrylic Masa Forte

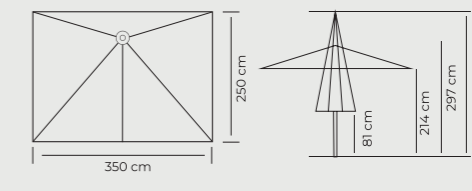

Salida de vientos / Wind exit / Sortie du vent



LATERAL | 3x3 m

REF. 878

BASIC



- Blanco / White / Blanc [1 pc]
- Aluminio (Ø65 mm) Pared (1,2 mm) / Aluminium (Ø65 mm) Wall (1,2 mm) / Aluminium (Ø65 mm) Épaisseur (1,2 mm)
- 8 uds aluminio (14x20 mm) / 8 pcs aluminium (14x20 mm) / 8 pièces en aluminium (14x20 mm)
- 4 losas CDLC30 - 4 losas DTH25
- Polyester beige, Olefin 190, Acrylic Basic & Acrylic Masa Soft
- Calefactores, iluminación, Ripstop (F/XR-PL02) & Multitex (103.1587) / Heaters, Lighting, Ripstop (F/XR-PL02) & Multitex (103.1587) / Chauffages, éclairage, Ripstop (F/XR-PL02) & Multitex (103.1587)

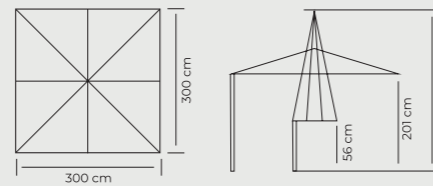

Salida de vientos / Wind exit / Sortie du vent



LATERAL PLUS | 3x3 m

REF. 879

FORTE



- Blanco / White / Blanc [1 pc] ● Antracita / Anthracite / Anthracite [1 pc]
- Aluminio (80x65 mm) Pared (2,5 mm) / Aluminium (80x65 mm) Wall (2,5 mm) / Aluminium (80x65 mm) Épaisseur (2,5 mm)
- 8 uds aluminio (14x28 mm) / 8 pcs aluminium (14x28 mm) / 8 pièces en aluminium (14x28 mm)
- 4 losas CDLC30 - 4 losas DTH25
- Olefin 190, Polyester PU, Acrylic Basic & Acrylic Masa Soft
- Calefactores, iluminación, Ripstop (F/XR-PL02) & Multitex (103.1587) / Heaters, Lighting, Ripstop (F/XR-PL02) & Multitex (103.1587) / Chauffages, éclairage, Ripstop (F/XR-PL02) & Multitex (103.1587)

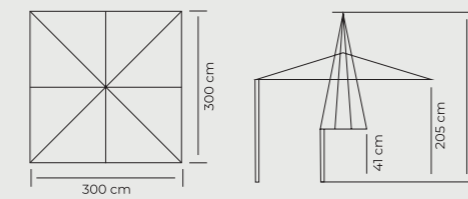

Salida de vientos / Wind exit / Sortie du vent



LATERAL DOBLE | 3x6 m

REF. 881

FORTE

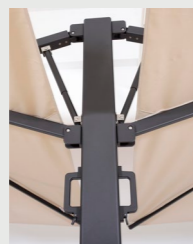
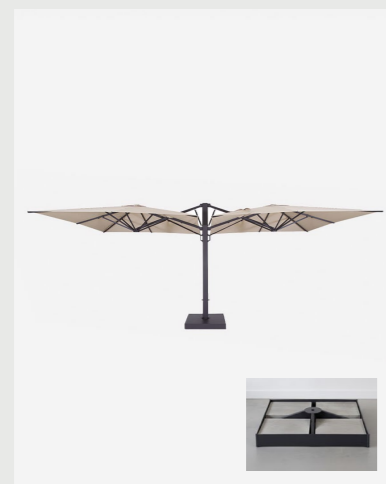

- Antracita / Anthracite / Anthracite [1 pcs]
- Aluminio 6063 (100x75 mm) Pared (2 mm) / Aluminium (100x75 mm) Wall (2 mm) / Aluminium (100x75 mm) Épaisseur (2 mm)
- 8 uds aluminio de (28x16 mm) Pared (1,2 mm) / 8 pcs aluminium de (28x16 mm) Wall (1,2 mm) / 8 pièces aluminium (28x16 mm) Épaisseur (1,2 mm)
- CMBC-G + 12 losas CDLC40 / EMP-BASE88
- Olefin & Acrylic Masa Soft

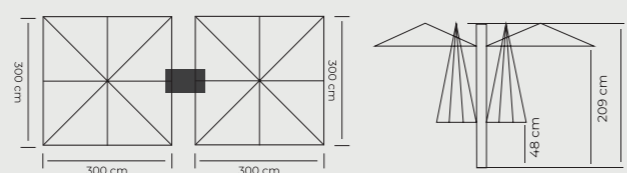

Salida de vientos / Wind exit / Sortie du vent



GIANT | 4x4m & 5x5 m *

REF. 864/865

FORTE

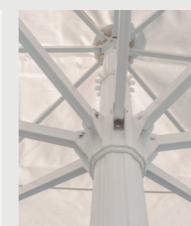

- Blanco / White / Blanc [1 pc] ● Antracita / Anthracite / Anthracite [1 pc]
- Aluminio (Ø86 mm) Pared (2,5 mm) / Aluminium (Ø86 mm) Wall (2,5 mm) / Aluminium (Ø86 mm) Épaisseur (2,5 mm)
- 8 uds aluminio (20x35 mm) Pared (2 mm) / 8 pcs aluminium (20x35 mm) Wall (2 mm) / 8 pièces aluminium (20x35 mm) Épaisseur (2 mm)
- **Incluido:** Acople metálico de fijación con tapa / Optional recessed base with hinge (EMP-BASE86) / Inclus l'accouplement de fixation métallique avec le capuchon
- **Opcional:** Base empotrable con bisagra (EMP-BASE86) / Including metal fixing coupling with cap / Base encastrable optionnelle avec charnière (EMP-BASE86)
- Olefin 250, Polyester PU 300 gr & Acrylic Masa Forte
- Calefactores, iluminación, canal de unión, cortinas & Funda (F/865P30) / Heaters, lighting, rain gutter, curtains & Cover (F/865P30) / Chauffages, éclairage, gouttières, rideaux & Housse (F/865P30)

*Consultar adaptación con medidas especiales

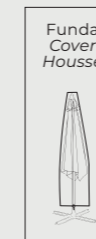

864 GIANT 4x4 m

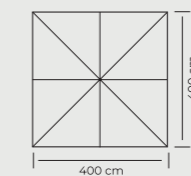

865 GIANT 5x5 m

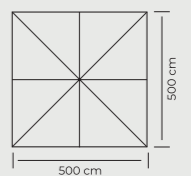

MADERA | Ø2, Ø3, 2x2 3x3 m

REF. 841/842/843/844

FORTE



- Madera Haya / Beech wood / Bois de hêtre [1 pc]
- 841: Ø38 mm / 842: Ø48 mm / 843: Ø48 mm / 844: Ø48 mm
- 841: 8 uds de 17x22 mm / 842: 8 uds de 20x28 mm / 843: 8 uds de 20x28 mm / 844: 8 uds de 20x28 mm
- TH30 - TH137 - MP40 - HS40
- Olefin 190, Acrylic Basic & Acrylic Masa Soft
- Calefactores, iluminación, canal de unión, Ripstop (F/XR-PC01) & Multitex (103.1588) / Heaters, lighting, rain gutter, Ripstop (F/XR-PC01) & Multitex (103.1588) / Chauffages, éclairage, gouttières, Ripstop (F/XR-PC01) & Multitex (103.1588)



841 MADERA Ø2 m

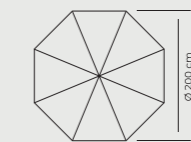

843 MADERA Ø3 m

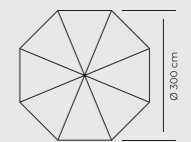

842 MADERA 2x2 m

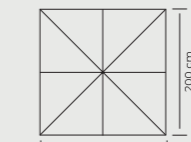

844 MADERA 3x3 m

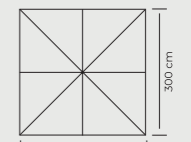

CERRAMIENTOS

CURTAIN ENCLOSURES / RIDEAUX

Cortina universal para parasoles, de medida estándar en 2,3,4, y 5 m de ancho. Con doble perfil de aluminio, superior e inferior con faldón. Consultar medidas especiales. / Universal curtain for sunshades, standard sizes in 2,3,4, and 5 m wide. With double aluminum profile, upper and lower with skirt. Consult special sizes. / Rideau universel, dimensions standard en 2, 3, 4 et 5 m de largeur. Avec double raidisseur en aluminium, supérieur et inférieur. Bavette incluse. Autres dimensions possibles.

Adaptable en diferentes productos y lugares (parasoles, porches...) / Adaptable to different products and locations (parasols, porches...) / Adaptable à différents produits et emplacements (parasols, porches...)

PVC transparente + PVC color crudo
 PVC transparente + Acrylic Masa Forte
 PVC transparente + Olefin

PARASOLES MÁSTER Ó SIMILARES CON FIJACIÓN SUELO | *MEDIDAS APROXIMADAS*
 Altura 2,05 m + 6 cm anclajes

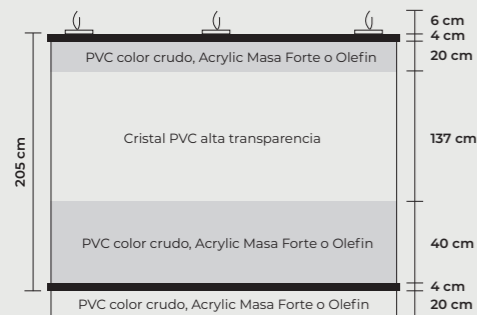

PARASOLES GIANT Y MÁSTER CON BASE DE CRUZ (SHBC) | *MEDIDAS APROXIMADAS*
 Altura 2,22 m + 6 cm anclajes

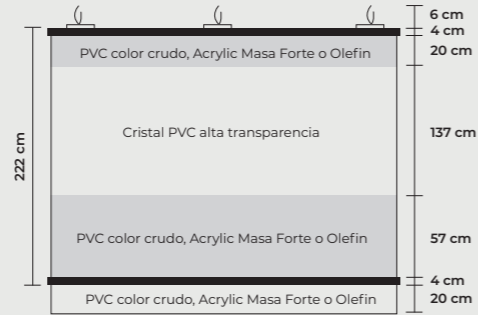

CANALES VIERTEAGUAS

El canal vierteaguas es adaptable a parasoles estandar de 2,3,4 y 5 metros. Medidas especiales. Este canal une los parasoles y evita que el agua de la lluvia caiga entre ambos, incluye perfiles y herrajes para su montaje. / The rain gutter is adaptable to standard sunshades of 2,3,4 and 5 meters. Special sizes. This gutter joins the parasols and prevents rainwater from falling between them, includes profiles and hardware for assembly. / La gouttière est adaptable aux parasols standards de 2,3,4 et 5 mètres. Autres dimensions possibles. Cette gouttière relie les parasols et empêche l'eau de passer au milieu. Sont inclus les raidisseurs et la visserie pour le montage.

Ancho estándar 34/48 cm para: 2,3,4 y 5 m / Standard width 34/48 cm for: 2,3,4 and 5 m / Dimension (largeur standard 34/48): 2,3,4 et 5 m

Acrylic Masa Forte, Olefin, PVC

BASES DE PARASOL

PIEDS DE PARASOLS

TH11 | 11 kg



Cemento pintado / Painted concrete / Ciment peint
 Ø30-38 mm

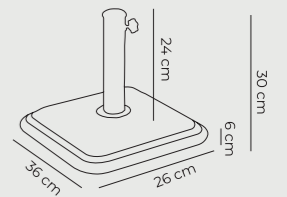

TH22 | 22 kg



Cemento pintado / Painted concrete / Ciment peint
 Ø38-48 mm

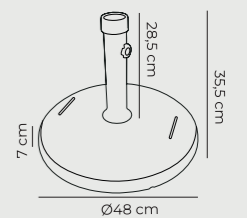

TH30 | 30 kg



Cemento pintado / Painted concrete / Ciment peint
 Ø38-48 mm

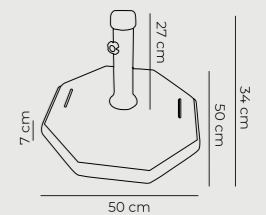

TH137 | 37 kg



Cemento pintado / Painted concrete / Ciment peint
 Ø38-48 mm

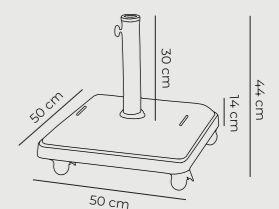

LTH50 | 50 kg

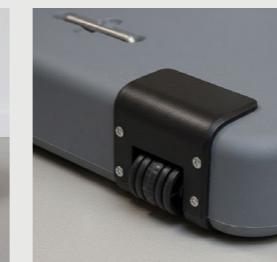

Cemento pintado / Painted concrete / Ciment peint
 Ø40-58 mm

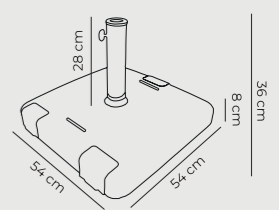

HSB40/HSN40 | 40 kg ● ○



Cemento carcasa de resina / Concrete plastic casing / Ciment avec carcasse résina
 Ø21-54 mm

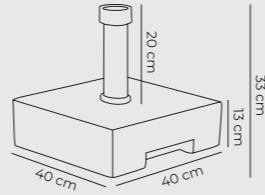

HS15/HS20 | 15/20 kg ○



Cemento carcasa de resina / Concrete plastic casing / Ciment avec carcasse résina
 HS15: Ø40x9 cm / HS20: Ø40x12 cm
 HS15: Ø21-35 cm / HS20: Ø21-54 cm

MV39 | 39 kg ●



Cemento carcasa de resina / Concrete plastic casing / Ciment avec carcasse résina
 Ø18-53 mm

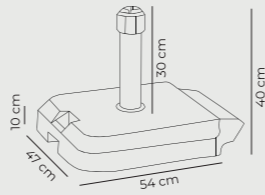

MP20/MP40 | 20/40 kg ● ○ ●



Plancha metálica en acero galvanizado / Galvanized steel metal plate /
 Plaque métallique en acier galvanisé
 MP20: Ø40 mm / MP40: Ø40 mm

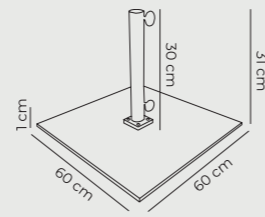

BASEMP01M/R | 58 kg ●



Metálica acero galvanizado / Galvanized steel / Acier galvanisé
 Ø63 mm (Master & Giant 4x4m)

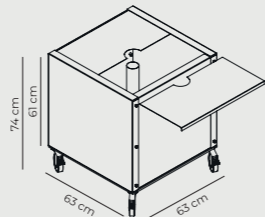

245/245-90 | 7,22/8,18 kg ● ○



Metálica acero / Steel metal / Métal acier
 245: hasta Ø50 mm / 245-90: hasta Ø90 mm

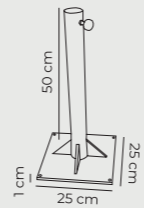

CMBC-G ●



Metálica acero galvanizado / Galvanized steel / Acier galvanisé
PARASOL: Noon

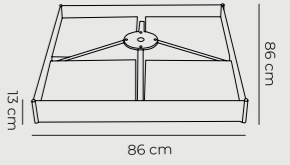

Sin losas: 28 kg / Con losas de cemento: 168 kg

BASE260-16 | 47 kg ●

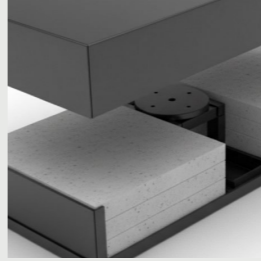

Metálica acero galvanizado / Galvanized steel / Acier galvanisé
 Ø260x16 mm
PARASOL: Master desplazado

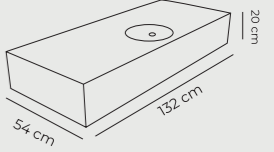

BASE CRUZ (SHBC) | 14 kg ● ○



Metálica acero galvanizado / Galvanized steel / Acier galvanisé
 71x71 mm
PARASOL: Master & Master descentrado

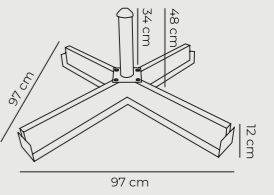

CDLC | 30 kg & 11,8 kg



Losa de cemento / Concrete slab / Dalle en béton

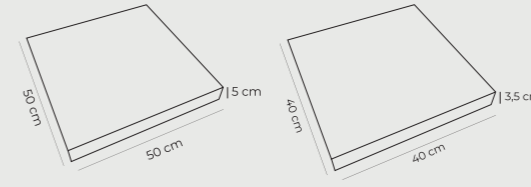

DTH25 | 25 kg



Losa de cemento pintado / Painted concrete slab /
 Dalle en béton peint

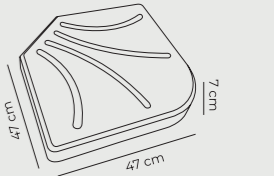

50ET/70ET | 3/4 kg



Metálica acero galvanizado / Galvanized steel / Acier galvanisé
 50ET: Ø48-50 mm / 70ET: Ø65 mm (Master)

EMP-BASE86 | 10.3 kg



Metálica acero / Steel metal / Métal acier
PARASOL: Giant

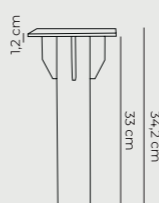

EMP-BASE88 | 6 kg



Metálica acero galvanizado / Galvanized steel /
 Acier galvanisé
PARASOL: Lateral Doble

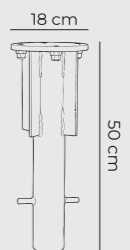

COMPLEMENTOS

SÉPARATEUR D'ESPACES

LÁMPARA CARBONO | REF. EST20CA

CARBON LAMP / LAMPE DE CARBONE

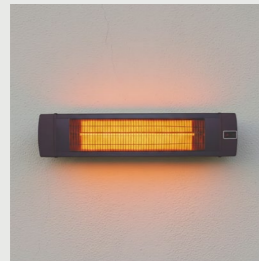

3 kg
 Color Negro/ Color Black/ Couleur noire
 Protección/Protection: IP55
 Potencia/Power/Puissance: 4

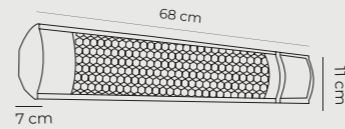

LÁMPARA HALÓGENA | REF. EST20HA

HALOGEN LAMP / LAMPE HALOGÈNE

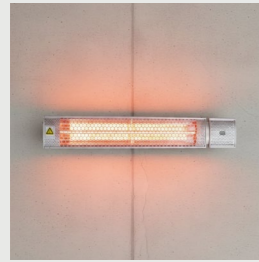

1,6 kg
 Color Gris / Color Grey/ Couleur Gris
 Protección/Protection: IP65
 Potencia/Power/Puissance: 2

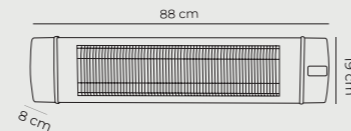

LÁMPARA HALÓGENA MINI | REF. EST20LG

MINI HALOGEN LAMP / MINI LAMPE HALOGÈNE

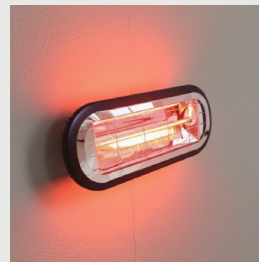

2,8 kg
 Color Negro/ Color Black/ Couleur noire
 Protección/Protection: IP65

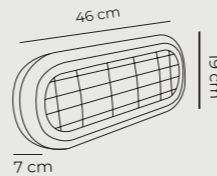

SOPORTE CALEFACTOR PIE | REF. EST-PIE

SOPORTE CALEFACTOR PARASOL | REF. EST-SOP



9 kg
 Ajustable de 1,2 a 2,1 m

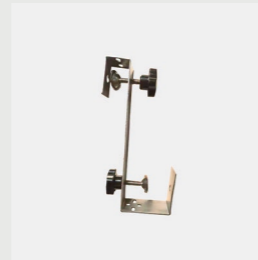

1,17 kg
 20,5x7,5x4 cm

ILUMINACIÓN LED | REF. ILED50-BAT / ILED50

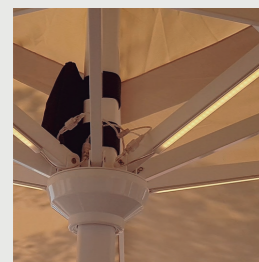

Opción: Luz cálida ó RGB
 Tira: 50 cm (x4 uds)

ILED50-BAT

Conexión/Connection/Connexion: Batería

ILED50

Conexión/Connection/Connexion: Red

FUNDAS PROTECTORAS



MULTITEX

Tejido fuerte y reciclable / Strong, recyclable fabric / Tissu résistant et recyclable

Medidas estandar y a medida / Standard and customised measurements / Mesures standard et sur mesure

Fabricación propia / In-house manufacturing / Fabrication propre



RIPSTOP

Tejido reciclable / Recyclable fabric / Tissu recyclable

Medidas estandar / Standard measurements / Mesures standard

SEPARADOR DE ESPACIOS

SÉPARATEUR D'ESPACES

SEPARADOR PLAYA | BS180



4,70 kg
 Acrylic Basic & Masa Soft
 Textilene & Olefin

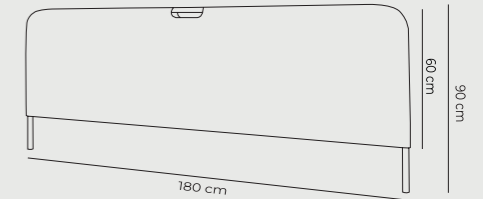

SEPARADOR TERRAZA | SPTZ150MS



6,30kg
 Acrylic Masa Soft

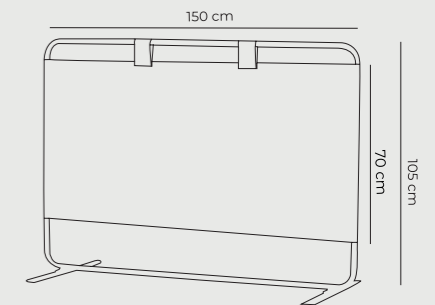

SEPARADOR TRANSPARENTE | SPR150PVC



7,24kg
 PVC

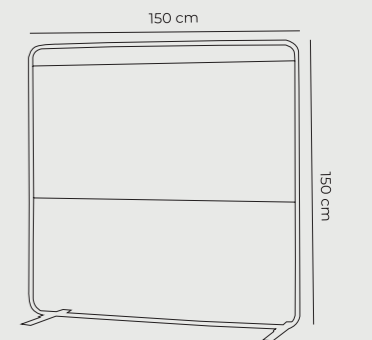

JARDINERA | SEPM100HCRE



38 kg
 Antracita / Anthracite / Anthracite [1 pc]
 Con o sin cristal / With or without glass / Avec ou sans verre

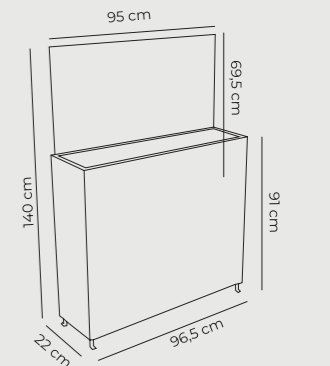

CARTA DE TEJIDOS



ACRYLIC BASIC



Para exterior e interior, con tratamiento repelente a los líquidos y la suciedad.

For indoor and outdoor, with liquid and dirt repellent treatment.

Pour extérieur et intérieur, avec traitement anti-liquides et anti-salissures.

COLORES ESTÁNDAR / STANDARD COLORS / COULEURS STANDARD



ACRYLIC MASA SOFT



Para exterior e interior, con tratamiento repelente a los líquidos y la suciedad. Alta solidez a la luz.

For indoor and outdoor, with liquid and dirt repellent treatment. High resistance to light.

Pour extérieur et intérieur, avec traitement anti-liquides et anti-salissures. Déperlant.



OLEFIN



Para exterior e interior, con tratamiento repelente a los líquidos y la suciedad. Alta solidez a la luz y al agua clorada.

For indoor and outdoor, with liquid and dirt repellent treatment. High resistance to light and chlorinated water.

Pour extérieur et intérieur, avec traitement anti-liquides et anti-salissures. Haute solidité à la lumière et à l'eau chlorée.

190 gr



250 gr



POLYESTER



Tejido beig estándar *Standard beige fabric* *Polyester beige standard*

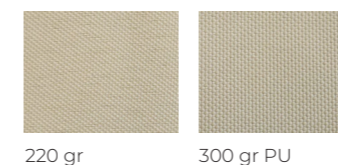

TRATAMIENTO GREEN

ACRYLIC MASA FORTE



Para exterior e interior, con tratamiento repelente a los líquidos y la suciedad. Alta solidez a la luz.

For indoor and outdoor, with liquid and dirt repellent treatment. High resistance to light.

Pour extérieur et intérieur, avec traitement anti-liquides et anti-salissures. Déperlant.

COLORES ESTÁNDAR / STANDARD COLORS / COULEURS STANDARD

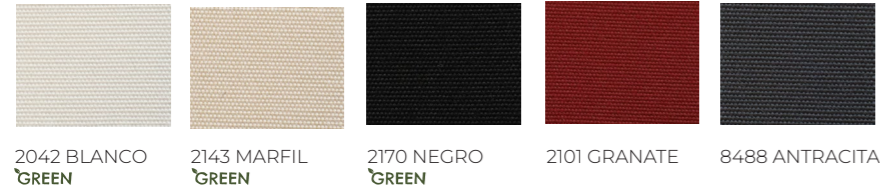

OTROS COLORES (CONSULTAR DISPONIBILIDAD) / OTHER COLORS (CHECK AVAILABILITY) / AUTRES COULEURS (VÉRIFIER LA DISPONIBILITÉ)

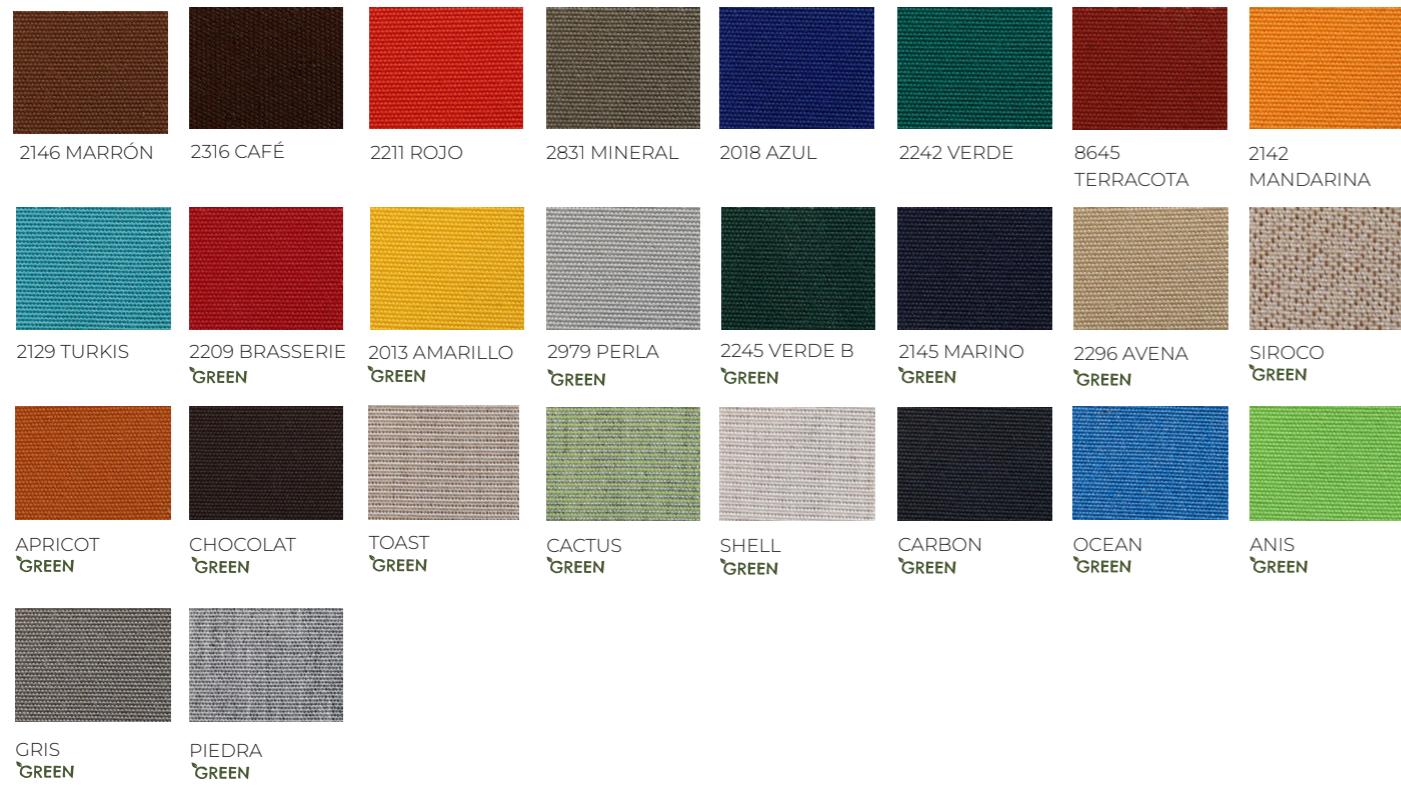

TEXTILENE



Para exterior, hilo de poliéster recubierto de PVC.

For outdoor use, PVC-coated polyester thread.

Pour utilisation en extérieur, fil de polyester enduit de PVC.



NAUTIC CLASS



NAUTIC BIO PLUS



NAUTIC MELANGE / TEXTURE

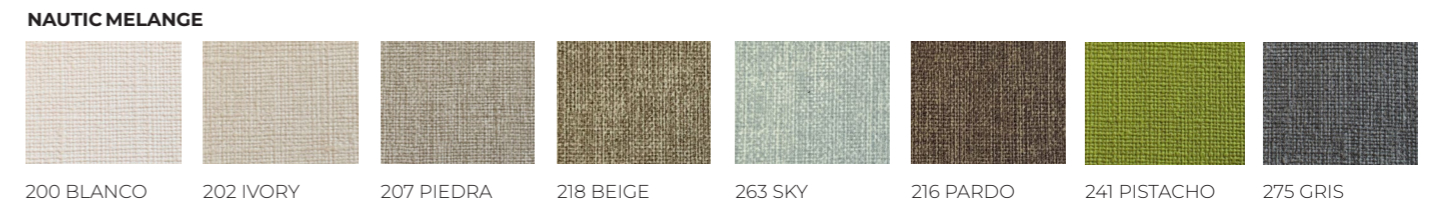

ESPECIFICACIONES TEJIDOS

	Acrylic Basic	Olefin	Polyester	Acrylic M. Soft	Acrylic M. Forte	Textilene	Nautic Class	Nautic BioPlus	Nautic Melange
Acabado: Finish: Finition:	Hidrófugo Water-repellent Hydrofugue	Hidrófugo Water-repellent Hydrofugue	Hidrófugo Water-repellent Hydrofugue	Hidrófugo Water-repellent Hydrofugue	Hidrófugo Water-repellent Hydrofugue	Permeable Permeable Perméable	Impermeable	Impermeable	Impermeable
Composición: Composition: Composition:	100% Dralón Dralon 100% Dralon 100%	100% Olefin Olefin 100% Olefin 100%	100% poliéster Polyester 100% Polyester 100%	100% Fibra acrilica tintada a la masa.	100% Fibra acrilica tintada a la masa.	Hilo de poliéster recubiero de PVC	90% vinilo / 10% poliéster	87% vinilo / 13% poliéster	90% vinilo / 10% poliéster
Peso: Wight: Poids:	195-220 gr/m ²	190-250 gr/m ²	220 / 300 gr/m ²	260 gr/m ²	300 gr/m ²	480 gr/m ²	700 gr/m ²	630 gr/m ²	830 gr/m ²
Resistencia U.V.: U.V. Resistance: U. V. Résistance:	CERTIFIED UV PROTECT 40 - 30	UV STANDARD 801 Blocks more than 97% of uv rays	-	1000 horas	-	-	1.300 horas	1.000 horas	1.000 horas
Solidez a luz: Light fastness: Solidité à la lumière:	6-7/8 (UNE EN ISO 105-B02:2001 Método 5)	5 años de garantía (en condiciones normales de exposición).	-	5 años de garantía (en condiciones normales de exposición).	10 años de garantía (en condiciones normales de exposición).	6-7/8	7 (ISO 105-B02)	7 (ISO 105-B02)	6 (ISO 105-B02)
Resistencia a la abrasión: Abrasion resistance: Résistance à l'abrasion:	20.000 cycles	20.000 cycles	-	28.000 cycles	NO TESTADO NOT TESTED PAS TESTÉ	NO TESTADO NOT TESTED PAS TESTÉ	EN ISO 12947-2:1998 >100.000 CICLOS	EN ISO 12947-2:1998 >100.000 CICLOS	EN ISO 12947-2:1999 >100.000 CICLOS
Resistencia a la tracción (urdimbre / trama): Breaking resistance (warp / weft): Résistance à la rupture (chaîne / trame):	NO TESTADO NOT TESTED PAS TESTÉ	1647 N / 750 N (UNE EN ISO 13934-1)	NO TESTADO NOT TESTED PAS TESTÉ	1600 N / 800 N 5 cm. ISO 13934-1	1400 N / 950 N 5 cm. UNE EN 1394.1	NO TESTADO NOT TESTED PAS TESTÉ	ISO 13934-1 N/ 5 cm ≥ 170	ISO 13934-1 N/ 5 cm ≥ 150	ISO 13934-1 N/ 5 cm ≥ 150
Alargamiento a la rotura (urdimbre / trama): Breaking elongation (warp / weft): Allongement à la rupture (chaîne / trame):	986 N / 525 N (UNE EN ISO 13936-1:1999)	-	NO TESTADO NOT TESTED PAS TESTÉ	28% / 18% ISO 13934-1	NO TESTADO NOT TESTED PAS TESTÉ	NO TESTADO NOT TESTED PAS TESTÉ	ISO 13934-1 ≥ 25% ≥ 50%	ISO 13934-1 ≥ 25% ≥ 50%	ISO 13934-1 ≥ 25% ≥ 50%
Resistencia al desgarro (urdimbre / trama): Tear resistance (warp / weft): Résistance au déchirement (chaîne / trame):	NO TESTADO NOT TESTED PAS TESTÉ	73,9 N / 43,2 N (UNE EN ISO 13937-3)	NO TESTADO NOT TESTED PAS TESTÉ	60 N / 50 N ISO 13937-2	NO TESTADO NOT TESTED PAS TESTÉ	NO TESTADO NOT TESTED PAS TESTÉ	ISO 13937-2 ≥ 35 N ≥ 50 N	ISO 13937-2 ≥ 25 N ≥ 40 N	ISO 13937-2 ≥ 35 N ≥ 50 N
Tratamiento ignífugo: Fire retardant treatment: Traitement ignifuge:	NO	NO	NO	NO	NO	NO	UNE 1021 Parts 1-2 IMO A652 B55852 Cigarette & Match	UNE 1021 Parts 1-2 IMO A652 B55852 Cigarette & Match	UNE 1021 Parts 1-2 IMO A652 B55852 Cigarette & Match
Tratamiento antibacteriano y antihongos: Antibacterial treatment and mildew resistance: Traitement antibactérien et résistance à la moisissure:	SI	NO	NO	SI	SI	NO	SI	SI	SI

La migración de pigmentos, tinturas y colorantes como los utilizados en el denim de algunos tejanos u otras prendas, es un efecto irreversible en esta tipología de productos, por lo que EXCLUSIVAS CONFORT VALLÉS, S.L. (CONVA) no puede asumir responsabilidad alguna en las manchas ocasionadas.

The migration of pigments, dyes and colorants like the ones used in some denim jeans or other clothes is an irreversible effect on this type of products, therefore EXCLUSIVAS CONFORT VALLÉS, S.L. (CONVA) cannot assume any responsibility for caused stains.

La migration des pigments, des colorants et des colorants comme ceux utilisés dans certains jeans en denim est un effet irréversible sur ce type de produits, donc EXCLUSIVAS CONFORT VALLÉS, S.L. (Conva) ne peut assumer aucune responsabilité pour les taches causées.



El primer tejido que purifica el aire

The first fabric that purifies the air / Le premier tissu qui purifie l'air



Sostenibilidad
Sustainability
Durabilité



Mejora la calidad del aire
Air quality improvement
Amélioration de la qualité de l'air



Autolimpiante
Self cleaning
Auto-nettoyant



[ES] Los tejidos tratados con este acabado, limpian y purifican el aire mediante la fotocatalisis.

[EN] Fabrics treated with this finish clean and purify the air by means of photocatalysis.

[FR] Les tissus traités avec cette finition nettoient et purifient l'air par la photocatalyse

Material / Fabric / Tissu		Acrílico Masa Forte Tintado en Masa 100%
Hilos / Yarns / Fils	Urdimbre / Warp / Chaîne	30h/cm (Nm 34/2)
	Trama / Weft / Trame	15h/cm (Nm 34/2)
Resistencia de tracción Tensile Strength Résistance à la traction	Urdimbre / Warp / Chaîne	140 daN/5 cm
	Trama / Weft / Trame	95 daN/5 cm
Peso / Weight / Poids		300 gr m ²
Repelencia del agua / Water Repellency / Déperlance		360 mm
Acabado / Finish / Finition		Green (TiO2 nanoparticles) Green (TiO2 nanoparticulas)

SPAIN

93 587 38 90

spain.division@conva.es

FRANCE/BELGIUM/SWITZERLAND

+34 637 564 111

france.division@conva.es

PORTUGAL

+351 917 623 102

portugal.division@conva.es

EUROPE (other countries)

europe.division@conva.es

LATINOAMERICA

latam.division@conva.es

MIDDLE EAST NORTH AFRICA

mena.division@conva.es

Avda. Antonio Gaudí, 57-61 - Polígono Industrial Rubí Sud
08191 Rubí (Barcelona-España)

www.conva.es

© Copyright 2026 Exclusivas Confort Valles S.L

