



DEGRENNE

Since 1948



2025



Plus de 75 ans après sa création, la Maison DEGRENNE, Fabricant Français d'arts de la table premium, est toujours une entreprise familiale gérée par la famille SPRUCH.

Les 4 frères de la famille : Antoine, Marc-Alain, Benjamin et Thomas, s'engagent tous les jours pour développer et réinventer cette Maison Française.

La Maison DEGRENNE perpétue, transmet et revisite les savoir-faire de ses artisans dans ses trois Manufactures : à Vire en Normandie pour les couverts et la platerie, en acier inoxydable et en métal argenté, à Limoges pour la porcelaine fine extra blanche et en Hongrie pour la porcelaine de couleur.

Dans ses Manufactures, DEGRENNE associe le meilleur des deux mondes : l'artisanat et l'industrie, en réinventant des gestes artisanaux et en les adaptant à un process industriel de moyennes séries.

Les savoir-faire des artisans orfèvres et porcelainiers des Manufactures DEGRENNE sont reconnus et sélectionnés par les plus exigeants : les plus beaux hôtels et restaurants, de Paris à New-York City en passant par Séoul, les Maisons de Luxe les plus prestigieuses, les grandes compagnies aériennes.

La famille SPRUCH et toutes les équipes de la Maison DEGRENNE sont fières de vous accompagner et de vous proposer dans ce catalogue ses collections de couverts, platerie, vaisselle et verrerie, qui marient qualité, intemporalité, design et usage. Ces collections DEGRENNE, toutes au service des Chefs, sont pensées et réalisées pour vous inspirer et pour mettre en valeur vos plus belles créations.

More than 75 years after its creation, the DEGRENNE House, a French manufacturer of premium tableware, remains a family-run business managed by the SPRUCH family.

The four brothers of the family : Antoine, Marc-Alain, Benjamin and Thomas commit themselves every day to developing and reinventing this French Maison.

DEGRENNE perpetuates, transmits, and revisits the expertise of its craftsmen in its three Manufactures: in Vire, Normandy, for cutlery and silverware in stainless steel and silver-plated metal in Limoges for extra-white fine porcelain and in Hungary for colored porcelain.

In its Manufactures, DEGRENNE combines the best of both worlds : craftsmanship and industry, reinventing artisanal gestures and adapting them to a medium-scale industrial process.

The know-how of the goldsmiths and porcelain makers in the DEGRENNE Manufactures is recognized and selected by the most demanding clientele : the finest hotels and restaurants from Paris to New York City to Seoul, as well as the most prestigious Luxury Houses and major airlines.

The SPRUCH family and all the teams at DEGRENNE are proud to accompany and present in this catalog their collections of cutlery, silverware, tableware, and glassware, which blend quality, timelessness, design, and functionality. DEGRENNE collections, all at the service of chefs, are designed and created to inspire you and showcase your most beautiful creations.

# PARTENAIRES D'EXCELLENCE

Partners of excellence



# ILS NOUS FONT CONFIANCE

They trust us

## **ACCOR HOTELS**

FAIRMONT  
PULLMAN  
RAFFLES  
SOFITEL /BARRIÈRE

## **AMAN RESORTS**

## **AUBERGE RESORTS**

## **ELEVEN MADISON PARK**

LE BERNARDIN

## **FOUR SEASONS**

## **HILTON WORLDWIDE**

## **INTERCONTINENTAL**

## **LOUVRE HOTELS**

GOLDEN TULIP

## **LUTETIA**

## **MANDARIN ORIENTAL**

## **MARRIOTT**

RITZ CARLTON  
ST REGIS HOTELS & RESORTS  
W HOTELS

## **MJM RESORTS**

BELLAGIO  
MJM GRAND  
ARIA

## **ONE AND ONLY RESORTS**

## **PENINSULA**

## **SOCIETE DES BAINS DE MER**

## **WALDORF ASTORIA**

## LE COUVERT FLATWARE

### CLASSIQUE CLASSICAL

ABSOLU	10-11
BLOIS	12-15
CONFIDENCE	16-17
CONTOUR	18-19
COUTEAUX STEAK	86-88
FLORENCIA	20-21
LE PHIL	86
<b>LE PHIL VINTAGE NEW</b>	86
LUTÈCE	22-23
MARQUISE	24-25
MIKADO MIROIR	26-27
MIKADO VINTAGE	28-29
MILADY	30-31
MIRAGE STEAK	86
MIRAGE LES ESSENCES	86
NEUILLY	32-33
NORMANDY	34-35
PETIT GOURMET	88
<b>SWELL NEW</b>	36-37
VERLAINE	38-39
VIEUX PARIS SATINÉ	40-41

### DESIGN

AQUATIC MIROIR	44-45
ASTRÉE CISELÉ	46-47
COUTURE	48-49
FUSE MIROIR	50-51
FUSE MARTELÉ	52-53
GUEST CUIVRE	56-57
GUEST MIROIR	54-55
GUEST STAR	58-59
GUEST VINTAGE	60-61
L'EMPREINTE	62-63
L'E STARCK®	64-65
NORWAY	66-67
ONDE MIROIR	68-69
ONDE GOLD	70-71
OVATION	72-73
<b>RIVAGE NEW</b>	74-75
SOLSTICE	76-77
SUPERNATURE	78-79
XY MIROIR	80-81
XY BLACK MIROIR	82-83

### PIÈCES COMPLÉMENTAIRES ADDITIONAL PIECES

ABSOLU	10-11
BLOIS	12-15
CONFIDENCE	16-17
CONTOUR	18-19
COUTEAUX STEAK	86-88
FLORENCIA	20-21
LE PHIL	86
<b>LE PHIL VINTAGE NEW</b>	86
LUTÈCE	22-23
MARQUISE	24-25
MIKADO MIROIR	26-27
MIKADO VINTAGE	28-29
MILADY	30-31
MIRAGE STEAK	86
MIRAGE LES ESSENCES	86
NEUILLY	32-33
NORMANDY	34-35
PETIT GOURMET	88
<b>SWELL NEW</b>	36-37
VERLAINE	38-39
VIEUX PARIS SATINÉ	40-41

## LA VAISSELLE DINNERWARE

### PORCELAINE DE LIMOGES LIMOGES PORCELAIN

ÉCLIPSE	106-107
GALON OR	108-109
GALON PLATINE	110-111
L	96-99
L COUTURE	100-101
L FRAGMENT	102-103
L PERLES DE ROSÉE	104-105
REMINISCENCE	112-113
SD ONE	114-115
SD ONE OR	114-115
SUPERNATURE	116-117
SUPERNATURE OR	116-117

### CÉRAMIQUE CERAMIC

BAHIA	120-125
BLUE SHADES	126-127
BORÉAL	128-129
<b>BORÉAL ONDE NEW</b>	130-131
BORÉAL SATIN BLANC	132-133
BORÉAL SATIN GOLD	132-133
BRUME	134-135
COCOTTES	136-139
<b>COURONNE DORÉE NEW</b>	140-141
<b>COURONNE ARGENTÉE NEW</b>	142-143
<b>ECLATS NEW</b>	140-141
GRAPHIQUE CLASSIQUE	144-145
GRAPHIQUE CLASSIQUE DORÉ	144-145
LA VAISSELLE DE LECONOME	146-147
MODULO	148-151
MODULO NATURE	152-157
RIVAGE	158-159

### CAFÉTERIE TEATIME

EMPILEO	168-169
BOREAL	176-177
BOREAL SATIN	176-177
COURONNE ARGENTÉ	178-179
COURONNE DORÉ	178-179
GALON OR	174-175
GALON PLATINE	174-175
GRAPHIQUE CLASSIQUE	180-181
GRAPHIQUE CLASSIQUE DORÉ	180-181
L	172
L COUTURE	172
L FRAGMENT	172
L PERLES DE ROSÉE	172
<b>MODULO NEW</b>	170
MODULO NATURE	184-185
NEWPORT	182-183
SALAM	162-165
SALAM MONOCHROME	166-167
SALAM THÉ	170-171
SD ONE	172

## LE VERRE GLASSWARE

### À PIED STEMMED GLASS

ALLURE	190-191
ANYTIME	192-193
DOMAINE	194-195
HYPNOTIC JAUGÉ	198
GALATÉE	196-197
MONTMARTRE	198-199
MONTMARTRE JAUGÉ	198
MUSE	200-201
NEWPORT TWIST	202-203
ORIGINE	192

### GOBELET ET CARAFE TUMBLER & CARAFE

ALLEGRO	206-207
ALLURE	190
COSMOPOLITAIN	208-209
CARAFES - DÉCANTEURS	214-215
DOLCE	208-209
EMPILEO	210-211
GALATEE	196
INSTANT	212
LOOP	212
MAMBO	213
MUSE	200
ROC	213

### LA PLATERIE HOLLOWARE

NEWPORT ACCESSOIRES	228-229
NEWPORT BAR	226-227
NEWPORT CAFÉTERIE	224-225
NEWPORT PLATEAUX CUBIQUE	220-221
NEWPORT PLATEAUX MIROIR	218-219
NEWPORT SERVICE À TABLE	222-223
NORMANDY	218

### LE BUFFET EVENTO

ACCESSOIRES	248-249
CHAFING DISHES	232-235
DISTRIBUTEURS À CÉRÉALES	241
MODULES FROIDS	236-239
PIÈCES DÉTACHÉES	252-253
PLAN	250-251
PLANCHES LES ESSENCES	246-247
SUPPORTS À FIL RECTANGULAIRES	243-245
SUPPORTS À FIL RONDS	243-245
URNES À JUS DE FRUITS	240

### LES BASIQUES BASIC'S

AMAZONE	256-257
BAR	256
CASSIOPEE	258-259
ESSENTIELLE	260-261
GLORIA	262-263
UNISSET	264-265
VITAL	266-267
UNI	268-271

**LES COLLECTIONS**  
RANGES





# LE COUVERT

Flatware

Les ateliers DEGRENNE donnent forme aux majestueuses bobines d'acier inoxydable et transforment la matière brute en couverts. Les couverts DEGRENNE bénéficient d'un savoir-faire unique et se caractérisent par une ergonomie et une résistance exceptionnelle.

Faciles d'entretien, ils répondent aux critères les plus exigeants de qualité, de fonctionnalité et d'esthétique. La qualité du design et le soin apporté aux finitions font de chacun de nos couverts de véritables pièces d'orfèvre de style classique ou contemporain. Créé en collaboration avec des chefs ou en laissant libre cours à l'imagination de nos designers, aux lignes sobres ou plus élaborées, chaque modèle DEGRENNE trouve sa place à table.

DEGRENNE'S workshops shape the impressive reels of stainless steel and transform the raw material into cutlery. We use our unique expertise to create our cutlery, which is characterized by being extraordinarily easy to use and sturdy. DEGRENNE cutlery is easy to look after and meets the most stringent quality, functionality and appearance criteria. The design quality and painstaking finishes make each of our items of cutlery true pieces of classic or contemporary silverware. DEGRENNE cutlery is designed in partnership with chefs or by giving our designers free rein. Some items have simple lines, while others are more elaborate, but every DEGRENNE design takes pride of place on a table.

Découvrez les coulisses de notre Manufacture à Vire  
Discover our factory in Vire





# **LE COUVERT CLASSIQUE**

Classical Flatware



**126556**  
**FOURCHETTE DE TABLE**  
TABLE FORK  
20,2 CM - 7 IN<sup>15/16</sup>



**126578**  
**FOURCHETTE À POISSON**  
FISH FORK  
18 CM - 7 IN<sup>1/16</sup>



**126565**  
**COUTEAU DE TABLE**  
**MANCHE ORFÈVRE LAME UNIE**  
TABLE KNIFE HOLLOW HANDLE  
23 CM - 9 IN<sup>1/16</sup>



**126581**  
**COUTEAU À POISSON**  
FISH KNIFE  
20,1 CM - 7 IN<sup>15/16</sup>



**130332**  
**COUTEAU DE TABLE**  
**MANCHE ORFÈVRE LAME SCIE**  
TABLE KNIFE HOLLOW HANDLE SERRATED  
23 CM - 9 IN<sup>1/16</sup>



**126559**  
**CUILLÈRE À CAFÉ**  
COFFEE/TEA SPOON  
13,9 CM - 5 IN<sup>1/2</sup>



**126553**  
**CUILLÈRE DE TABLE**  
TABLE/PASTA SPOON  
20,5 CM - 8 IN<sup>1/16</sup>



**155452**  
**CUILLÈRE À MOKA**  
DEMI TASSE SPOON  
11,1 CM - 4 IN<sup>3/8</sup>



**155528**  
**CUILLÈRE À SOUPE ANGLAISE**  
BOUILLON SPOON, ROUND  
17,5 CM - 6 IN<sup>7/8</sup>



**126591**  
**FOURCHETTE DE SERVICE**  
SERVING FORK  
24,8 CM - 9 IN<sup>3/4</sup>



**126569**  
**CUILLÈRE À DESSERT**  
DESSERT/SOUP SPOON, OVAL  
18 CM - 7 IN<sup>1/16</sup>



**126589**  
**CUILLÈRE DE SERVICE**  
SERVING SPOON  
25 CM - 9 IN<sup>13/16</sup>



**126572**  
**FOURCHETTE À DESSERT**  
DESSERT/SALAD FORK  
18 CM - 7 IN<sup>1/16</sup>



**126587**  
**PELLE À TARTE**  
**MANCHE ORFÈVRE**  
PASTRY SERVER HOLLOW HANDLE  
24 CM - 9 IN<sup>7/16</sup>



**126575**  
**COUTEAU À DESSERT**  
**MANCHE ORFÈVRE LAME UNIE**  
DESSERT KNIFE HOLLOW HANDLE  
20,5 CM - 8 IN<sup>1/16</sup>



**154828**  
**COUTEAU À BEURRE**  
**MANCHE ORFÈVRE LAME UNIE**  
BUTTER KNIFE HOLLOW HANDLE  
18,8 CM - 7 IN<sup>3/8</sup>

EGALEMENT DISPONIBLE EN MÉTAL ARGENTÉ  
ALSO AVAILABLE IN SILVERPLATED FINISH



Possibilité de personnalisation  
Bespoke options available



# ABSOLU

Finedining





**104485**  
**FOURCHETTE DE TABLE**  
TABLE FORK  
20,8 CM - 8 IN<sup>3/16</sup>



**182466**  
**COUTEAU DE TABLE**  
**MONOBLOC LOURD LAME SCIE**  
TABLE KNIFE HEAVY SOLID HANDLE  
SERRATED  
24,6 CM - 9 IN<sup>11/16</sup>



**161390**  
**COUTEAU DE TABLE**  
**MANCHE ORFÈVRE LAME UNIE**  
TABLE KNIFE HOLLOW HANDLE  
24,6 CM - 9 IN<sup>11/16</sup>



**161391**  
**COUTEAU DE TABLE**  
**MANCHE ORFÈVRE LAME SCIE**  
TABLE KNIFE HOLLOW HANDLE SERRATED  
24,6 CM - 9 IN<sup>11/16</sup>



**122759**  
**COUTEAU À STEAK**  
**MANCHE ORFÈVRE LAME SCIE**  
STEAK KNIFE HOLLOW HANDLE SERRATED  
23,9 CM - 9 IN<sup>7/16</sup>



**104526**  
**CUILLÈRE DE TABLE**  
TABLE/PASTA SPOON  
20,8 CM - 8 IN<sup>3/16</sup>



**104448**  
**CUILLÈRE À SOUPE ANGLAISE**  
BOUILLON SPOON, ROUND  
17,2 CM - 6 IN<sup>3/4</sup>



**104484**  
**CUILLÈRE À DESSERT**  
DESSERT/SOUP SPOON, OVAL  
18 CM - 7 IN<sup>1/16</sup>



**104543**  
**FOURCHETTE À DESSERT**  
DESSERT/SALAD FORK  
17,8 CM - 7 IN



**182467**  
**COUTEAU À DESSERT**  
**MONOBLOC LOURD LAME UNIE**  
DESSERT KNIFE HEAVY SOLID HANDLE  
20,5 CM - 8 IN<sup>1/16</sup>



**161394**  
**COUTEAU À DESSERT**  
**MANCHE ORFÈVRE LAME UNIE**  
DESSERT KNIFE HOLLOW HANDLE  
20,5 CM - 8 IN<sup>1/16</sup>



**190419**  
**COUTEAU À BEURRE**  
**MONOBLOC LOURD LAME UNIE**  
BUTTER KNIFE HEAVY SOLID HANDLE  
18,7 CM - 7 IN<sup>3/8</sup>



**122760**  
**COUTEAU À BEURRE**  
**MANCHE ORFÈVRE LAME UNIE**  
BUTTER KNIFE HOLLOW HANDLE  
18,7 CM - 7 IN<sup>3/8</sup>

EGALEMENT DISPONIBLE EN MÉTAL ARGENTÉ  
ALSO AVAILABLE IN SILVERPLATED FINISH



Possibilité de personnalisation  
Bespoke options available

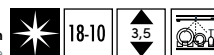

BLOIS

Finedining



MADE IN FRANCE





**104507**  
**FOURCHETTE POISSON**  
FISH FORK  
17,7 CM - 6 IN<sup>15/16</sup>



**104508**  
**COUPEAU POISSON**  
FISH KNIFE  
19,9 CM - 7 IN<sup>13/16</sup>



**145451**  
**CUILLÈRE À SAUCE GOURMET**  
GOURMET/SAUCE SPOON  
17,9 CM - 7 IN<sup>1/16</sup>



**104561**  
**CUILLÈRE À CAFÉ**  
COFFEE/TEA SPOON  
14 CM - 5 IN<sup>1/2</sup>



**109465**  
**CUILLÈRE À MOKA MIKADO**  
DEMI TASSE SPOON  
11 CM - 4 IN<sup>5/16</sup>



**124259**  
**CUILLÈRE À SODA**  
ICED TEA SPOON  
18,2 CM - 7 IN<sup>3/16</sup>



**104480**  
**FOURCHETTE À GÂTEAUX/ COCKTAIL**  
PASTRY/COCKTAIL FORK  
13,8 CM - 5 IN<sup>7/16</sup>



**104463**  
**FOURCHETTE À HUITRES**  
OYSTER FORK  
13 CM - 5 IN<sup>3/8</sup>



**189208**  
**COUPEAU À FROMAGE MANCHE ORFÈVRE LAME UNIE**  
CHEESE KNIFE HOLLOW HANDLE  
19,3 CM - 7 IN<sup>5/8</sup>



**195757**  
**FOURCHETTE DE SERVICE**  
SERVING FORK  
24,8 CM - 9 IN<sup>3/4</sup>



**195755**  
**CUILLÈRE DE SERVICE**  
SERVING SPOON  
25 CM - 9 IN<sup>13/16</sup>



**195757**  
**FOURCHETTE À DÉCOUPER**  
CARVING FORK  
24,8 CM - 9 IN<sup>3/4</sup>



**189511**  
**COUPEAU À DÉCOUPER MANCHE ORFÈVRE LAME UNIE**  
CARVING KNIFE HOLLOW HANDLE  
28,7 CM - 11 IN<sup>5/16</sup>



**195750**  
**SERVICE À SALADE**  
SALADE SERVING SET  
25,7 CM - 10 IN<sup>1/8</sup>



**195753**  
**PELLE À TARTE MONOBLOC**  
PASTRY SERVER SOLID HANDLE  
24,9 CM - 9 IN<sup>13/16</sup>



**195762**  
**LOUCHE**  
SOUP LADLE  
29,8 CM - 11 IN<sup>3/4</sup>



**195759**  
**LOUCHE À SAUCE**  
SAUCE LADLE  
15,7 CM - 6 IN<sup>3/16</sup>

EGALEMENT DISPONIBLE EN MÉTAL ARGENTÉ  
ALSO AVAILABLE IN SILVERPLATED FINISH



Possibilité de personnalisation  
Bespoke options available





# BLOIS

Finedining

  
MADE IN FRANCE





**141094**  
**FOURCHETTE DE TABLE**  
TABLE FORK  
20,3 CM - 8 IN



**103857**  
**COUTEAU DE TABLE**  
**MONOBLOC LAME SCIE**  
TABLE KNIFE SOLID HANDLE  
SERRATED  
23,7 CM - 9 IN<sup>5/16</sup>



**160433**  
**COUTEAU À STEAK**  
**MONOBLOC LAME SCIE**  
STEAK KNIFE SOLID HANDLE SERRATED  
23,6 CM - 9 IN<sup>5/16</sup>



**141092**  
**CUILLÈRE DE TABLE**  
TABLE/PASTA SPOON  
20,4 CM - 8 IN<sup>1/16</sup>



**105908**  
**CUILLÈRE À SOUPE ANGLAISE**  
**VERLAINE**  
BOUILLON SPOON, ROUND  
17,2 CM - 6 IN<sup>3/4</sup>



**108232**  
**CUILLÈRE À DESSERT**  
DESSERT/SOUP SPOON, OVAL  
17,9 CM - 7 IN<sup>7/16</sup>



**108234**  
**FOURCHETTE À DESSERT**  
DESSERT/SALAD FORK  
17,8 CM - 7 IN



**210628**  
**COUTEAU À DESSERT**  
**MONOBLOC LAME SCIE**  
DESSERT KNIFE SOLID HANDLE  
20,6 CM - 8 IN<sup>1/8</sup>



**103564**  
**CUILLÈRE À CAFÉ**  
COFFEE/TEA SPOON  
13,5 CM - 5 IN<sup>5/16</sup>



**109471**  
**CUILLÈRE À MOKA**  
DEMI TASSE SPOON  
11 CM - 4 IN<sup>5/16</sup>



**105800**  
**CUILLÈRE À SODA**  
**VERLAINE**  
ICED TEA SPOON  
18,2 CM - 7 IN<sup>3/16</sup>



**132782**  
**FOURCHETTE À ESCARGOTS**  
SNAIL FORK  
13,5 CM - 5 IN<sup>5/16</sup>

**SUGGESTION PIÈCES DE SERVICE**  
SUGGESTED SERVING PIECES  
**VERLAINE**



**002185**  
**FOURCHETTE DE SERVICE**  
SERVING FORK  
24,8 CM - 9 IN<sup>3/4</sup>



**002186**  
**CUILLÈRE DE SERVICE**  
SERVING SPOON  
25 CM - 9 IN<sup>13/16</sup>



**040646**  
**SERVICE À SALADE**  
SALAD SERVING SET  
25,8 CM - 10 IN<sup>3/16</sup>



**083340**  
**PELLE À TARTE MONOBLOC**  
PASTRY SERVER SOLID HANDLE  
24,9 CM - 9 IN<sup>3/16</sup>



**097717**  
**LOUCHE**  
SOUP LADLE  
29,8 CM - 11 IN<sup>3/4</sup>



**002179**  
**LOUCHE À SAUCE**  
SAUCE LADLE  
15,7 CM - 6 IN<sup>3/16</sup>

ÉGALEMENT DISPONIBLE EN MÉTAL ARGENTÉ  
ALSO AVAILABLE IN SILVERPLATED FINISH



Possibilité de personnalisation  
Bespoke options available



# CONFIDENCE

---

Alldaydining





**104729**  
**FOURCHETTE DE TABLE**  
 TABLE FORK  
 21 CM - 8 IN<sup>3/4</sup>



**104728**  
**COUTEAU DE TABLE**  
**MANCHE ORFEVRE LAME SCIE**  
 TABLE KNIFE HOLLOW HANDLE  
 SERRATED  
 25 CM - 9 IN<sup>13/16</sup>



**104712**  
**CUILLÈRE DE TABLE**  
 TABLE/PASTA SPOON  
 21 CM - 8 IN<sup>3/4</sup>



**186291**  
**CUILLÈRE À SOUPE ANGLAISE**  
 BOUILLON SPOON, ROUND  
 17,4 CM - 8 IN<sup>7/8</sup>



**104752**  
**CUILLÈRE À DESSERT**  
 DESSERT/SOUP SPOON, OVAL  
 18,1 CM - 7 IN<sup>1/8</sup>



**104765**  
**FOURCHETTE À DESSERT**  
 DESSERT/SALAD FORK  
 18,1 CM - 7 IN<sup>1/8</sup>



**104779**  
**COUTEAU À DESSERT**  
**MANCHE ORFEVRE LAME UNIE**  
 DESSERT KNIFE HOLLOW HANDLE  
 21 CM - 8 IN<sup>1/4</sup>



**186294**  
**COUTEAU À BEURRE**  
**MANCHE ORFEVRE**  
 BUTTER KNIFE HOLLOW HANDLE  
 19,2 CM - 7 IN<sup>9/16</sup>



**104766**  
**CUILLÈRE À CAFÉ**  
 COFFEE/TEA SPOON  
 14,4 CM - 5 IN<sup>11/16</sup>



**104707**  
**FOURCHETTE À POISSON**  
 FISH FORK  
 17,9 CM - 7 IN<sup>1/16</sup>



**104727**  
**COUTEAU À POISSON**  
 FISH KNIFE  
 20 CM - 7 IN<sup>7/8</sup>

EGALEMENT DISPONIBLE EN MÉTAL ARGENTÉ  
 ALSO AVAILABLE IN SILVERPLATED FINISH



Possibilité de personnalisation  
 Bespoke options available

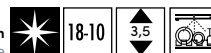

# CONTOUR

---

Finedining

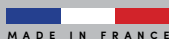

MADE IN FRANCE





**126077**  
**FOURCHETTE DE TABLE**  
TABLE FORK  
20,8 CM - 8 IN<sup>3/16</sup>



**126099**  
**FOURCHETTE À POISSON**  
FISH FORK  
17,7 CM - 6 IN<sup>5/16</sup>



**190643**  
**COUTEAU DE TABLE**  
**MONOBLOC LOURD**  
**LAME SCIE**  
TABLE KNIFE SOLID HANDLE SERRATED  
24,6 CM - 9 IN<sup>11/16</sup>



**126102**  
**COUTEAU À POISSON**  
FISH KNIFE  
19,9 CM - 7 IN<sup>13/16</sup>



**130140**  
**COUTEAU DE TABLE**  
**MANCHE ORFÈVRE DROIT LAME SCIE**  
TABLE KNIFE HOLLOW HANDLE SERRATED  
24,6 CM - 9 IN<sup>11/16</sup>



**126080**  
**CUILLÈRE À CAFÉ**  
COFFEE/TEA SPOON  
14 CM - 5 IN<sup>11/2</sup>



**127654**  
**COUTEAU À STEAK**  
**MANCHE ORFÈVRE DROIT LAME SCIE**  
STEAK KNIFE HOLLOW HANDLE SERRATED  
23,9 CM - 9 IN<sup>7/16</sup>



**126105**  
**CUILLÈRE À MOKA**  
DEMI TASSE SPOON  
11 CM - 4 IN<sup>5/16</sup>



**126074**  
**CUILLÈRE DE TABLE**  
TABLE/PASTA SPOON  
20,8 CM - 8 IN<sup>3/16</sup>



**126108**  
**FOURCHETTE À GÂTEAUX/**  
**COCKTAIL**  
PASTRY/COCKTAIL FORK  
13,8 CM - 5 IN<sup>7/16</sup>



**126090**  
**CUILLÈRE À DESSERT**  
DESSERT/SOUP SPOON, OVAL  
18 CM - 7 IN<sup>1/16</sup>



**190418**  
**FOURCHETTE À HUÎTRES**  
OYSTER FORK  
13 CM - 5 IN<sup>1/8</sup>



**126093**  
**FOURCHETTE À DESSERT**  
DESSERT/SALAD FORK  
17,8 CM - 7 IN

**SUGGESTION PIÈCES DE SERVICE**  
SUGGESTED SERVING PIECES  
VERLAINE



**190644**  
**COUTEAU À DESSERT**  
**MONOBLOC LOURD LAME UNIE**  
DESSERT KNIFE HEAVY SOLID HANDLE  
20,5 CM - 8 IN<sup>1/16</sup>



**002185**  
**FOURCHETTE**  
**DE SERVICE**  
SERVING FORK  
24,8 CM - 9 IN<sup>3/4</sup>



**126096**  
**COUTEAU À DESSERT**  
**MANCHE ORFÈVRE LAME UNIE**  
DESSERT KNIFE HOLLOW HANDLE  
20,5 CM - 8 IN<sup>1/16</sup>



**002186**  
**CUILLÈRE**  
**DE SERVICE**  
SERVING SPOON  
25 CM - 9 IN<sup>13/16</sup>



**190417**  
**COUTEAU À BEURRE**  
**MONOBLOC LOURD LAME UNIE**  
BUTTER KNIFE HEAVY SOLID HANDLE  
18,7 CM - 7 IN<sup>3/8</sup>



**040646**  
**SERVICE**  
**À SALADE**  
SALADE SERVING SET  
25,8 CM - 10 IN<sup>3/16</sup>



**129344**  
**COUTEAU À BEURRE**  
**MANCHE ORFÈVRE**  
**LAME UNIE**  
BUTTER KNIFE HOLLOW  
HANDLE  
18,7 CM - 7 IN<sup>3/8</sup>



**083340**  
**PELLE À TARTE**  
**MONOBLOC**  
PASTRY SERVER  
SOLID HANDLE  
24,9 CM - 9 IN<sup>13/16</sup>



**097717**  
**LOUCHE**  
SOUP LADLE  
29,8 CM - 11 IN<sup>3/4</sup>



**002179**  
**LOUCHE À SAUCE**  
SAUCE LADLE  
15,7 CM - 6 IN<sup>3/16</sup>

ÉGALEMENT DISPONIBLE EN MÉTAL ARGENTÉ  
ALSO AVAILABLE IN SILVERPLATED FINISH



Possibilité de personnalisation  
Bespoke options available

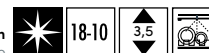

# FLORENCIA

---

Finedining





**105021**  
**FOURCHETTE DE TABLE**  
TABLE FORK  
20,9 CM - 8 IN<sup>3/16</sup>



**190415**  
**COUTEAU DE TABLE**  
**MONOBLOC LOURD LAME SCIE**  
TABLE KNIFE HEAVY SOLID HANDLE SERRATED  
24,8 CM - 9 IN<sup>3/4</sup>



**105006**  
**COUTEAU DE TABLE**  
**MANCHE ORFÈVRE LAME SCIE**  
TABLE KNIFE HOLLOW HANDLE SERRATED  
24,7 CM - 9 IN<sup>3/4</sup>



**122746**  
**COUTEAU À STEAK**  
**MANCHE ORFÈVRE LAME SCIE**  
STEAK KNIFE HOLLOW HANDLE SERRATED  
23,8 CM - 9 IN<sup>3/8</sup>



**104988**  
**CUILLÈRE DE TABLE**  
TABLE/PASTA SPOON  
21,1 CM - 8 IN<sup>5/16</sup>



**104975**  
**CUILLÈRE À SOUPE ANGLAISE**  
BOUILLON SPOON, ROUND  
17,4 CM - 6 IN<sup>7/8</sup>



**104985**  
**CUILLÈRE À DESSERT**  
DESSERT/SOUP SPOON, OVAL  
18 CM - 7 IN<sup>1/16</sup>



**105013**  
**FOURCHETTE À DESSERT**  
DESSERT/SALAD FORK  
17,9 CM - 7 IN<sup>1/16</sup>



**190416**  
**COUTEAU À DESSERT**  
**MONOBLOC LOURD LAME UNIE**  
DESSERT KNIFE HEAVY SOLID HANDLE  
21,3 CM - 8 IN<sup>3/8</sup>



**104989**  
**COUTEAU À DESSERT**  
**MANCHE ORFÈVRE LAME UNIE**  
DESSERT KNIFE HOLLOW HANDLE  
20,6 CM - 8 IN<sup>1/8</sup>



**190414**  
**COUTEAU À BEURRE**  
**MONOBLOC LOURD**  
**LAME UNIE**  
BUTTER KNIFE HEAVY SOLID HANDLE  
19,7 CM - 7 IN<sup>3/4</sup>



**016394**  
**COUTEAU À BEURRE**  
**MANCHE ORFÈVRE LAME UNIE**  
BUTTER KNIFE HOLLOW HANDLE  
18,9 CM - 7 IN<sup>7/16</sup>



**104994**  
**FOURCHETTE À POISSON**  
FISH FORK  
17,9 CM - 7 IN<sup>1/16</sup>



**104995**  
**COUTEAU À POISSON**  
FISH KNIFE  
20 CM - 7 IN<sup>7/8</sup>



**104986**  
**CUILLÈRE À CAFÉ**  
COFFEE/TEA SPOON  
14,1 CM - 5 IN<sup>9/16</sup>



**104993**  
**CUILLÈRE À MOKA**  
DEMI TASSE SPOON  
11,2 CM - 4 IN<sup>7/16</sup>



**105012**  
**FOURCHETTE À GÂTEAUX/**  
**COCKTAIL**  
PASTRY/COCKTAIL FORK  
13,9 CM - 5 IN<sup>1/2</sup>

EGALEMENT DISPONIBLE EN MÉTAL ARGENTÉ  
ALSO AVAILABLE IN SILVERPLATED FINISH



Possibilité de personnalisation  
Bespoke options available





# LUTÈCE

Finedining



MADE IN FRANCE





**182968**  
**FOURCHETTE DE TABLE**  
TABLE FORK  
20,8 CM - 8 IN<sup>3/16</sup>



**182972**  
**FOURCHETTE À POISSON**  
FISH FORK  
17,7 CM - 6 IN<sup>15/16</sup>



**182970**  
**COUPEAU DE TABLE**  
**MANCHE ORFÈVRE LAME SCIE**  
TABLE KNIFE HOLLOW HANDLE SERRATED  
24,6 CM - 9 IN<sup>11/16</sup>



**182973**  
**COUPEAU À POISSON**  
FISH KNIFE  
19,9 CM - 7 IN<sup>13/16</sup>



**186278**  
**COUPEAU À STEAK**  
**MANCHE ORFÈVRE LAME SCIE**  
STEAK KNIFE HOLLOW HANDLE SERRATED  
23,9 CM - 9 IN<sup>7/16</sup>



**182969**  
**CUILLÈRE À CAFÉ**  
COFFEE/TEA SPOON  
14 CM - 5 IN<sup>1/2</sup>



**182967**  
**CUILLÈRE DE TABLE**  
TABLE/PASTA SPOON  
20,8 CM - 8 IN<sup>3/16</sup>



**182976**  
**CUILLÈRE À MOKA**  
DEMI TASSE SPOON  
11 CM - 4 IN<sup>5/16</sup>



**186276**  
**CUILLÈRE À SOUPE ANGLAISE**  
BOUILLON SPOON, ROUND  
17,4 CM - 6 IN<sup>7/8</sup>



**186274**  
**FOURCHETTE À GÂTEAUX/**  
**COCKTAIL**  
PASTRY/COCKTAIL FORK  
13,8 CM - 5 IN<sup>7/16</sup>



**182974**  
**CUILLÈRE À DESSERT**  
DESSERT/SOUP SPOON, OVAL  
18 CM - 7 IN<sup>1/16</sup>



**190681**  
**FOURCHETTE À HUITRES**  
OYSTER FORK  
13 CM - 5 IN<sup>1/8</sup>



**182975**  
**FOURCHETTE À DESSERT**  
DESSERT/SALAD FORK  
17,8 CM - 7 IN



**182971**  
**COUPEAU À DESSERT**  
**MANCHE ORFÈVRE LAME UNIE**  
DESSERT KNIFE HOLLOW HANDLE  
20,5 CM - 8 IN<sup>1/16</sup>

**SUGGESTION PIÈCES DE SERVICE**  
SUGGESTED SERVING PIECES  
VERLAINE



**186279**  
**COUPEAU À BEURRE**  
**MANCHE ORFÈVRE LAME UNIE**  
BUTTER KNIFE HOLLOW HANDLE  
18,7 CM - 7 IN<sup>3/8</sup>



**002185**  
**FOURCHETTE**  
**DE SERVICE**  
SERVING FORK  
24,8 CM - 9 IN<sup>3/4</sup>



**002186**  
**CUILLÈRE**  
**DE SERVICE**  
SERVING SPOON  
25 CM - 9 IN<sup>13/16</sup>



**040646**  
**SERVICE**  
**À SALADE**  
SALADE SERVING SET  
25,8 CM - 10 IN<sup>3/16</sup>



**083340**  
**PELLE À TARTE**  
**MONOBLOC**  
PASTRY SERVER  
SOLID HANDLE  
24,9 CM - 9 IN<sup>13/16</sup>



**097717**  
**LOUCHE**  
SOUP LADLE  
29,8 CM - 11 IN<sup>3/4</sup>



**002179**  
**LOUCHE À SAUCE**  
SAUCE LADLE  
15,7 CM - 6 IN<sup>3/16</sup>

ÉGALEMENT DISPONIBLE EN MÉTAL ARGENTÉ  
ALSO AVAILABLE IN SILVERPLATED FINISH



Possibilité de personnalisation  
Bespoke options available

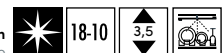

MARQUISE

Finedining

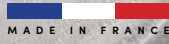

MADE IN FRANCE





**141089**  
**FOURCHETTE DE TABLE**  
TABLE FORK  
20,3 CM - 8 IN



**103550**  
**CUILLÈRE À CAFÉ**  
COFFEE/TEA SPOON  
13,5 CM - 5 IN<sup>5/16</sup>



**113017**  
**COUTEAU DE TABLE**  
**MONOBLOC LAME SCIE**  
TABLE KNIFE SOLID HANDLE  
SERRATED  
24,4 CM - 9 IN<sup>5/8</sup>



**109465**  
**CUILLÈRE À MOKA**  
DEMI TASSE SPOON  
11 CM - 4 IN<sup>5/16</sup>



**160427**  
**COUTEAU À STEAK**  
**MONOBLOC LAME SCIE**  
STEAK KNIFE SOLID HANDLE  
SERRATED  
23,2 CM - 9 IN<sup>1/8</sup>

**SUGGESTION PIÈCES DE SERVICE**  
SUGGESTED SERVING PIECES  
**BLOIS**



**124259**  
**CUILLÈRE À SODA**  
ICED TEA SPOON  
18,2 CM - 7 IN<sup>3/16</sup>



**141086**  
**CUILLÈRE DE TABLE**  
TABLE/PASTA SPOON  
20,4 CM - 8 IN<sup>1/16</sup>



**104480**  
**FOURCHETTE À GÂTEAUX/**  
**COCKTAIL**  
PASTRY/COCKTAIL FORK  
13,8 CM - 5 IN<sup>7/16</sup>



**104448**  
**CUILLÈRE À SOUPE ANGLAISE**  
**BLOIS**  
BOUILLON SPOON, ROUND  
17,2 CM - 6 IN<sup>3/4</sup>



**104463**  
**FOURCHETTE À HUÎTRES**  
OYSTER FORK  
13 CM - 5 IN<sup>1/8</sup>



**108236**  
**CUILLÈRE À DESSERT**  
DESSERT/SOUP SPOON, OVAL  
17,9 CM - 7 IN<sup>17/16</sup>



**195757**  
**FOURCHETTE DE SERVICE**  
SERVING FORK  
24,8 CM - 9 IN<sup>3/4</sup>



**108238**  
**FOURCHETTE À DESSERT**  
DESSERT/SALAD FORK  
17,8 CM - 7 IN



**195755**  
**CUILLÈRE DE SERVICE**  
SERVING SPOON  
25 CM - 9 IN<sup>13/16</sup>



**113019**  
**COUTEAU À DESSERT**  
**MONOBLOC LAME UNIE**  
DESSERT KNIFE SOLID HANDLE  
21 CM - 8 IN<sup>1/4</sup>



**195750**  
**SERVICE À SALADE**  
SALAD SERVING SET  
25,7 CM - 10 IN<sup>1/8</sup>



**189971**  
**COUTEAU À BEURRE**  
**MONOBLOC LAME UNIE**  
**GOUTTE**  
BUTTER KNIFE SOLID HANDLE  
18,8 CM - 7 IN<sup>3/8</sup>



**195753**  
**PELLE À TARTE MONOBLOC**  
PASTRY SERVER SOLID HANDLE  
24,9 CM - 9 IN<sup>13/16</sup>



**104507**  
**FOURCHETTE POISSON**  
**BLOIS**  
FISH FORK  
17,7 CM - 6 IN<sup>15/16</sup>



**195762**  
**LOUCHE**  
SOUP LADLE  
29,8 CM - 11 IN<sup>3/4</sup>



**104508**  
**COUTEAU POISSON**  
**BLOIS**  
FISH KNIFE  
19,9 CM - 7 IN<sup>13/16</sup>



**195759**  
**LOUCHE À SAUCE**  
SAUCE LADLE  
15,7 CM - 6 IN<sup>3/16</sup>

EGALEMENT DISPONIBLE EN MÉTAL ARGENTÉ  
ALSO AVAILABLE IN SILVERPLATED FINISH



Possibilité de personnalisation  
Bespoke options available

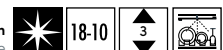

MIKADO

Alldaydining





**230285**  
**FOURCHETTE DE TABLE**  
TABLE FORK  
20,3 CM - 8 IN



**230287**  
**COUTEAU DE TABLE**  
**MONOBLOC LAME SCIE**  
TABLE KNIFE SOLID HANDLE SERRATED  
24,4 CM - 9 IN<sup>5/8</sup>



**230293**  
**COUTEAU À STEAK**  
**MONOBLOC LAME SCIE**  
STEAK KNIFE SOLID HANDLE SERRATED  
23,2 CM - 9 IN<sup>1/8</sup>



**230286**  
**CUILLÈRE DE TABLE**  
TABLE/PASTA SPOON  
20,4 CM - 8 IN<sup>1/16</sup>



**230291**  
**CUILLÈRE À DESSERT**  
DESSERT/SOUP SPOON, OVAL  
17,9 CM - 7 IN<sup>1/16</sup>



**230290**  
**FOURCHETTE À DESSERT**  
DESSERT/SALAD FORK  
17,8 CM - 7 IN



**230292**  
**COUTEAU À DESSERT**  
**MONOBLOC LOURD LAME UNIE**  
DESSERT KNIFE HEAVY SOLID HANDLE  
21 CM - 8 IN<sup>1/4</sup>



**230288**  
**CUILLÈRE À CAFÉ**  
COFFEE/TEA SPOON  
13,5 CM - 5 IN<sup>5/16</sup>



**230289**  
**CUILLÈRE À MOKA**  
DEMI TASSE SPOON  
11 CM - 4 IN<sup>5/16</sup>

# MIKADO VINTAGE

---

Alldaydining





**127442**  
**FOURCHETTE DE TABLE**  
TABLE FORK  
20,8 CM - 8 IN<sup>3/16</sup>



**226578**  
**COUTEAU DE TABLE**  
**MONOBLOC LOURD LAME SCIE**  
TABLE KNIFE HEAVY SOLID HANDLE SERRATED  
24,4 CM - 9 IN<sup>5/8</sup>



**139158**  
**COUTEAU DE TABLE**  
**MANCHE ORFÈVRE LAME SCIE**  
TABLE KNIFE HOLLOW HANDLE SERRATED  
24,6 CM - 9 IN<sup>1/16</sup>



**128841**  
**COUTEAU À STEAK**  
**MANCHE ORFÈVRE LAME SCIE**  
STEAK KNIFE HOLLOW HANDLE SERRATED  
23,9 CM - 9 IN<sup>7/16</sup>



**127439**  
**CUILLÈRE DE TABLE**  
TABLE/PASTA SPOON  
20,8 CM - 8 IN<sup>3/16</sup>



**127464**  
**CUILLÈRE À DESSERT**  
DESSERT/SOUP SPOON, OVAL  
18 CM - 7 IN<sup>1/16</sup>



**127467**  
**FOURCHETTE À DESSERT**  
DESSERT/SALAD FORK  
17,8 CM - 7 IN



**226579**  
**COUTEAU À DESSERT**  
**MONOBLOC LOURD LAME UNIE**  
DESSERT KNIFE HEAVY SOLID HANDLE  
21,1 CM - 8 IN<sup>5/16</sup>



**127470**  
**COUTEAU À DESSERT**  
**MANCHE ORFÈVRE LAME UNIE**  
DESSERT KNIFE HOLLOW HANDLE  
20,5 CM - 8 IN<sup>1/16</sup>



**226580**  
**COUTEAU À BEURRE**  
**MONOBLOC LOURD LAME UNIE**  
BUTTER KNIFE HEAVY SOLID HANDLE  
19 CM - 7 IN<sup>1/2</sup>



**122769**  
**COUTEAU À BEURRE**  
**MANCHE ORFÈVRE LAME UNIE**  
BUTTER KNIFE HOLLOW HANDLE  
18,7 CM - 7 IN<sup>3/8</sup>



**127473**  
**FOURCHETTE À POISSON**  
FISH FORK  
17,7 CM - 6 IN<sup>15/16</sup>



**127477**  
**COUTEAU À POISSON**  
FISH KNIFE  
19,9 CM - 7 IN<sup>13/16</sup>



**130542**  
**CUILLÈRE À SAUCE GOURMET**  
GOURMET/SAUCE SPOON  
17,9 CM - 7 IN<sup>1/16</sup>



**127455**  
**CUILLÈRE À CAFÉ**  
COFFEE/TEA SPOON  
14 CM - 5 IN<sup>1/2</sup>



**127479**  
**CUILLÈRE À MOKA**  
DEMI TASSE SPOON  
11 CM - 4 IN<sup>5/16</sup>



**127482**  
**FOURCHETTE À GÂTEAUX/**  
**COCKTAIL**  
PASTRY/COCKTAIL FORK  
13,8 CM - 5 IN<sup>7/16</sup>



**130266**  
**FOURCHETTE À HUÎTRES**  
OYSTER FORK  
13 CM - 5 IN<sup>1/8</sup>

**SUGGESTION PIÈCES DE SERVICE**  
SUGGESTED SERVING PIECES  
**VERLAINE**



**002185**  
**FOURCHETTE**  
**DE SERVICE**  
SERVING FORK  
24,8 CM - 9 IN<sup>3/4</sup>



**002186**  
**CUILLÈRE**  
**DE SERVICE**  
SERVING SPOON  
25 CM - 9 IN<sup>13/16</sup>



**040646**  
**SERVICE**  
**À SALADE**  
SALADE SERVING SET  
25,8 CM - 10 IN<sup>3/16</sup>



**083340**  
**PELLE À TARTE**  
**MONOBLOC**  
PASTRY SERVER  
SOLID HANDLE  
24,9 CM - 9 IN<sup>13/16</sup>



**097717**  
**LOUCHE**  
SOUP LADLE  
29,8 CM - 11 IN<sup>3/4</sup>



**002179**  
**LOUCHE À SAUCE**  
SAUCE LADLE  
15,7 CM - 6 IN<sup>3/16</sup>

ÉGALEMENT DISPONIBLE EN MÉTAL ARGENTÉ  
ALSO AVAILABLE IN SILVERPLATED FINISH



Possibilité de personnalisation  
Bespoke options available

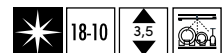



MILADY

Finedining

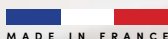

MADE IN FRANCE





**105278  
FOURCHETTE DE TABLE**  
TABLE FORK  
20,8 CM - 8 IN<sup>3/16</sup>



**105274  
COUTEAU DE TABLE  
MANCHE ORFÈVRE LAME SCIE**  
TABLE KNIFE HOLLOW HANDLE SERRATED  
24,6 CM - 9 IN<sup>1/16</sup>



**105310  
CUILLÈRE DE TABLE**  
TABLE/PASTA SPOON  
20,8 CM - 8 IN<sup>3/16</sup>



**105294  
CUILLÈRE À DESSERT**  
DESSERT/SOUP SPOON, OVAL  
CUCHARA DE POSTRE  
18 CM - 7 IN<sup>1/16</sup>



**105290  
FOURCHETTE À DESSERT**  
DESSERT/SALAD FORK  
17,8 CM - 7 IN



**105305  
COUTEAU À DESSERT  
MANCHE ORFÈVRE LAME UNIE**  
DESSERT KNIFE HOLLOW HANDLE  
20,5 CM - 8 IN<sup>1/16</sup>



**105303  
CUILLÈRE À CAFÉ**  
COFFEE/TEA SPOON  
14 CM - 5 IN<sup>1/2</sup>



**105293  
CUILLÈRE À MOKA**  
DEMI TASSE SPOON  
11 CM - 4 IN<sup>5/16</sup>

**SUGGESTION PIÈCES DE SERVICE**  
SUGGESTED SERVING PIECES  
**VERLAINE**



**002185  
FOURCHETTE DE SERVICE**  
SERVING FORK  
24,8 CM - 9 IN<sup>3/4</sup>



**002186  
CUILLÈRE DE SERVICE**  
SERVING SPOON  
25 CM - 9 IN<sup>3/16</sup>



**040646  
SERVICE À SALADE**  
SALADE SERVING SET  
25,8 CM - 10 IN<sup>3/16</sup>



**083340  
PELLE À TARTE MONOBLOC**  
PASTRY SERVER  
SOLID HANDLE  
24,9 CM - 9 IN<sup>13/16</sup>



**097717  
LOUCHE**  
SOUP LADLE  
29,8 CM - 11 IN<sup>3/4</sup>



**002179  
LOUCHE À SAUCE**  
SAUCE LADLE  
15,7 CM - 6 IN<sup>3/16</sup>

ÉGALEMENT DISPONIBLE EN MÉTAL ARGENTÉ  
ALSO AVAILABLE IN SILVERPLATED FINISH



Possibilité de personnalisation  
Bespoke options available



# NEUILLY

Finedining



MADE IN FRANCE





**232963**  
**FOURCHETTE DE TABLE**  
 TABLE FORK  
 20,3 CM - 8 IN



**232966**  
**COUTEAU DE TABLE**  
**MONOBLOC LAME SCIE**  
 TABLE KNIFE SOLID HANDLE SERRATED  
 24 CM - 9 IN<sup>7/16</sup>



**232964**  
**CUILLÈRE DE TABLE**  
 TABLE/PASTA SPOON  
 20,3 CM - 8 IN



**234654**  
**CUILLÈRE À SOUPE ANGLAISE**  
 BOUILLON SPOON  
 17,6 CM - 6 IN<sup>15/16</sup>



**234659**  
**CUILLÈRE À DESSERT**  
 DESSERT/SOUP SPOON, OVAL  
 18,2 CM - 7 IN<sup>3/16</sup>



**234655**  
**CUILLÈRE GOURMET**  
 GOURMET SPOON  
 18,2 CM - 7 IN<sup>3/16</sup>



**234656**  
**FOURCHETTE À DESSERT/POISSON**  
 DESSERT/SALAD/FISH FORK  
 18,3 CM - 7 IN<sup>3/16</sup>



**239036**  
**COUTEAU À POISSON/SPATULE GOURMET**  
**MONOBLOC LAME UNIE**  
 FISH KNIFE/GOURMET SPATULA  
 21,5 CM - 8 IN<sup>7/16</sup>



**234657**  
**COUTEAU À DESSERT**  
**MONOBLOC LAME UNIE**  
 DESSERT KNIFE SOLID HANDLE  
 21,5 CM - 8 IN<sup>7/16</sup>



**234658**  
**COUTEAU À BEURRE**  
**MONOBLOC LAME UNIE**  
 BUTTER KNIFE SOLID HANDLE  
 18,5 CM - 7 IN<sup>5/16</sup>



**232965**  
**CUILLÈRE À CAFÉ**  
 COFFEE/TEA SPOON  
 14 CM - 5 IN<sup>1/2</sup>



**234660**  
**CUILLÈRE À MOKA**  
 DEMI TASSE SPOON  
 11,1 CM - 4 IN<sup>3/8</sup>



**234661**  
**FOURCHETTE À GÂTEAUX/COCKTAIL**  
 PASTRY/COCKTAIL FORK  
 14 CM - 5 IN<sup>1/2</sup>

EGALEMENT DISPONIBLE EN MÉTAL ARGENTÉ  
 ALSO AVAILABLE IN SILVERPLATED FINISH



Possibilité de personnalisation  
 Bespoke options available

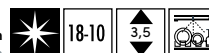

# NORMANDY

Finedining





**204524**  
**FOURCHETTE DE TABLE**  
 TABLE FORK  
 20,2 CM - 7 IN<sup>5/16</sup>



**246567**  
**COUTEAU DE TABLE**  
**MONOBLOC LAME SCIE**  
 TABLE KNIFE SOLID HANDLE SERRATED  
 24,4 CM - 9 IN<sup>5/8</sup>



**204523**  
**CUILLÈRE DE TABLE**  
 TABLE/PASTA SPOON  
 20,2 CM - 7 IN<sup>5/16</sup>



**209268**  
**CUILLÈRE À DESSERT**  
 DESSERT/SOUP SPOON, OVAL  
 17,9 CM - 7 IN<sup>1/16</sup>



**209267**  
**FOURCHETTE À DESSERT**  
 DESSERT FORK  
 17,8 CM - 7 IN



**246568**  
**COUTEAU À DESSERT**  
**MONOBLOC LAME UNIE**  
 DESSERT KNIFE SOLID HANDLE  
 21 CM - 8 IN<sup>1/4</sup>



**204525**  
**CUILLÈRE À CAFÉ**  
 COFFEE/TEA SPOON  
 13,5 CM - 5 IN<sup>5/16</sup>

EGALEMENT DISPONIBLE EN MÉTAL ARGENTÉ  
 ALSO AVAILABLE IN SILVERPLATED FINISH



Possibilité de personnalisation  
 Bespoke options available



# SWELL

---

Alldaydining



**NEW**





**105831**  
**FOURCHETTE DE TABLE**  
TABLE FORK  
20,8 CM - 8 IN<sup>3/16</sup>



**182460**  
**COUTEAU DE TABLE**  
**MONOBLOC LOURD LAME SCIE**  
TABLE KNIFE HEAVY SOLID HANDLE  
SERRATED  
24,6 CM - 9 IN<sup>11/16</sup>



**105886**  
**COUTEAU DE TABLE**  
**MANCHE ORFÈVRE LAME UNIE**  
TABLE KNIFE HOLLOW HANDLE  
24,6 CM - 9 IN<sup>11/16</sup>



**105860**  
**COUTEAU DE TABLE**  
**MANCHE ORFÈVRE LAME SCIE**  
TABLE KNIFE HOLLOW HANDLE SERRATED  
24,6 CM - 9 IN<sup>11/16</sup>



**105801**  
**COUTEAU À STEAK**  
**MANCHE ORFÈVRE LAME SCIE**  
STEAK KNIFE HOLLOW HANDLE SERRATED  
23,9 CM - 9 IN<sup>7/16</sup>



**105798**  
**CUILLÈRE DE TABLE**  
TABLE/PASTA SPOON  
20,8 CM - 8 IN<sup>3/16</sup>



**105908**  
**CUILLÈRE À SOUPE ANGLAISE**  
BOUILLON SPOON, ROUND  
17,2 CM - 6 IN<sup>3/4</sup>



**105861**  
**CUILLÈRE À DESSERT**  
DESSERT/SOUP SPOON, OVAL  
18 CM - 7 IN<sup>1/16</sup>



**105885**  
**FOURCHETTE À DESSERT**  
DESSERT/SALAD FORK  
17,8 CM - 7 IN



**182463**  
**COUTEAU À DESSERT**  
**MONOBLOC LOURD LAME UNIE**  
DESSERT KNIFE HEAVY SOLID HANDLE  
20,5 CM - 8 IN<sup>1/16</sup>



**105832**  
**COUTEAU À DESSERT**  
**MANCHE ORFÈVRE**  
**LAME UNIE**  
DESSERT KNIFE HOLLOW HANDLE  
20,5 CM - 8 IN<sup>1/16</sup>



**190420**  
**COUTEAU À BEURRE**  
**MONOBLOC LOURD**  
**LAME UNIE**  
BUTTER KNIFE HEAVY SOLID HANDLE  
19 CM - 7 IN<sup>1/2</sup>



**003332**  
**COUTEAU À BEURRE**  
**MANCHE ORFÈVRE**  
**LAME UNIE**  
BUTTER KNIFE HOLLOW HANDLE  
18,7 CM - 7 IN<sup>3/8</sup>



**105888**  
**FOURCHETTE À POISSON**  
FISH FORK  
17,8 CM - 7 IN



**105797**  
**COUTEAU À POISSON**  
FISH KNIFE  
19,7 CM - 7 IN<sup>3/4</sup>



**105910**  
**CUILLÈRE À SAUCE GOURMET**  
GOURMET/SAUCE SPOON  
17,9 CM - 7 IN<sup>1/16</sup>



**105833**  
**CUILLÈRE À CAFÉ**  
COFFEE/TEA SPOON  
14 CM - 5 IN<sup>1/2</sup>



**109471**  
**CUILLÈRE À MOKA**  
**CONFIDENCE**  
DEMI TASSE SPOON  
11 CM - 4 IN<sup>5/16</sup>



**105800**  
**CUILLÈRE À SODA**  
ICED TEA SPOON  
18,2 CM - 7 IN<sup>3/16</sup>



**105795**  
**FOURCHETTE À GÂTEAUX/**  
**COCKTAIL**  
PASTRY/COCKTAIL FORK  
13,8 CM - 5 IN<sup>7/16</sup>



**105907**  
**FOURCHETTE À HUITRES**  
OYSTER FORK  
12,9 CM - 5 IN<sup>1/16</sup>



**132782**  
**FOURCHETTE À ESCARGOTS**  
**CONFIDENCE**  
SNAIL FORK  
13,5 CM - 5 IN<sup>5/16</sup>



**003390**  
**COUTEAU À FROMAGES**  
**MANCHE ORFÈVRE LAME UNIE**  
CHEESE KNIFE HOLLOW HANDLE  
19,3 CM - 7 IN<sup>5/8</sup>



**002185**  
**FOURCHETTE DE SERVICE**  
SERVING FORK  
24,8 CM - 9 IN<sup>3/4</sup>



**002186**  
**CUILLÈRE DE SERVICE**  
SERVING SPOON  
25 CM - 9 IN<sup>13/16</sup>



**040646**  
**SERVICE À SALADE**  
SALADE SERVING SET  
25,8 CM - 10 IN<sup>3/16</sup>



**083340**  
**PELLE À TARTE MONOBLOC**  
PASTRY SERVER SOLID HANDLE  
24,9 CM - 9 IN<sup>13/16</sup>



**097717**  
**LOUCHE**  
SOUP LADLE  
29,8 CM - 11 IN<sup>3/4</sup>



**002179**  
**LOUCHE À SAUCE**  
SAUCE LADLE  
15,7 CM - 6 IN<sup>3/16</sup>

EGALEMENT DISPONIBLE EN MÉTAL ARGENTÉ  
ALSO AVAILABLE IN SILVERPLATED FINISH



Possibilité de personnalisation  
Bespoke options available

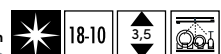



# VERLAINE

Finedining

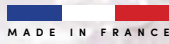

MADE IN FRANCE





**105804**  
**FOURCHETTE DE TABLE**  
TABLE FORK  
21 CM - 8 IN<sup>1/4</sup>



**105892**  
**COUTEAU DE TABLE**  
**MONOBLOC LAME SCIE**  
TABLE KNIFE SOLID HANDLE  
SERRATED  
25 CM - 9 IN<sup>13/16</sup>



**160424**  
**COUTEAU À STEAK**  
**MONOBLOC LAME SCIE**  
STEAK KNIFE SOLID HANDLE SERRATED  
23,2 CM - 9 IN<sup>1/8</sup>



**105911**  
**CUILLÈRE DE TABLE**  
TABLE/PASTA SPOON  
21 CM - 8 IN<sup>1/4</sup>



**105863**  
**CUILLÈRE À DESSERT**  
DESSERT/SOUP SPOON, OVAL  
18 CM - 7 IN<sup>1/16</sup>



**105890**  
**FOURCHETTE À DESSERT**  
DESSERT/SALAD FORK  
18 CM - 7 IN<sup>1/16</sup>



**210626**  
**COUTEAU À DESSERT**  
**MONOBLOC LAME SCIE**  
DESSERT KNIFE SOLID HANDLE SERRATED  
20,7 CM - 8 IN<sup>1/8</sup>



**105837**  
**FOURCHETTE À POISSON**  
FISH FORK  
18 CM - 7 IN<sup>1/16</sup>



**105912**  
**COUTEAU À POISSON**  
FISH KNIFE  
20 CM - 7 IN<sup>7/8</sup>



**105838**  
**CUILLÈRE À CAFÉ**  
COFFEE/TEA SPOON  
14,1 CM - 5 IN<sup>9/16</sup>



**105891**  
**CUILLÈRE À MOKA**  
DEMI TASSE SPOON  
11 CM - 4 IN<sup>5/16</sup>



**105805**  
**FOURCHETTE À GÂTEAUX/**  
**COCKTAIL**  
PASTRY/COCKTAIL FORK  
13,9 CM - 5 IN<sup>1/2</sup>



**105803**  
**FOURCHETTE À HÙITRES**  
OYSTER FORK  
13,2 CM - 5 IN<sup>3/16</sup>



**000490**  
**FOURCHETTE DE SERVICE**  
SERVING FORK  
24,6 CM - 9 IN<sup>11/16</sup>



**000491**  
**CUILLÈRE DE SERVICE**  
SERVING SPOON  
24,9 CM - 9 IN<sup>12/16</sup>

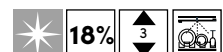

# VIEUX PARIS

Alldaydining





**LE COUVERT DESIGN**  
Design Flatware



**126355**  
**FOURCHETTE DE TABLE**  
TABLE FORK  
20,1 CM - 7 IN<sup>15/16</sup>



**126358**  
**CUILLÈRE À CAFÉ**  
COFFEE/TEA SPOON  
13,7 CM - 5 IN<sup>3/8</sup>



**210731**  
**COUTEAU DE TABLE**  
**MONOBLOC LAME SCIE**  
TABLE KNIFE SOLID HANDLE SERRATED  
23,5 CM - 9 IN<sup>1/4</sup>



**140852**  
**CUILLÈRE À MOKA**  
DEMI TASSE SPOON  
11 CM - 4 IN<sup>5/16</sup>



**126352**  
**CUILLÈRE DE TABLE**  
TABLE/PASTA SPOON  
20,3 CM - 8 IN



**189973**  
**CUILLÈRE À SODA**  
**GOUTTE**  
ICED TEA SPOON  
19 CM - 7 IN<sup>1/2</sup>



**140855**  
**CUILLÈRE À SOUPE ANGLAISE**  
BOUILLON SPOON, ROUND  
17,9 CM - 7 IN<sup>1/8</sup>



**126383**  
**FOURCHETTE À GÂTEAUX**  
**COCKTAIL**  
PASTRY/COCKTAIL FORK  
13,7 CM - 5 IN<sup>3/8</sup>



**126368**  
**CUILLÈRE À DESSERT**  
DESSERT/SOUP SPOON, OVAL  
17,8 CM - 7 IN



**189974**  
**FOURCHETTE À HÛÎTRES**  
**GOUTTE**  
OYSTER FORK  
14,1 CM - 5 IN<sup>11/16</sup>



**126371**  
**FOURCHETTE À DESSERT**  
DESSERT/SALAD FORK  
17,7 CM - 6 IN<sup>15/16</sup>



**231218**  
**FOURCHETTE DE SERVICE**  
**GOUTTE**  
SERVING FORK  
26,6 CM - 10 IN<sup>1/2</sup>



**210732**  
**COUTEAU À DESSERT**  
**MONOBLOC LAME UNIE**  
DESSERT KNIFE SOLID HANDLE  
20,7 CM - 8 IN<sup>1/8</sup>



**231219**  
**CUILLÈRE DE SERVICE**  
**GOUTTE**  
SERVING SPOON  
26,6 CM - 10 IN<sup>1/2</sup>



**189971**  
**COUTEAU À BEURRE**  
**MONOBLOC LAME UNIE**  
**GOUTTE**  
BUTTER KNIFE SOLID HANDLE  
18,8 CM - 7 IN<sup>3/8</sup>



**231221**  
**PELLE À TARTE MONOBLOC**  
**GOUTTE**  
PASTRY SERVER SOLID HANDLE  
25,2 CM - 9 IN<sup>15/16</sup>



**126377**  
**FOURCHETTE À POISSON**  
FISH FORK  
17,7 CM - 6 IN<sup>15/16</sup>



**231220**  
**LOUCHE**  
**GOUTTE**  
SOUP LADLE  
29 CM - 11 IN<sup>7/16</sup>



**181181**  
**COUTEAU À POISSON/**  
**GOURMET**  
GOURMET FISH KNIFE  
20,1 CM - 7 IN<sup>15/16</sup>

EGALEMENT DISPONIBLE EN MÉTAL ARGENTÉ  
ALSO AVAILABLE IN SILVERPLATED FINISH



Possibilité de personnalisation  
Bespoke options available



# AQUATIC

Finedining





**153998**  
**FOURCHETTE DE TABLE**  
TABLE FORK  
20,7 CM - 8 IN<sup>1/8</sup>



**154002**  
**COUTEAU DE TABLE MONOBLOC LAME SCIE**  
TABLE KNIFE SOLID HANDLE SERRATED  
23,5 CM - 9 IN<sup>1/4</sup>



**199761**  
**COUTEAU À STEAK**  
STEAK TABLE  
22,8 CM - 9 IN



**153996**  
**CUILLÈRE DE TABLE**  
TABLE/PASTA SPOON  
20,7 CM - 8 IN<sup>7/8</sup>



**190015**  
**CUILLÈRE À SOUPE ANGLAISE**  
BOUILLON SPOON, ROUND  
18,3 CM - 7 IN<sup>3/16</sup>



**154571**  
**CUILLÈRE À DESSERT**  
DESSERT/SOUP SPOON, OVAL  
18,6 CM - 7 IN<sup>5/16</sup>



**154574**  
**FOURCHETTE À DESSERT**  
DESSERT/SALAD FORK  
18,6 CM - 7 IN<sup>5/16</sup>



**154555**  
**COUTEAU À DESSERT MONOBLOC LAME SCIE**  
DESSERT KNIFE SOLID HANDLE SERRATED  
21,1 CM - 8 IN<sup>5/16</sup>



**154580**  
**COUTEAU À BEURRE MONOBLOC LAME UNIE**  
BUTTER KNIFE SOLID HANDLE  
19,4 CM - 7 IN<sup>5/8</sup>



**154558**  
**FOURCHETTE À POISSON**  
FISH FORK  
18,7 CM - 7 IN<sup>3/8</sup>



**154561**  
**COUTEAU À POISSON/ GOURMET**  
GOURMET FISH KNIFE  
21,1 CM - 8 IN<sup>5/16</sup>



**154001**  
**CUILLÈRE À CAFÉ**  
COFFEE/TEA SPOON  
14,1 CM - 5 IN<sup>3/16</sup>



**154577**  
**CUILLÈRE À MOKA**  
DEMI TASSE SPOON  
11,1 CM - 4 IN<sup>3/8</sup>



**190016**  
**CUILLÈRE À SODA**  
ICED TEA SPOON  
19 CM - 7 IN<sup>1/2</sup>



**154547**  
**FOURCHETTE À GÂTEAUX COCKTAIL**  
PASTRY/COCKTAIL FORK  
14 CM - 5 IN<sup>1/2</sup>



**154563**  
**FOURCHETTE DE SERVICE**  
SERVING FORK  
25,1 CM - 9 IN<sup>7/8</sup>



**154562**  
**CUILLÈRE DE SERVICE**  
SERVING SPOON  
25,5 CM - 10 IN<sup>1/16</sup>



**154566**  
**SERVICE À SALADE**  
SALAD SERVING SET  
24,3 CM - 9 IN<sup>3/16</sup>



**154552**  
**PELLE À TARTE MONOBLOC**  
PASTRY SERVER SOLID HANDLE  
25,3 CM - 9 IN<sup>15/16</sup>



**154550**  
**LOUCHE**  
SOUP LADLE  
29,7 CM - 11 IN<sup>11/16</sup>





# ASTRÉE CISELÉ

Alldaydining





**239410**  
**FOURCHETTE DE TABLE**  
 TABLE FORK  
 20,1 CM - 7 IN<sup>5/16</sup>



**239411**  
**COUTEAU DE TABLE**  
**MANCHE ORFÈVRE LAME UNIE**  
 HOLLOW HANDLE TABLE KNIFE  
 23,5 CM - 9 IN<sup>1/4</sup>



**239412**  
**CUILLÈRE DE TABLE**  
 TABLE/PASTA SPOON  
 20,3 CM - 8 IN



**239416**  
**CUILLÈRE À DESSERT**  
 DESSERT/SOUP SPOON, OVAL  
 17,8 CM - 7 IN



**239414**  
**FOURCHETTE À DESSERT**  
 DESSERT/SALAD FORK  
 17,7 CM - 6 IN<sup>5/16</sup>



**239415**  
**COUTEAU À DESSERT**  
**MANCHE ORFÈVRE LAME UNIE**  
 DESSERT KNIFE HOLLOW HANDLE  
 20,7 CM - 8 IN<sup>1/8</sup>



**239418**  
**FOURCHETTE À POISSON**  
 FISH FORK  
 17,7 CM - 6 IN<sup>5/16</sup>



**239419**  
**COUTEAU À POISSON/**  
**GOURMET**  
 GOURMET FISH KNIFE  
 20,3 CM - 8 IN



**239413**  
**CUILLÈRE À CAFÉ**  
 COFFEE/TEA SPOON  
 13,7 CM - 5 IN<sup>3/8</sup>



**239417**  
**CUILLÈRE À MOKA**  
 COFFEE/TEA SPOON  
 11 CM - 4 IN<sup>5/16</sup>

EGALEMENT DISPONIBLE EN MÉTAL ARGENTÉ  
 ALSO AVAILABLE IN SILVERPLATED FINISH

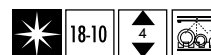

# COUTURE

Finedining





**236700**  
**FOURCHETTE DE TABLE**  
 TABLE FORK  
 21,5 CM - 8 IN<sup>7/16</sup>



**236702**  
**COUPEAU DE TABLE**  
**MONOBLOC LAME SCIE**  
 TABLE KNIFE SOLID HANDLE SERRATED  
 21,5 CM - 8 IN<sup>7/16</sup>



**111970**  
**COUPEAU DE TABLE**  
**MONOBLOC LAME SCIE**  
**OVATION**  
 TABLE KNIFE SOLID HANDLE SERRATED  
 23 CM - 9 IN<sup>1/16</sup>



**236701**  
**CUILLÈRE DE TABLE**  
 TABLE/PASTA SPOON  
 21,5 CM - 8 IN<sup>7/16</sup>



**236726**  
**CUILLÈRE À SOUPE ANGLAISE**  
 BOUILLON SPOON, ROUND  
 18,5 CM - 7 IN<sup>5/16</sup>



**236721**  
**CUILLÈRE À DESSERT**  
 DESSERT/SOUP SPOON, OVAL  
 19,1 CM - 7 IN<sup>1/2</sup>



**236719**  
**FOURCHETTE À DESSERT**  
 DESSERT/SALAD FORK  
 19,1 CM - 7 IN<sup>1/2</sup>



**236720**  
**COUPEAU À DESSERT**  
**MONOBLOC LAME UNIE**  
 DESSERT KNIFE SOLID HANDLE  
 19,2 CM - 7 IN<sup>9/16</sup>



**236727**  
**TARTINEUR**  
 BUTTER SPREADER  
 16,5 CM - 6 IN<sup>1/2</sup>



**181112**  
**TARTINEUR**  
**XY**  
 BUTTER SPREADER  
 16 CM - 6 IN<sup>5/16</sup>



**236703**  
**CUILLÈRE À CAFÉ**  
 COFFEE/TEA SPOON  
 15 CM - 5 IN<sup>7/8</sup>



**236722**  
**CUILLÈRE À MOKA**  
 DEMI TASSE SPOON  
 11 CM - 4 IN<sup>5/16</sup>



**236724**  
**FOURCHETTE DE SERVICE**  
 SERVING FORK  
 26 CM - 10 IN<sup>1/4</sup>



**236723**  
**CUILLÈRE DE SERVICE**  
 SERVING SPOON  
 26 CM - 10 IN<sup>1/4</sup>

EGALEMENT DISPONIBLE EN MÉTAL ARGENTÉ  
 ALSO AVAILABLE IN SILVERPLATED FINISH



Possibilité de personnalisation  
 Bespoke options available



# FUSE MIROIR

Alldaydining



## FUSE MARTELÉ HAMMERED



**236790**  
**FOURCHETTE DE TABLE**  
TABLE FORK  
21,5 CM - 8 IN<sup>7/16</sup>



**236791**  
**COUTEAU DE TABLE**  
**MONOBLOC LAME SCIE**  
TABLE KNIFE SOLID HANDLE SERRATED  
21,5 CM - 8 IN<sup>7/16</sup>



**236789**  
**CUILLÈRE DE TABLE**  
TABLE/PASTA SPOON  
21,5 CM - 8 IN<sup>7/16</sup>



**236802**  
**CUILLÈRE À SOUPE ANGLAISE**  
BOUILLON SPOON, ROUND  
18,5 CM - 7 IN<sup>5/16</sup>



**236796**  
**CUILLÈRE À DESSERT**  
DESSERT/SOUP SPOON, OVAL  
19,1 CM - 7 IN<sup>1/2</sup>



**236794**  
**FOURCHETTE À DESSERT**  
DESSERT/SALAD FORK  
19,1 CM - 7 IN<sup>1/2</sup>



**236795**  
**COUTEAU À DESSERT**  
**MONOBLOC LAME UNIE**  
DESSERT KNIFE SOLID HANDLE  
19,2 CM - 7 IN<sup>3/16</sup>



**236804**  
**TARTINEUR**  
BUTTER SPREADER  
16,5 CM - 6 IN<sup>1/2</sup>



**236798**  
**CUILLÈRE À CAFÉ**  
COFFEE/TEA SPOON  
15 CM - 5 IN<sup>7/8</sup>



**236797**  
**CUILLÈRE À MOKA**  
DEMI TASSE SPOON  
11 CM - 4 IN<sup>5/16</sup>



**236806**  
**PIC APÉRO/ESCARGOTS**  
COCKTAIL /SNAIL PICK  
15 CM - 5 IN<sup>7/8</sup>



**236805**  
**FOURCHETTE/GÂTEAUX**  
**ESCARGOTS/COCKTAIL**  
CAKE/COCKTAIL FORK  
15 CM - 5 IN<sup>7/8</sup>



**236800**  
**FOURCHETTE DE SERVICE**  
SERVING FORK  
26 CM - 10 IN<sup>1/4</sup>



**236799**  
**CUILLÈRE DE SERVICE**  
SERVING SPOON  
26 CM - 10 IN<sup>1/4</sup>

Possibilité de personnalisation  
Bespoke options available



# FUSE MARTELÉ

---

Alldaydining



**197507**  
**FOURCHETTE DE TABLE**  
TABLE FORK  
21,3 CM - 8 IN<sup>3/8</sup>



**197509**  
**COUTEAU DE TABLE**  
**MONOBLOC LAME SCIE**  
TABLE KNIFE SOLID HANDLE SERRATED  
23,2 CM - 9 IN<sup>3/8</sup>



**235481**  
**COUTEAU DE TABLE**  
**MONOBLOC LAME SCIE**  
TABLE KNIFE SOLID HANDLE SERRATED  
23,7 CM - 9 IN<sup>5/16</sup>



**197521**  
**COUTEAU À STEAK**  
**MONOBLOC LAME SCIE**  
STEAK KNIFE SOLID HANDLE SERRATED  
23,2 CM - 9 IN<sup>3/8</sup>



**197506**  
**CUILLÈRE DE TABLE**  
TABLE/PASTA SPOON  
21,6 CM - 8 IN<sup>1/2</sup>



**197518**  
**CUILLÈRE À SOUPE ANGLAISE**  
BOUILLON SPOON, ROUND  
18,5 CM - 7 IN<sup>5/16</sup>



**197512**  
**CUILLÈRE À DESSERT**  
DESSERT/SOUP SPOON, OVAL  
19,5 CM - 7 IN<sup>11/16</sup>



**197511**  
**FOURCHETTE À DESSERT**  
DESSERT/SALAD FORK  
19,2 CM - 7 IN<sup>9/16</sup>



**210629**  
**COUTEAU À DESSERT**  
**MONOBLOC LAME SCIE**  
DESSERT KNIFE SOLID HANDLE  
SERRATED  
20,9 CM - 8 IN<sup>3/16</sup>



**235482**  
**COUTEAU À DESSERT**  
**MONOBLOC LAME UNIE**  
DESSERT KNIFE SOLID HANDLE  
21,3 CM - 8 IN<sup>3/8</sup>



**197520**  
**COUTEAU À BEURRE**  
**MONOBLOC LAME UNIE**  
BUTTER KNIFE SOLID HANDLE  
19,3 CM - 7 IN<sup>5/8</sup>



**181112**  
**TARTINEUR**  
**XY**  
BUTTER SPREADER  
16 CM - 6 IN<sup>5/16</sup>



**197514**  
**FOURCHETTE À POISSON**  
FISH FORK  
19,2 CM - 7 IN<sup>9/16</sup>



**197515**  
**COUTEAU À POISSON/GOURMET**  
GOURMET FISH KNIFE  
21,3 CM - 8 IN<sup>3/8</sup>



**197508**  
**CUILLÈRE À CAFÉ**  
COFFEE/TEA SPOON  
14,3 CM - 5 IN<sup>5/8</sup>



**197510**  
**CUILLÈRE À MOKA**  
DEMI TASSE SPOON  
11,7 CM - 4 IN<sup>5/8</sup>



**190018**  
**CUILLÈRE À SODA**  
**DROIT**  
ICED TEA SPOON  
19 CM - 7 IN<sup>1/2</sup>



**197516**  
**FOURCHETTE À GÂTEAUX/COCKTAIL**  
PASTRY/COCKTAIL FORK  
13,9 CM - 5 IN<sup>1/2</sup>



**190424**  
**FOURCHETTE À HÙÎTRES**  
**DROIT**  
OYSTER FORK  
14,5 CM - 5 IN<sup>11/16</sup>



**197522**  
**FOURCHETTE DE SERVICE**  
SERVING FORK  
26,6 CM - 10 IN<sup>1/2</sup>



**197523**  
**CUILLÈRE DE SERVICE**  
SERVING SPOON  
27 CM - 10 IN<sup>5/8</sup>



**197525**  
**SERVICE À SALADE**  
SALAD SERVING SET  
30 CM - 11 IN<sup>13/16</sup>



**197527**  
**PELLE À TARTE MONOBLOC**  
PASTRY SERVER SOLID HANDLE  
25,1 CM - 9 IN<sup>7/8</sup>



**153193**  
**LOUCHE**  
**DROIT**  
SOUP LADLE  
35,5 CM - 14 IN



**154606**  
**CUILLÈRE À SAUCE**  
**DROIT**  
SAUCE LADLE  
20,4 CM - 8 IN<sup>7/16</sup>



ÉGALEMENT DISPONIBLE EN MÉTAL ARGENTÉ  
ALSO AVAILABLE IN SILVERPLATED FINISH



Possibilité de personnalisation  
Bespoke options available

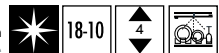



# GUEST MIROIR

All day dining



L'abus d'alcool est dangereux pour la santé  
Alcohol abuse is dangerous for your health

## GUEST CUIVRE COPPER



**230848**  
**FOURCHETTE DE TABLE**  
TABLE FORK  
21,3 CM - 8 IN<sup>3/8</sup>



**230850**  
**COUPEAU DE TABLE**  
**MONOBLOC LAME SCIE**  
TABLE KNIFE SOLID HANDLE SERRATED  
23,2 CM - 9 IN<sup>1/8</sup>



**230849**  
**CUILLÈRE DE TABLE**  
TABLE/PASTA SPOON  
21,6 CM - 8 IN<sup>1/2</sup>



**230854**  
**CUILLÈRE À DESSERT**  
DESSERT/SOUP SPOON, OVAL  
19,5 CM - 7 IN<sup>11/16</sup>



**230853**  
**FOURCHETTE À DESSERT**  
DESSERT/SALAD FORK  
19,2 CM - 7 IN<sup>9/16</sup>



**230855**  
**COUPEAU À DESSERT**  
**MONOBLOC LAME SCIE**  
DESSERT KNIFE SOLID HANDLE  
SERRATED  
20,9 CM - 8 IN<sup>3/16</sup>



**230851**  
**CUILLÈRE À CAFÉ**  
COFFEE/TEA SPOON  
14,3 CM - 5 IN<sup>5/8</sup>



**230852**  
**CUILLÈRE À MOKA**  
DEMI TASSE SPOON  
11,7 CM - 4 IN<sup>5/8</sup>



GUEST CUIVRE

Finedining





**223482**  
**FOURCHETTE DE TABLE**  
TABLE FORK  
21,3 CM - 8 IN<sup>3/8</sup>



**223483**  
**CUILLÈRE À CAFÉ**  
COFFEE/TEA SPOON  
14,3 CM - 5 IN<sup>5/8</sup>



**202995**  
**COUTEAU DE TABLE**  
**MONOBLOC LAME SCIE**  
TABLE KNIFE SOLID HANDLE SERRATED  
23,2 CM - 9 IN<sup>1/8</sup>



**223484**  
**CUILLÈRE À MOKA**  
DEMI TASSE SPOON  
11,7 CM - 4 IN<sup>5/8</sup>



**203017**  
**COUTEAU À STEAK**  
**MONOBLOC LAME SCIE**  
STEAK KNIFE SOLID HANDLE SERRATED  
23,2 CM - 9 IN<sup>1/8</sup>



**223492**  
**CUILLÈRE À SODA**  
ICED TEA SPOON  
18,9 CM - 7 IN<sup>7/16</sup>



**223481**  
**CUILLÈRE DE TABLE**  
TABLE/PASTA SPOON  
21,6 CM - 8 IN<sup>1/2</sup>



**223489**  
**FOURCHETTE À GÂTEAUX/COCKTAIL**  
PASTRY/COCKTAIL FORK  
13,9 CM - 5 IN<sup>1/2</sup>



**223491**  
**CUILLÈRE À SOUPE ANGLAISE**  
BOUILLON SPOON, ROUND  
18,5 CM - 7 IN<sup>9/16</sup>



**223493**  
**FOURCHETTE DE SERVICE**  
SERVING FORK  
26,6 CM - 10 IN<sup>1/2</sup>



**223486**  
**CUILLÈRE À DESSERT**  
DESSERT/SOUP SPOON, OVAL  
19,5 CM - 7 IN<sup>9/16</sup>



**223494**  
**CUILLÈRE DE SERVICE**  
SERVING SPOON  
27 CM - 10 IN<sup>5/8</sup>



**223485**  
**FOURCHETTE À DESSERT**  
DESSERT/SALAD FORK  
19,2 CM - 7 IN<sup>9/16</sup>



**223497**  
**PELLE À TARTE MONOBLOC**  
PASTRY SERVER SOLID HANDLE  
25,1 CM - 9 IN<sup>7/8</sup>



**210630**  
**COUTEAU À DESSERT**  
**MONOBLOC LAME SCIE**  
DESSERT KNIFE SOLID HANDLE  
SERRATED  
20,9 CM - 8 IN<sup>3/16</sup>



**203016**  
**COUTEAU À BEURRE**  
**MONOBLOC LAME UNIE**  
BUTTER KNIFE SOLID HANDLE  
19,3 CM - 7 IN<sup>9/8</sup>



**223487**  
**FOURCHETTE À POISSON**  
FISH FORK  
19,2 CM - 7 IN<sup>9/16</sup>



**223488**  
**COUTEAU À POISSON/GOURMET**  
GOURMET FISH KNIFE  
21,3 CM - 8 IN<sup>3/8</sup>

GUEST STAR

Finedining





**217139**  
**FOURCHETTE DE TABLE**  
TABLE FORK  
21,3 CM - 8 IN<sup>3/8</sup>



**217140**  
**COUTEAU DE TABLE**  
**MONOBLOC LAME SCIE**  
TABLE KNIFE SOLID HANDLE SERRATED  
23,2 CM - 9 IN<sup>1/8</sup>



**230339**  
**COUTEAU À STEAK**  
**MONOBLOC LAME SCIE**  
STEAK KNIFE SOLID HANDLE SERRATED  
23,2 CM - 9 IN<sup>1/8</sup>



**246255**  
**COUTEAU DE TABLE**  
**DROIT LAME SCIE**  
TABLE KNIFE SOLID HANDLE SERRATED  
23,2 CM - 9 IN<sup>1/8</sup>



**217141**  
**CUILLÈRE DE TABLE**  
TABLE/PASTA SPOON  
21,6 CM - 8 IN<sup>1/2</sup>



**217143**  
**CUILLÈRE À DESSERT**  
DESSERT/SOUP SPOON, OVAL  
19,5 CM - 7 IN<sup>11/16</sup>



**217144**  
**FOURCHETTE À DESSERT**  
DESSERT/SALAD FORK  
19,2 CM - 7 IN<sup>9/16</sup>



**217145**  
**COUTEAU À DESSERT**  
**MONOBLOC LAME SCIE**  
DESSERT KNIFE SOLID HANDLE  
SERRATED  
20,9 CM - 8 IN<sup>3/16</sup>



**246257**  
**COUTEAU À DESSERT**  
**DROIT LAME SCIE**  
DESSERT KNIFE SOLID HANDLE  
SERRATED  
20,9 CM - 8 IN<sup>3/16</sup>



**217142**  
**CUILLÈRE À CAFÉ**  
COFFEE/TEA SPOON  
14,3 CM - 5 IN<sup>5/8</sup>



**217146**  
**CUILLÈRE À MOKA**  
DEMI TASSE SPOON  
11,7 CM - 4 IN<sup>5/8</sup>

# GUEST VINTAGE

---

Finedining





**241006**  
**FOURCHETTE DE TABLE**  
TABLE FORK  
20,6 CM - 8 IN<sup>1/2</sup>



**241010**  
**COUTEAU DE TABLE MONOBLOC LAME SCIE**  
TABLE KNIFE SOLID HANDLE SERRATED  
23,9 CM - 9 IN<sup>7/16</sup>



**241004**  
**CUILLÈRE DE TABLE**  
TABLE/PASTA SPOON  
20,7 CM - 8 IN<sup>1/8</sup>



**241032**  
**CUILLÈRE À SOUPE ANGLAISE**  
BOUILLON SPOON, ROUND  
17,4 CM - 6 IN<sup>7/8</sup>



**241012**  
**CUILLÈRE À DESSERT**  
DESSERT/SOUP SPOON, OVAL  
18,6 CM - 7 IN<sup>5/16</sup>



**241014**  
**FOURCHETTE À DESSERT**  
DESSERT/SALAD FORK  
18,5 CM - 7 IN<sup>1/16</sup>



**241016**  
**COUTEAU À DESSERT MONOBLOC LAME UNIE**  
DESSERT KNIFE SOLID HANDLE  
21,5 CM - 8 IN<sup>7/16</sup>



**241008**  
**CUILLÈRE À CAFÉ**  
COFFEE/TEA SPOON  
14,2 CM - 5 IN<sup>9/16</sup>



**241018**  
**CUILLÈRE À MOKA**  
DEMI TASSE SPOON  
11,2 CM - 4 IN<sup>7/16</sup>



**241026**  
**FOURCHETTE À POISSON**  
FISH FORK  
18,5 CM - 7 IN<sup>5/16</sup>



**241028**  
**COUTEAU À POISSON**  
FISH KNIFE  
20,6 CM - 8 IN<sup>1/8</sup>



**241030**  
**COUTEAU À BEURRE MONOBLOC**  
BUTTER KNIFE SOLID HANDLE  
18,6 CM - 7 IN<sup>5/16</sup>



**241020**  
**CUILLÈRE DE SERVICE**  
SERVING SPOON  
26,1 CM - 10 IN<sup>1/4</sup>



**241021**  
**FOURCHETTE DE SERVICE**  
SERVING FORK  
26 CM - 10 IN<sup>1/4</sup>

EGALEMENT DISPONIBLE EN MÉTAL ARGENTÉ  
ALSO AVAILABLE IN SILVERPLATED FINISH



Possibilité de personnalisation  
Bespoke options available

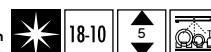



# L'EMPREINTE

---

Finedining





**239122**  
**FOURCHETTE DE TABLE**  
TABLE FORK  
20,5 CM - 8 IN<sup>1/16</sup>



**239123**  
**COUTEAU DE TABLE**  
**MONOBLOC À BOUT POINTU**  
**LAME SCIE**  
TABLE KNIFE SOLID HANDLE POINTED  
BLADE SERRATED  
23,3 CM - 9 IN<sup>3/16</sup>



**233014**  
**COUTEAU DE TABLE**  
**MONOBLOC À BOUT ROND**  
**LAME SCIE**  
TABLE KNIFE SOLID HANDLE ROUNDED  
BLADE SERRATED  
23,3 CM - 9 IN<sup>3/16</sup>



**239121**  
**CUILLÈRE DE TABLE**  
TABLE/PASTA SPOON  
20,5 CM - 8 IN<sup>1/16</sup>



**233022**  
**CUILLÈRE À SOUPE ANGLAISE**  
BOUILLON SPOON, ROUND  
18,5 CM - 7 IN<sup>5/16</sup>



**239128**  
**CUILLÈRE À DESSERT**  
DESSERT/SOUP SPOON, OVAL  
18,5 CM - 7 IN<sup>5/16</sup>



**239127**  
**FOURCHETTE À DESSERT**  
DESSERT/SALAD FORK  
18,5 CM - 7 IN<sup>5/16</sup>



**239129**  
**COUTEAU À DESSERT**  
**MONOBLOC À BOUT ROND**  
**LAME UNIE**  
DESSERT KNIFE SOLID HANDLE  
ROUNDED BLADE  
20,9 CM - 8 IN<sup>1/4</sup>



**239133**  
**COUTEAU À BEURRE**  
**MONOBLOC LAME UNIE**  
BUTTER KNIFE SOLID HANDLE  
17,5 CM - 6 IN<sup>7/8</sup>



**239125**  
**CUILLÈRE À CAFÉ**  
COFFEE/TEA SPOON  
13,9 CM - 5 IN<sup>1/2</sup>



**239126**  
**CUILLÈRE À MOKA**  
DEMI TASSE SPOON  
11,7 CM - 4 IN<sup>5/8</sup>



**239134**  
**FOURCHETTE DE SERVICE**  
SERVING FORK  
26,3 CM - 10 IN<sup>3/8</sup>



**239135**  
**CUILLÈRE DE SERVICE**  
SERVING SPOON  
26,3 CM - 10 IN<sup>3/8</sup>

L'É STARCK®

Alldaydining





**111894**  
**FOURCHETTE DE TABLE**  
 TABLE FORK  
 20,4 CM - 8 IN<sup>1/16</sup>



**111921**  
**COUTEAU DE TABLE**  
**MONOBLOC LAME SCIE**  
 TABLE KNIFE SOLID HANDLE SERRATED  
 23 CM - 9 IN<sup>1/16</sup>



**111891**  
**CUILÈRE DE TABLE**  
 TABLE/PASTA SPOON  
 20,4 CM - 8 IN<sup>1/16</sup>



**111904**  
**CUILÈRE À DESSERT**  
 DESSERT/SOUP SPOON, OVAL  
 18 CM - 7 IN<sup>1/16</sup>



**111907**  
**FOURCHETTE À DESSERT**  
 DESSERT/SALAD FORK  
 18 CM - 7 IN<sup>1/16</sup>



**210631**  
**COUTEAU À DESSERT**  
**MONOBLOC LAME SCIE**  
 DESSERT KNIFE SOLID HANDLE  
 SERRATED  
 20,3 CM - 8 IN



**181112**  
**TARTINEUR**  
**XY**  
 BUTTER SPREADER  
 16 CM - 6 IN<sup>5/16</sup>



**111897**  
**CUILÈRE À CAFÉ**  
 COFFEE/TEA SPOON  
 13,6 CM - 5 IN<sup>3/8</sup>



**114437**  
**CUILÈRE À MOKA**  
 DEMI TASSE SPOON  
 11 CM - 4 IN<sup>5/16</sup>

EGALEMENT DISPONIBLE EN MÉTAL ARGENTÉ  
 ALSO AVAILABLE IN SILVERPLATED FINISH



Possibilité de personnalisation  
 Bespoke options available



NORWAY

Alldaydining





**235927**  
**FOURCHETTE DE TABLE**  
TABLE FORK  
19,9 CM - 7 IN<sup>13/16</sup>



**235930**  
**COUTEAU DE TABLE**  
**MONOBLOC LAME SCIE**  
TABLE KNIFE SOLID HANDLE SERRATED  
23,2 CM - 9 IN<sup>1/8</sup>



**235928**  
**CUILLÈRE DE TABLE**  
TABLE/PASTA SPOON  
19,9 CM - 7 IN<sup>13/16</sup>



**235938**  
**CUILLÈRE À SOUPE ANGLAISE**  
BOUILLON SPOON, ROUND  
18,4 CM - 7 IN<sup>1/4</sup>



**235934**  
**CUILLÈRE À DESSERT**  
DESSERT/SOUP SPOON, OVAL  
18,4 CM - 7 IN<sup>1/4</sup>



**235933**  
**FOURCHETTE À DESSERT**  
DESSERT/SALAD FORK  
18,4 CM - 7 IN<sup>1/4</sup>



**235935**  
**COUTEAU À DESSERT**  
**MONOBLOC LAME SCIE**  
DESSERT KNIFE SOLID HANDLE SERRATED  
20,9 CM - 8 IN<sup>3/16</sup>



**235939**  
**COUTEAU À BEURRE**  
**MONOBLOC LAME UNIE**  
BUTTER KNIFE SOLID HANDLE  
16,5 CM - 6 IN<sup>1/2</sup>



**235929**  
**CUILLÈRE À CAFÉ**  
COFFEE/TEA SPOON  
13,9 CM - 5 IN<sup>1/2</sup>



**235932**  
**CUILLÈRE À MOKA**  
DEMI TASSE SPOON  
10,9 CM - 4 IN<sup>5/16</sup>



**235937**  
**FOURCHETTE À GÂTEAUX/**  
**COCKTAIL**  
PASTRY/COCKTAIL FORK  
14,1 CM - 5 IN<sup>3/16</sup>



**231218**  
**FOURCHETTE DE SERVICE**  
**GOUTTE**  
SERVING FORK  
26,6 CM - 10 IN<sup>1/2</sup>



**231219**  
**CUILLÈRE DE SERVICE**  
**GOUTTE**  
SERVING SPOON  
26,6 CM - 10 IN<sup>1/2</sup>



**231221**  
**PELLE À TARTE MONOBLOC**  
**GOUTTE**  
PASTRY SERVER SOLID HANDLE  
25,2 CM - 9 IN<sup>15/16</sup>



**231220**  
**LOUCHE**  
**GOUTTE**  
SOUP LADLE  
29 CM - 11 IN<sup>7/16</sup>

EGALEMENT DISPONIBLE EN MÉTAL ARGENTÉ  
ALSO AVAILABLE IN SILVERPLATED FINISH



Possibilité de personnalisation  
Bespoke options available



ONDE

Alldaydining





**236968**  
**FOURCHETTE DE TABLE**  
 TABLE FORK  
 19,9 CM - 7 IN<sup>13/16</sup>



**239336**  
**COUTEAU DE TABLE**  
**MONOBLOC LAME SCIE**  
 TABLE KNIFE SOLID HANDLE SERRATED  
 23,2 CM - 9 IN<sup>1/8</sup>



**236970**  
**CUILLÈRE DE TABLE**  
 TABLE/PASTA SPOON  
 19,9 CM - 7 IN<sup>13/16</sup>



**236976**  
**CUILLÈRE À SOUPE ANGLAISE**  
 BOUILLON SPOON, ROUND  
 17,9 CM - 7 IN<sup>1/16</sup>



**236971**  
**CUILLÈRE À DESSERT**  
 DESSERT/SOUP SPOON, OVAL  
 17,9 CM - 7 IN<sup>1/16</sup>



**236972**  
**FOURCHETTE À DESSERT**  
 DESSERT/SALAD FORK  
 17,9 CM - 7 IN<sup>1/16</sup>



**239337**  
**COUTEAU À DESSERT**  
**MONOBLOC LAME UNIE**  
 DESSERT KNIFE SOLID HANDLE  
 20,9 CM - 8 IN<sup>3/16</sup>



**236978**  
**COUTEAU À BEURRE**  
**MONOBLOC LAME UNIE**  
 BUTTER KNIFE SOLID HANDLE  
 16,5 CM - 6 IN<sup>1/2</sup>



**236974**  
**CUILLÈRE À CAFÉ**  
 COFFEE/TEA SPOON  
 13,9 CM - 5 IN<sup>1/2</sup>



**236975**  
**CUILLÈRE À MOKA**  
 DEMI TASSE SPOON  
 10,9 CM - 4 IN<sup>5/16</sup>



**236977**  
**FOURCHETTE À COCKTAIL/**  
**ESCARGOTS**  
 SNAIL/COCKTAIL FORK  
 14,1 CM - 5 IN<sup>9/16</sup>



**236981**  
**FOURCHETTE DE SERVICE**  
 SERVING FORK  
 26,6 CM - 10 IN<sup>1/2</sup>



**236982**  
**CUILLÈRE DE SERVICE**  
 SERVING SPOON  
 26,6 CM - 10 IN<sup>1/2</sup>



**237180**  
**PELLE À TARTE MONOBLOC**  
 PASTRY SERVER SOLID HANDLE  
 25,2 CM - 9 IN<sup>5/16</sup>

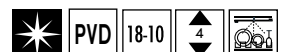



# ONDE GOLD

---

Finedining





**163598**  
**FOURCHETTE DE TABLE**  
 TABLE FORK  
 20,2 CM - 7 IN<sup>15/16</sup>



**11970**  
**COUTEAU DE TABLE**  
**MONOBLOC LAME SCIE**  
 TABLE KNIFE SOLID HANDLE SERRATED  
 22,9 CM - 9 IN



**163597**  
**CUILLÈRE DE TABLE**  
 TABLE/PASTA SPOON  
 20,4 CM - 8 IN



**163602**  
**CUILLÈRE À DESSERT**  
 DESSERT/SOUP SPOON, OVAL  
 18,4 CM - 7 IN<sup>1/4</sup>



**163603**  
**FOURCHETTE À DESSERT**  
 DESSERT/SALAD FORK  
 18,5 CM - 7 IN<sup>1/4</sup>



**111076**  
**COUTEAU À DESSERT**  
**MONOBLOC LAME UNIE**  
 DESSERT KNIFE SOLID HANDLE  
 20,4 CM - 8 IN



**181112**  
**TARTINEUR**  
**XY**  
 BUTTER SPREADER  
 16 CM - 6 IN<sup>5/16</sup>



**163599**  
**CUILLÈRE À CAFÉ**  
 COFFEE/TEA SPOON  
 14,1 CM - 5 IN<sup>1/2</sup>

EGALEMENT DISPONIBLE EN MÉTAL ARGENTÉ  
 ALSO AVAILABLE IN SILVERPLATED FINISH



Possibilité de personnalisation  
 Bespoke options available



OVATION

Finedining

MADE IN FRANCE





**246423**  
**FOURCHETTE DE TABLE**  
 TABLE FORK  
 21 CM - 8 IN<sup>1/4</sup>



**246427**  
**COUTEAU DE TABLE**  
**MONOBLOC LAME SCIE**  
 TABLE KNIFE SOLID HANDLE SERRATED  
 23,5 CM - 9 IN<sup>1/4</sup>



**246425**  
**CUILLÈRE DE TABLE**  
 TABLE/PASTA SPOON  
 20,8 CM - 8 IN<sup>3/16</sup>



**246439**  
**CUILLÈRE À SOUPE ANGLAISE**  
 BOUILLON SPOON  
 18,1 CM - 7 IN<sup>1/8</sup>



**246431**  
**CUILLÈRE À DESSERT**  
 DESSERT/SOUP SPOON, OVAL  
 18,9 CM - 7 IN<sup>7/16</sup>



**246429**  
**FOURCHETTE À DESSERT/POISSON**  
 FISH/DESSERT FORK  
 18,9 CM - 7 IN<sup>7/16</sup>



**246441**  
**COUTEAU À POISSON/GOURMET**  
 GOURMET/FISH KNIFE  
 20,5 CM - 8 IN<sup>1/16</sup>



**246433**  
**COUTEAU À DESSERT**  
**MONOBLOC LAME UNIE**  
 DESSERT KNIFE SOLID HANDLE  
 21,1 CM - 8 IN<sup>5/16</sup>



**246445**  
**COUTEAU À BEURRE**  
**MONOBLOC LAME UNIE**  
 BUTTER KNIFE SOLID HANDLE  
 18,3 CM - 7 IN<sup>3/16</sup>



**246435**  
**CUILLÈRE À CAFÉ**  
 COFFEE/TEA SPOON  
 14,5 CM - 5 IN<sup>11/16</sup>



**246437**  
**CUILLÈRE À MOKA**  
 DEMI TASSE SPOON  
 11,6 CM - 4 IN<sup>9/16</sup>



**246443**  
**FOURCHETTE À GATEAUX/COCKTAIL**  
 PASTRY/COCKTAIL FORK  
 14,5 CM - 5 IN<sup>11/16</sup>



**246448**  
**FOURCHETTE DE SERVICE**  
 SERVING FORK  
 26,3 CM - 10 IN<sup>3/8</sup>



**246447**  
**CUILLÈRE DE SERVICE**  
 SERVING SPOON  
 26,3 CM - 10 IN<sup>3/8</sup>



# RIVAGE

---

Alldaydining

**NEW**





**205540**  
**FOURCHETTE DE TABLE**  
TABLE FORK  
20,9 CM - 8 IN<sup>3/16</sup>



**159484**  
**COUTEAU DE TABLE N°1**  
**MONOBLOC LAME SCIE**  
TABLE KNIFE SOLID HANDLE SERRATED  
23,2 CM - 9 IN<sup>3/8</sup>



**235481**  
**COUTEAU DE TABLE**  
**MONOBLOC LAME SCIE**  
**GUEST**  
TABLE KNIFE SOLID HANDLE SERRATED  
23,7 CM - 9 IN<sup>5/16</sup>



**159451**  
**COUTEAU À STEAK**  
**MONOBLOC LAME SCIE**  
**GOURMET**  
STEAK KNIFE SOLID HANDLE SERRATED  
23,5 CM - 9 IN<sup>1/4</sup>



**235482**  
**COUTEAU DESSERT**  
**MONOBLOC LAME UNIE**  
**GUEST**  
DESSERT KNIFE SOLID HANDLE  
21,3 CM - 8 IN<sup>3/8</sup>



**205541**  
**CUILLÈRE DE TABLE**  
TABLE/PASTA SPOON  
20,9 CM - 8 IN<sup>1/4</sup>



**205547**  
**CUILLÈRE À DESSERT**  
DESSERT/SOUP SPOON, OVAL  
18,4 CM - 7 IN<sup>1/4</sup>



**205546**  
**FOURCHETTE À DESSERT**  
DESSERT/SALAD FORK  
18,4 CM - 7 IN<sup>1/4</sup>



**159492**  
**COUTEAU À DESSERT N°1**  
**MONOBLOC LAME UNIE**  
DESSERT KNIFE SOLID HANDLE  
20,4 CM - 8 IN<sup>1/16</sup>



**181112**  
**TARTINEUR**  
**XY**  
BUTTER SPREADER  
16 CM - 6 IN<sup>3/16</sup>



**205544**  
**FOURCHETTE À POISSON**  
FISH FORK  
18,4 CM - 7 IN<sup>1/4</sup>



**205545**  
**COUTEAU À POISSON/**  
**GOURMET**  
GOURMET FISH KNIFE  
20,7 CM - 8 IN<sup>1/8</sup>



**205543**  
**CUILLÈRE À CAFÉ**  
COFFEE/TEA SPOON  
14 CM - 5 IN<sup>1/2</sup>



**159512**  
**CUILLÈRE À MOKA**  
DEMI TASSE SPOON  
11,1 CM - 4 IN<sup>3/8</sup>



**190018**  
**CUILLÈRE À SODA**  
**DROIT**  
ICED TEA SPOON  
19 CM - 7 IN<sup>1/2</sup>



**205548**  
**FOURCHETTE À GÂTEAUX/**  
**COCKTAIL**  
PASTRY/COCKTAIL FORK  
14,3 CM - 5 IN<sup>5/8</sup>



**190424**  
**FOURCHETTE À HÙÎTRES**  
**DROIT**  
OYSTER FORK  
14,5 CM - 5 IN<sup>1/16</sup>



**159501**  
**FOURCHETTE DE SERVICE**  
SERVING FORK  
26 CM - 10 IN<sup>1/4</sup>



**159500**  
**CUILLÈRE DE SERVICE**  
SERVING SPOON  
26 CM - 10 IN<sup>1/4</sup>



**153193**  
**LOUCHE**  
**DROIT**  
SOUP LADLE  
35,5 CM - 14 IN



**154606**  
**CUILLÈRE À SAUCE**  
**DROIT**  
SAUCE SPOON  
20,4 CM - 8 IN<sup>1/16</sup>

EGALEMENT DISPONIBLE EN MÉTAL ARGENTÉ  
ALSO AVAILABLE IN SILVERPLATED FINISH



Possibilité de personnalisation  
Bespoke options available



# SOLSTICE

Finedining





**242668**  
**FOURCHETTE DE TABLE**  
TABLE FORK  
20,1 CM - 7 IN<sup>15/16</sup>



**242674**  
**COUPEAU DE TABLE**  
**MONOBLOC LAME SCIE**  
TABLE KNIFE SOLID HANDLE SERRATED  
23,5 CM - 9 IN<sup>1/4</sup>



**242665**  
**CUILLÈRE DE TABLE**  
TABLE/PASTA SPOON  
20,3 CM - 8 IN



**242689**  
**CUILLÈRE À SOUPE ANGLAISE**  
BOUILLON SPOON, ROUND  
17,9 CM - 7 IN<sup>1/16</sup>



**242677**  
**CUILLÈRE À DESSERT**  
DESSERT/SOUP SPOON, OVAL  
17,8 CM - 7 IN



**242680**  
**FOURCHETTE À DESSERT**  
DESSERT/SALAD FORK  
17,7 CM - 6 IN<sup>15/16</sup>



**242683**  
**COUPEAU À DESSERT**  
**MONOBLOC LAME UNIE**  
DESSERT KNIFE SOLID HANDLE  
20,7 CM - 8 IN<sup>1/8</sup>



**242705**  
**COUPEAU À BEURRE MONOBLOC**  
BUTTER KNIFE SOLID HANDLE  
18,1 CM - 8 IN<sup>1/8</sup>



**242671**  
**CUILLÈRE À CAFÉ**  
COFFEE/TEA SPOON  
13,7 CM - 5 IN<sup>3/8</sup>



**242686**  
**CUILLÈRE À MOKA**  
COFFEE/TEA SPOON  
11,1 CM - 4 IN<sup>5/16</sup>



# SUPERNATURE

Finedining



MADE IN FRANCE





**205559**  
**FOURCHETTE DE TABLE**  
TABLE FORK  
21,3 CM - 8 IN<sup>3/8</sup>



**193776**  
**COUTEAU DE TABLE**  
**MONOBLOC LAME SCIE**  
TABLE KNIFE SOLID HANDLE SERRATED  
23,3 CM - 9 IN<sup>3/16</sup>



**205560**  
**CUILLÈRE DE TABLE**  
TABLE/PASTA SPOON  
20,5 CM - 8 IN<sup>1/16</sup>



**205561**  
**CUILLÈRE À SOUPE ANGLAISE**  
BOUILLON SPOON, ROUND  
18,5 CM - 7 IN<sup>5/16</sup>



**205567**  
**CUILLÈRE GOURMANDE**  
DESSERT /SOUP SPOON, OVAL  
18,6 CM - 7 IN<sup>5/16</sup>



**205566**  
**FOURCHETTE GOURMANDE**  
DESSERT/SALAD FORK  
18,6 CM - 7 IN<sup>5/16</sup>



**181111**  
**COUTEAU À DESSERT**  
**MONOBLOC LAME UNIE**  
DESSERT KNIFE SOLID HANDLE  
20,6 CM - 8 IN<sup>1/8</sup>



**181112**  
**TARTINEUR**  
BUTTER SPREADER  
16 CM - 6 IN<sup>5/16</sup>



**205563**  
**FOURCHETTE À POISSON**  
FISH FORK  
20 CM - 7 IN<sup>7/8</sup>



**205564**  
**SPATULE GOURMET**  
GOURMET SPATULA  
20,2 CM - 7 IN<sup>15/16</sup>



**205565\***  
**FOURCHETTE GOURMET**  
GOURMET FORK  
20 CM - 7 IN<sup>7/8</sup>



**205562**  
**CUILLÈRE À CAFÉ**  
COFFEE/TEA SPOON  
14,3 CM - 5 IN<sup>5/8</sup>



**181109**  
**CUILLÈRE À MOKA**  
DEMI TASSE SPOON  
11 CM - 4 IN<sup>5/16</sup>



**190018**  
**CUILLÈRE À SODA**  
ICED TEA SPOON  
19 CM - 7 IN<sup>1/2</sup>



**181119**  
**FOURCHETTE MISE EN BOUCHE**  
COCKTAIL FORK  
15,5 CM - 6 IN<sup>1/8</sup>



**181120**  
**SPATULE MISE EN BOUCHE**  
COCKTAIL SPATULA  
15,5 CM - 6 IN<sup>1/8</sup>



**181121**  
**CUILLÈRE MISE EN BOUCHE**  
COCKTAIL SPOON  
11,6 CM - 4 IN<sup>3/16</sup>



**190424**  
**FOURCHETTE À HÙITRES**  
OYSTER FORK  
14,5 CM - 5 IN<sup>11/16</sup>



**181114**  
**FOURCHETTE DE SERVICE**  
SERVING FORK  
26 CM - 10 IN<sup>1/4</sup>



**181113**  
**CUILLÈRE DE SERVICE**  
SERVING SPOON  
26 CM - 10 IN<sup>1/4</sup>



**181122**  
**SPATULE DE SERVICE**  
SERVING SPATULA  
25 CM - 9 IN<sup>13/16</sup>



**189999**  
**SERVICE À SALADE**  
SALAD SERVING SET  
30 CM - 11 IN<sup>13/16</sup>



**153193**  
**LOUCHE**  
SOUP LADLE  
35,5 CM - 14 IN



**154606**  
**LOUCHE À SAUCE**  
SAUCE LADLE  
20,4 CM - 8 IN<sup>11/16</sup>

EGALEMENT DISPONIBLE EN MÉTAL ARGENTÉ  
ALSO AVAILABLE IN SILVERPLATED FINISH



\*Arrêt à épuisement des stocks  
Until stock limited

Possibilité de personnalisation  
Bespoke options available

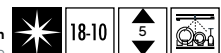

XY

Finedining





**205568**  
**FOURCHETTE DE TABLE**  
TABLE FORK  
21,3 CM - 8 IN<sup>3/8</sup>



**195028**  
**COUTEAU DE TABLE**  
**MONOBLOC LAME SCIE**  
TABLE KNIFE SOLID HANDLE SERRATED  
23,3 CM - 9 IN<sup>3/16</sup>



**205569**  
**CUILLÈRE DE TABLE**  
TABLE/PASTA SPOON  
20,5 CM - 8 IN<sup>1/16</sup>



**200483**  
**CUILLÈRE À SOUPE ANGLAISE**  
BOUILLON SPOON, ROUND  
18,5 CM - 7 IN<sup>5/16</sup>



**205575**  
**CUILLÈRE GOURMANDE**  
DESSERT/SOUP SPOON, OVAL  
18,6 CM - 7 IN<sup>5/16</sup>



**205574**  
**FOURCHETTE GOURMANDE**  
DESSERT/SALAD FORK  
18,6 CM - 7 IN<sup>5/16</sup>



**195031**  
**COUTEAU À DESSERT**  
**MONOBLOC LAME UNIE**  
DESSERT KNIFE SOLID HANDLE  
20,6 CM - 8 IN<sup>1/8</sup>



**195036**  
**TARTINEUR**  
BUTTER SPREADER  
16 CM - 6 IN<sup>5/16</sup>



**205571**  
**FOURCHETTE À POISSON**  
FISH FORK  
20 CM - 7 IN<sup>7/8</sup>



**205572**  
**SPATULE GOURMET**  
GOURMET SPATULA  
20,2 CM - 7 IN<sup>15/16</sup>



**205573\***  
**FOURCHETTE GOURMET**  
GOURMET FORK  
20 CM - 7 IN<sup>7/8</sup>



**205570**  
**CUILLÈRE À CAFÉ**  
COFFEE/TEA SPOON  
14,3 CM - 5 IN<sup>5/8</sup>



**195034**  
**CUILLÈRE À MOKA**  
DEMI TASSE SPOON  
11 CM - 4 IN<sup>9/16</sup>



**196674**  
**CUILLÈRE À SODA**  
ICED TEA SPOON  
19 CM - 7 IN<sup>1/2</sup>



**195039**  
**FOURCHETTE MISE EN BOUCHE**  
COCKTAIL FORK  
15,5 CM - 6 IN<sup>1/8</sup>



**195042**  
**SPATULE MISE EN BOUCHE**  
COCKTAIL SPATULA  
15,5 CM - 6 IN<sup>1/8</sup>



**195041**  
**CUILLÈRE MISE EN BOUCHE**  
COCKTAIL SPOON  
11,6 CM - 4 IN<sup>9/16</sup>



**196014**  
**FOURCHETTE À HÙÎTRES**  
OYSTER FORK  
14,1 CM - 5 IN<sup>9/16</sup>



**199773**  
**FOURCHETTE DE SERVICE**  
SERVING FORK  
26 CM - 10 IN<sup>1/4</sup>



**199774**  
**CUILLÈRE DE SERVICE**  
SERVING SPOON  
26 CM - 10 IN<sup>1/4</sup>



**199769**  
**SPATULE DE SERVICE**  
SERVING SPATULA  
25 CM - 9 IN<sup>13/16</sup>



**199771**  
**SERVICE À SALADE**  
SALAD SERVING SET  
30 CM - 11 IN<sup>13/16</sup>

\*Arrêt à épuisement des stocks  
Until stock limited

Possibilité de personnalisation  
Bespoke options available



# XY BLACK MIROIR

---

Finedining





L'abus d'alcool est dangereux pour la santé  
Alcohol abuse is dangerous for your health

# **LES PIÈCES COMPLÉMENTAIRES**

Additional Pieces

## MIRAGE LES ESSENCES

MANCHES EN BOIS VERITABLE GENUINE WOODEN HANDLES



**243524**  
**COUTEAU À STEAK LAME UNIE MANCHE OLIVIER**  
STEAK KNIFE SOLID HANDLE OLIVE WOOD HANDLE  
23 CM - 9 IN<sup>5/16</sup>



**243528**  
**COUTEAU À STEAK LAME UNIE MANCHE PICANA**  
STEAK KNIFE SOLID HANDLE PICANA HANDLE  
23 CM - 9 IN<sup>5/16</sup>



**243525**  
**COUTEAU À STEAK LAME UNIE MANCHE ÉBÈNE**  
STEAK KNIFE SOLID HANDLE EBONY HANDLE  
23 CM - 9 IN<sup>5/16</sup>

## MIRAGE



**226261**  
**COUTEAU DE TABLE/ STEAK LAME UNIE ANTHRACITE**  
BLACK TABLE STEAK KNIFE  
23 CM - 9 IN<sup>5/16</sup>



**226263**  
**COUTEAU DE TABLE/ STEAK LAME UNIE BLANC**  
WHITE TABLE STEAK KNIFE  
23 CM - 9 IN<sup>5/16</sup>

## LE PHIL



**246174**  
**COUTEAU À STEAK MONOBLOC LAME UNIE**  
STEAK KNIFE SOLID HANDLE  
23,7 CM - 9 IN<sup>5/16</sup>

## LE PHIL VINTAGE **NEW**



**247404**  
**COUTEAU À STEAK MONOBLOC LAME UNIE**  
STEAK KNIFE SOLID HANDLE  
23,7 CM - 9 IN<sup>5/16</sup>

## COUTEAUX ORFÈVRE

HOLLOW HANDLE



**122759**  
**COUTEAU À STEAK MANCHE ORFEVRE LAME SCIE BLOIS**  
BLOIS STEAK KNIFE HOLLOW HANDLE SERRATED  
23,9 CM - 9 IN<sup>7/16</sup>



**127654**  
**COUTEAU À STEAK MANCHE ORFEVRE LAME SCIE FLORENCIA**  
FLORENCIA STEAK KNIFE HOLLOW HANDLE SERRATED  
23,9 CM - 9 IN<sup>7/16</sup>



**122746**  
**COUTEAU À STEAK MANCHE ORFEVRE LAME SCIE LUTECE**  
LUTECE STEAK KNIFE HOLLOW HANDLE SERRATED  
23,8 CM - 9 IN<sup>3/8</sup>



**186278**  
**COUTEAU À STEAK MANCHE ORFEVRE LAME SCIE MARQUISE**  
MARQUISE STEAK KNIFE HOLLOW HANDLE SERRATED  
23,9 CM - 9 IN<sup>7/16</sup>



**128841**  
**COUTEAU À STEAK MANCHE ORFEVRE LAME SCIE MILADY**  
MILADY STEAK KNIFE HOLLOW HANDLE SERRATED  
23,9 CM - 9 IN<sup>7/16</sup>



**105801**  
**COUTEAU À STEAK MANCHE ORFEVRE LAME SCIE VERLAINE**  
VERLAINE STEAK KNIFE HOLLOW HANDLE SERRATED  
23,9 CM - 9 IN<sup>7/16</sup>



# COUTEAUX STEAK

---

  
MADE IN FRANCE



## COUTEAUX STEAK

## STEAK KNIVES



**199761**  
**COUTEAU À STEAK MONOBLOC LAME SCIE ASTRÉE CISELÉ**  
 ASTREE CISELÉ STEAK KNIFE SOLID HANDLE SERRATED  
 22,8 CM - 9 IN



**160433**  
**COUTEAU À STEAK MONOBLOC LAME SCIE CONFIDENCE**  
 CONFIDENCE STEAK KNIFE SOLID HANDLE SERRATED  
 23,6 CM - 9 IN<sup>5/16</sup>



**159451**  
**COUTEAU À STEAK MONOBLOC LAME SCIE GOURMET**  
 GOURMET STEAK KNIFE SOLID HANDLE SERRATED  
 23,5 CM - 9 IN<sup>1/4</sup>



**197521**  
**COUTEAU À STEAK MONOBLOC LAME SCIE GUEST**  
 GUEST STEAK KNIFE SOLID HANDLE SERRATED  
 23,2 CM - 9 IN<sup>1/8</sup>



**203017**  
**COUTEAU À STEAK MONOBLOC LAME SCIE GUEST STAR**  
 GUEST STAR STEAK KNIFE SOLID HANDLE SERRATED  
 23,2 CM - 9 IN<sup>1/8</sup>



**230339**  
**COUTEAU À STEAK MONOBLOC LAME SCIE GUEST VINTAGE**  
 GUEST VINTAGE STEAK KNIFE SOLID HANDLE SERRATED  
 23,2 CM - 9 IN<sup>1/8</sup>



**160427**  
**COUTEAU À STEAK MONOBLOC LAME SCIE MIKADO**  
 MIKADO STEAK KNIFE SOLID HANDLE SERRATED  
 23,2 CM - 9 IN<sup>1/8</sup>



**230293**  
**COUTEAU À STEAK MONOBLOC LAME SCIE MIKADO VINTAGE**  
 MIKADO VINTAGE STEAK KNIFE SOLID HANDLE SERRATED  
 23,2 CM - 9 IN<sup>1/8</sup>



**160424**  
**COUTEAU À STEAK MONOBLOC LAME SCIE VIEUX PARIS**  
 VIEUX PARIS STEAK KNIFE SOLID HANDLE SERRATED  
 23,2 CM - 9 IN<sup>1/8</sup>

## PETIT GOURMET/ENFANT

## KID



**207257**  
**FOURCHETTE À DESSERT**  
 DESSERT/SALAD FORK  
 16,5 CM - 6 IN<sup>1/2</sup>



**207258**  
**CUILLÈRE À DESSERT**  
 DESSERT/SOUP SPOON, OVAL  
 16,5 CM - 6 IN<sup>1/2</sup>



**207259**  
**COUTEAU À DESSERT MONOBLOC LAME UNIE**  
 DESSERT KNIFE SOLID HANDLE  
 17,7 CM - 6 IN<sup>5/16</sup>



**207256**  
**CUILLÈRE À CAFÉ**  
 COFFEE/TEA SPOON  
 13,2 CM - 5 IN<sup>3/16</sup>

Possibilité de personnalisation  
 Bespoke options available



# PIÈCES COMPLÉMENTAIRES

Additional pieces



**VERLAINE**

**BLOIS**



**105795  
FOURCHETTE  
À GÂTEAUX/  
COCKTAIL**  
PASTRY/  
COCKTAIL FORK  
13,8 CM - 5 IN<sup>7/16</sup>



**104480  
FOURCHETTE  
À GÂTEAUX/  
COCKTAIL**  
PASTRY/  
COCKTAIL FORK  
13,8 CM - 5 IN<sup>7/16</sup>



**002185  
FOURCHETTE  
DE SERVICE**  
SERVING FORK  
24,8 CM - 9 IN<sup>3/4</sup>



**195757  
FOURCHETTE  
DE SERVICE**  
SERVING FORK  
24,8 CM - 9 IN<sup>3/4</sup>



**002186  
CUILLÈRE  
DE SERVICE**  
SERVING SPOON  
25 CM - 9 IN<sup>13/16</sup>



**195755  
CUILLÈRE  
DE SERVICE**  
SERVING SPOON  
25 CM - 9 IN<sup>13/16</sup>



**040646  
SERVICE  
À SALADE**  
SALADE  
SERVING SET  
25,8 CM - 10 IN<sup>3/16</sup>



**195750  
SERVICE  
À SALADE**  
SALADE  
SERVING SET  
25,7 CM - 10 IN<sup>1/8</sup>



**083340  
PELLE À TARTE  
MONOBLOC**  
PASTRY SERVER  
SOLID HANDLE  
24,9 CM - 9 IN<sup>3/16</sup>



**195753  
PELLE À TARTE  
MONOBLOC**  
PASTRY SERVER  
SOLID HANDLE  
24,9 CM - 9 IN<sup>3/16</sup>



**097717  
LOUCHE**  
SOUP LADLE  
29,8 CM - 11 IN<sup>3/4</sup>



**195762  
LOUCHE**  
SOUP LADLE  
29,8 CM - 11 IN<sup>3/4</sup>



**002179  
LOUCHE  
À SAUCE**  
SAUCE LADLE  
15,7 CM - 6 IN<sup>3/16</sup>



**195759  
LOUCHE  
À SAUCE**  
SAUCE LADLE  
15,7 CM - 6 IN<sup>3/16</sup>



**195757  
FOURCHETTE  
À DÉCOUPER**  
CARVING FORK  
24,8 CM - 9 IN<sup>3/4</sup>



**189511  
COUTEAU  
À DÉCOUPER  
MANCHE ORFÈVRE  
LAME UNIE**  
CARVING KNIFE  
HOLLOW HANDLE  
28,7 CM - 11 IN<sup>5/16</sup>

**CUILLÈRE À SODA**  
ICED TEA SPOON

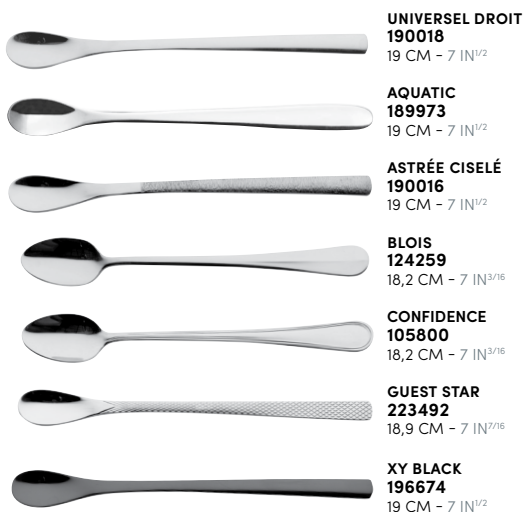

**UNIVERSEL DROIT**  
190018  
19 CM - 7 IN<sup>1/2</sup>

**AQUATIC**  
189973  
19 CM - 7 IN<sup>1/2</sup>

**ASTRÉE CISELÉ**  
190016  
19 CM - 7 IN<sup>1/2</sup>

**BLOIS**  
124259  
18,2 CM - 7 IN<sup>3/16</sup>

**CONFIDENCE**  
105800  
18,2 CM - 7 IN<sup>3/16</sup>

**GUEST STAR**  
223492  
18,9 CM - 7 IN<sup>7/16</sup>

**XY BLACK**  
196674  
19 CM - 7 IN<sup>1/2</sup>



**MODULO**  
162724  
**CUILLÈRE À AGRUMES**  
CITRUS FRUITS SPOON  
15,3 CM - 6 IN

**MODULO**  
162730  
**CURETTE À CRUSTACÉS**  
SEAFOOD SCRAPER  
19,1 CM - 7 IN<sup>1/2</sup>

**AQUATIC**  
189971  
**COUPEAU À BEURRE**  
**MONOBLOC LAME UNIE**  
BUTTER KNIFE SOLID HANDLE  
18,9 CM - 7 IN<sup>7/16</sup>

**181112**  
**TARTINEUR**  
BUTTER SPREADER  
16 CM - 6 IN<sup>5/16</sup>

**FOURCHETTE À HÛÎTRES**  
OYSTER FORKS

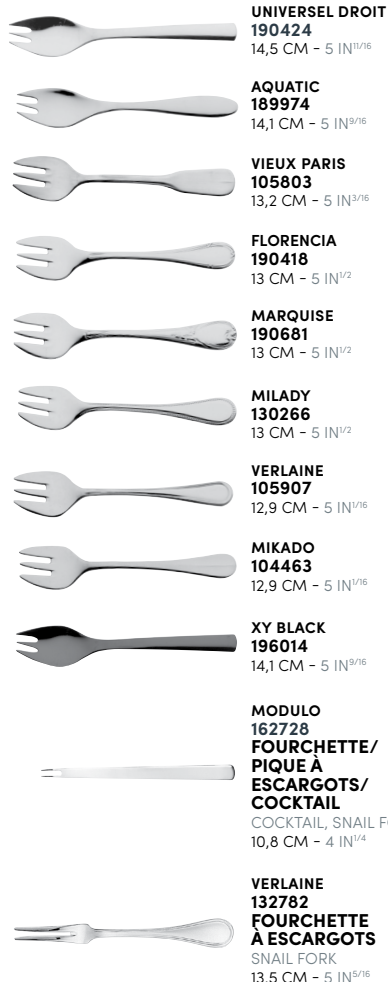

**UNIVERSEL DROIT**  
190424  
14,5 CM - 5 IN<sup>1/16</sup>

**AQUATIC**  
189974  
14,1 CM - 5 IN<sup>9/16</sup>

**VIEUX PARIS**  
105803  
13,2 CM - 5 IN<sup>3/16</sup>

**FLORENCIA**  
190418  
13 CM - 5 IN<sup>1/2</sup>

**MARQUISE**  
190681  
13 CM - 5 IN<sup>1/2</sup>

**MILADY**  
130266  
13 CM - 5 IN<sup>1/2</sup>

**VERLAINE**  
105907  
12,9 CM - 5 IN<sup>1/16</sup>

**MIKADO**  
104463  
12,9 CM - 5 IN<sup>1/16</sup>

**XY BLACK**  
196014  
14,1 CM - 5 IN<sup>9/16</sup>

**MODULO**  
162728  
**FOURCHETTE/**  
**PIQUE À**  
**ESCARGOTS/**  
**COCKTAIL**  
COCKTAIL, SNAIL FORK  
10,8 CM - 4 IN<sup>1/4</sup>

**VERLAINE**  
132782  
**FOURCHETTE**  
**À ESCARGOTS**  
SNAIL FORK  
13,5 CM - 5 IN<sup>5/16</sup>

**ACCESSOIRES PLATERIE**  
HOLLOWWARE ACCESSORIES

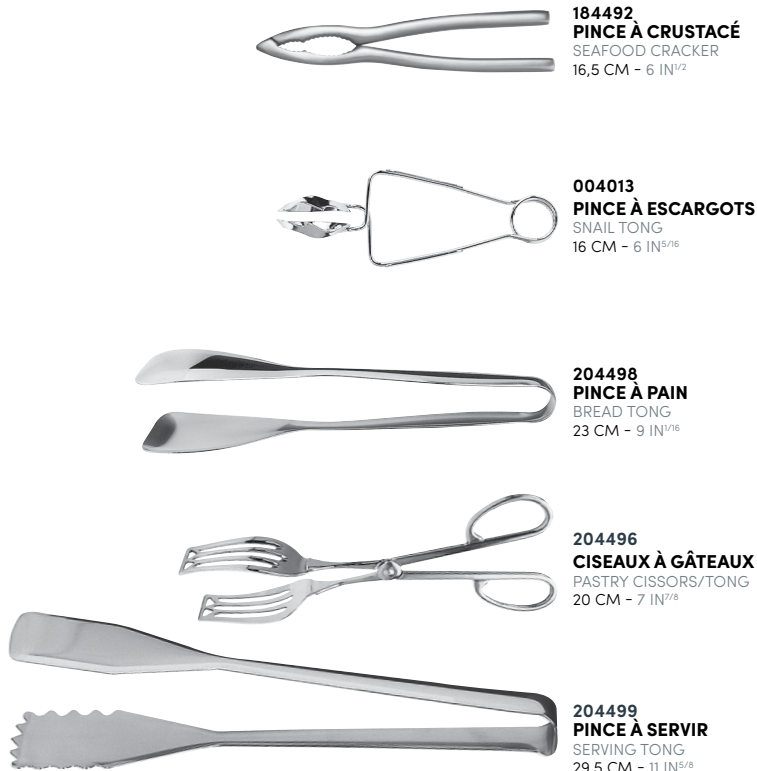

**184492**  
**PINCE À CRUSTACÉ**  
SEAFOOD CRACKER  
16,5 CM - 6 IN<sup>1/2</sup>

**004013**  
**PINCE À ESCARGOTS**  
SNAIL TONG  
16 CM - 6 IN<sup>5/16</sup>

**204498**  
**PINCE À PAIN**  
BREAD TONG  
23 CM - 9 IN<sup>1/16</sup>

**204496**  
**CISEAUX À GÂTEAUX**  
PASTRY CISSORS/TONG  
20 CM - 7 IN<sup>7/8</sup>

**204499**  
**PINCE À SERVIR**  
SERVING TONG  
29,5 CM - 11 IN<sup>5/8</sup>



# LA VAISSELLE

Dinnerware

DEGRENNÉ travaille les formes et les matières en portant une attention particulière aux attentes des chefs, tant esthétiques que dans l'usage. Pour faire de la table un moment dédié aux plaisirs gastronomiques, du plus simple au plus élaboré, DEGRENNÉ imagine des collections uniques qui incarnent l'excellence et qui peuvent être associées entre elles. En jouant sur les combinaisons, les contrastes, les formes, les couleurs et les matières, chaque met trouve harmonieusement sa place à table, avec élégance et sobriété. Matières nobles, lignes épurées, épousez tous les savoir-faire DEGRENNÉ lorsque vous dressez votre table.

DEGRENNÉ develops shapes and materials, while paying careful attention to chefs' practical usage and aesthetic requirements. DEGRENNÉ designs unique collections that are the very embodiment of excellence and can also be combined, in order to make dining a moment of culinary pleasure, from the simplest to the most elaborate pleasures. Each dish harmoniously finds its rightful place on the table, with simplicity and elegance, thanks to the combinations, contrasts, shapes, colours and materials employed by DEGRENNÉ. Capitalize on DEGRENNÉ's extensive expertise when setting your table : we offer sleek lines and the finest materials.





# PORCELAINE DE LIMOGES ET EXCELLENCE

Limoges Porcelain and Excellence



Alliez élégance et sobriété grâce à des matières nobles et des formes aux lignes épurées. D'une blancheur et d'une opalescence remarquables, **la Porcelaine de Limoges** est symbole d'excellence et de pureté.

Combine elegance and simplicity by harnessing the finest materials and sleek lines. Stunning white and milkily iridescent **Limoges Porcelain** is the epitome of excellence and purity.



Découvrez les coulisses de notre Manufacture à Limoges  
Discover our factory in Limoges





**ASSIETTE PLATE 227822**  
 ROUND EXT : 32 CM - 12 IN<sup>5/8</sup>  
 DINNER PLATE INT : 19,5 CM - 7 IN<sup>11/16</sup>  
 W/WIDE RIM

**227823**  
 EXT : 28 CM - 11 IN  
 INT : 17 CM - 6 IN<sup>11/16</sup>

**227824**  
 EXT : 24 CM - 9 IN<sup>7/16</sup>  
 INT : 15 CM - 5 IN<sup>7/8</sup>



Compatible avec les assiettes cocottes  
 Compatible with the shallow plate/cups

P 138-139



**CLOCHE VERRE BOROSILICATE**  
 DOME GLASS  
 COVER **204043**

17X9 CM  
 6 IN<sup>11/16</sup> X 3 IN<sup>9/16</sup>

**BOUCHON PORCELAINE**  
 PORCELAIN LID  
**206504**  
 5,2 CM - 2 IN<sup>1/16</sup>



**ASSIETTE 227826**  
**GOURMET** EXT : 30 CM - 11 IN<sup>13/16</sup>  
 ROUND INT : 14 CM - 5 IN<sup>1/2</sup>  
 SHALLOW BOWL

W/WIDE RIM **227827**  
 EXT : 27,9 CM - 10 IN<sup>15/16</sup>  
 INT : 11,5 CM - 4 IN<sup>1/2</sup>



Compatible avec les bols cocottes  
 Compatible with the deep plate/cups

P 138-139

Compatible avec les bols biseautés cocottes  
 Compatible with the slanted plate/cups

P 138-139



**CLOCHE INOX 182614**  
 DOME COVER 24 CM - Ø 9 IN<sup>7/16</sup>  
 STAINLESS STEEL

**182301**  
 14,8 CM - Ø 5 IN<sup>13/16</sup>



**ASSIETTE À PAIN 227825**  
 ROUND BREAD EXT : 14 CM - 5 IN<sup>1/2</sup>  
 & BUTTER PLATE INT : 9,5 CM - 3 IN<sup>3/4</sup>  
 W/WIDE RIM

# COLLECTION L

---

Finedining

Haute Porcelaine de Limoges  
High Limoges Porcelain





**ASSIETTE CREUSE 232576**  
**CALOTTE** 18,5 CM  
 ROUND 7 IN<sup>5/16</sup>  
 CEREAL PLATE



**PLAT À TARTE 227839**  
 PIE/PIZZA 31,5 CM  
 PLATE, 12 IN<sup>3/8</sup>  
 FLAT



**PLAT ROND 227840**  
**CREUX** 30,5 CM  
 ROUND 12 IN  
 DEEP DISH



**PLAT OVALE 227837**  
 OVAL DISH 36,5 X 26,5 CM  
 14 IN<sup>3/8</sup> X 10 IN<sup>7/16</sup>



**PLAT À CAKE 227838**  
**RECTANGULAIRE** 37 X 15 CM  
 RECTANGULAR 14 IN<sup>9/16</sup> X 5 IN<sup>7/8</sup>  
 DISH CAKE



**SALADIER 227841**  
 SALAD BOWL 25 CM - 9 IN<sup>13/16</sup>



**VERSEUSE 245885**  
**MULTIPLE** 13 CM - 4 IN<sup>3/8</sup>  
 SAUCE JUG



**COUPELLE 227842**  
 SMALL BOWL 13,5 CM - 5 IN<sup>5/16</sup>



**MUG 247590 NEW**  
 MUG 30 CL - 10 OZ<sup>1/8</sup>



**TASSE ESPRESSO 227828**  
 DEMITASSE CUP 10 CL - 3 OZ<sup>3/8</sup> - 5,7 CM - 2 IN<sup>1/4</sup>



**TASSE LUNGO 227829**  
 COFFEE/TEA CUP 25 CL - 8 OZ<sup>7/16</sup> - 8,5 CM - 3 IN<sup>3/8</sup>

**SOUCOUBE ESPRESSO 227831**  
 DEMITASSE SAUCER 12,6 CM - Ø 4 IN<sup>5/16</sup>

**SOUCOUBE LUNGO 227832**  
 COFFEE/TEA SAUCER 15,8 CM - Ø 6 IN<sup>1/4</sup>



**THÉIÈRE 227834**  
 TEA POT 1L - 33 OZ<sup>13/16</sup>  
 H 15,7 CM - Ø 12,4 CM  
 H 6 IN<sup>7/8</sup> - Ø 4 IN<sup>7/8</sup>



**SUCRIER 227836**  
 SUGAR BOWL 30 CL - 10 OZ<sup>1/8</sup>  
 H 10,8 CM - Ø 9,2 CM  
 H 4 IN<sup>1/4</sup> - Ø 3 IN<sup>5/8</sup>



**CRÉMIER 227835**  
 CREAM JUG 16 CL - 5 OZ<sup>7/16</sup>  
 H 8,5 CM - Ø 6,7 CM  
 H 3 IN<sup>3/8</sup> - Ø 2 IN<sup>5/8</sup>



# COLLECTION L

Finedining  
Haute Porcelaine de Limoges  
High Limoges Porcelain



DEGRENNE  
LA MANUFACTURE  
PORCELAINE DE LIMOGES  
MADE IN FRANCE



BLANC  
WHITE



**ASSIETTE PLATE 237398**  
ROUND EXT : 32 CM - 12 IN<sup>5/8</sup>  
DINNER PLATE INT : 19,5 CM - 7 IN<sup>11/16</sup>  
W/WIDE RIM

**237399**  
EXT : 28 CM - 11 IN  
INT : 17 CM - 6 IN<sup>11/16</sup>

**237400**  
EXT : 24 CM - 9 IN<sup>7/16</sup>  
INT : 15 CM - 5 IN<sup>7/8</sup>



Compatible with the assiettes cocottes  
Compatible with the shallow plate/cups

P 138-139 ●●●●●●●●



**CLOCHE VERRE BOROSILICATE**  
DOME GLASS  
COVER **204043**  
17X9 CM  
6 IN<sup>11/16</sup> X 3 IN<sup>9/16</sup>

**BOUCHON PORCELAINE**  
PORCELAIN LID  
**206504**  
5,2 CM - 2 IN<sup>1/16</sup>



**ASSIETTE GOURMET 237402**  
ROUND EXT : 30 CM - 11 IN<sup>13/16</sup>  
SHALLOW BOWL INT : 14 CM - 5 IN<sup>1/2</sup>  
W/WIDE RIM

**237403**  
EXT : 27,9 CM - 11 IN  
INT : 11,5 CM - 4 IN<sup>1/2</sup>



Compatible with the bols cocottes  
Compatible with the deep plate/cups

P 138-139 ●●●●●●●●

Compatible with the bols biseautés cocottes  
Compatible with the slanted plate/cups

P 138-139 ●●●●●●●●



**CLOCHE INOX**  
DOME STAINLESS STEEL  
COVER **182614**  
24 CM - Ø 9 IN<sup>7/16</sup>

**182301**  
14,8 CM - Ø 5 IN<sup>13/16</sup>



**ASSIETTE À PAIN 237401**  
ROUND BREAD EXT : 14 CM - 5 IN<sup>1/2</sup>  
& BUTTER PLATE INT : 9,5 CM - 3 IN<sup>3/4</sup>  
W/WIDE RIM



**TASSE 227828**  
**ESPRESSO** 10 CL - 3 OZ<sup>3/8</sup>  
DEMITASSE CUP 5,7 CM - 2 IN<sup>1/4</sup>

**SOUCOUPE 237404**  
**ESPRESSO** 12,6 CM  
DEMITASSE Ø 4 IN<sup>5/16</sup>  
SAUCER



**TASSE 227829**  
**LUNGO** 25 CL - 8 OZ<sup>7/16</sup>  
COFFEE/TEA CUP 8,5 CM - 3 IN<sup>3/8</sup>

**SOUCOUPE 237405**  
**LUNGO** 15,8 CM - Ø 6 IN<sup>1/4</sup>  
COFFEE/TEA SAUCER



# COLLECTION L COUTURE

Finedining

Haute Porcelaine de Limoges  
High Limoges Porcelain



MADE IN FRANCE



BLANC  
WHITE

NOIR  
BLACK



**ASSIETTE PLATE 227843**

ROUND EXT : 32 CM - 12 IN<sup>5/8</sup>  
DINNER PLATE INT : 19,5 CM - 7 IN<sup>11/16</sup>  
W/WIDE RIM

**227844**

EXT : 28 CM - 11 IN  
INT : 17 CM - 6 IN<sup>11/16</sup>

**227845**

EXT : 24 CM - 9 IN<sup>7/16</sup>  
INT : 15 CM - 5 IN<sup>7/8</sup>

**245599**

EXT : 32 CM - 12 IN<sup>5/8</sup>  
INT : 19,5 CM - 7 IN<sup>11/16</sup>

**245601**

EXT : 28 CM - 11 IN  
INT : 17 CM - 6 IN<sup>11/16</sup>

**245603**

EXT : 24 CM - 9 IN<sup>7/16</sup>  
INT : 15 CM - 5 IN<sup>7/8</sup>

Compatible avec les assiettes cocottes  
Compatible with the shallow plate/cups

P138-139

**CLOCHE VERRE BOROSILICATE**

DOME GLASS  
COVER **204043**  
17X9 CM  
6 IN<sup>11/16</sup> X 3 IN<sup>9/16</sup>

**BOUCHON PORCELAINE**

PORCELAIN LID  
**206504**  
5,2 CM - 2 IN<sup>1/16</sup>



**ASSIETTE 227847**

**GOURMET** EXT : 30 CM - 11 IN<sup>13/16</sup>  
ROUND INT : 14 CM - 5 IN<sup>1/2</sup>  
SHALLOW BOWL  
W/WIDE RIM

**227848**

EXT : 27,9 CM - 11 IN  
INT : 11,5 CM - 4 IN<sup>1/2</sup>

**245607**

EXT : 30 CM - 11 IN<sup>13/16</sup>  
INT : 14 CM - 5 IN<sup>1/2</sup>

Compatible avec les bols cocottes  
Compatible with the deep plate/cups

P138-139

**CLOCHE INOX**

DOME STAINLESS STEEL  
COVER **182614**  
24 CM - Ø 9 IN<sup>7/16</sup>

**182301**

14,8 CM - Ø 5 IN<sup>13/16</sup>

Compatible avec les bols biseautés cocottes  
Compatible with the slanted plate/cups

P138-139



**ASSIETTE À PAIN 227846**

ROUND BREAD EXT : 14 CM - 5 IN<sup>1/2</sup>  
& BUTTER PLATE INT : 9,5 CM - 3 IN<sup>3/4</sup>  
W/WIDE RIM

**TASSE 227828**

**ESPRESSO** 10 CL - 3 OZ<sup>3/8</sup>  
DEMITASSE CUP 5,7 CM - 2 IN<sup>1/4</sup>

**SOUCOUPE 227849**

**ESPRESSO** 12,6 CM  
DEMITASSE Ø 4 IN<sup>15/16</sup>  
SAUCER

**TASSE 227829**

**LUNGO** 25 CL - 8 OZ<sup>7/16</sup>  
COFFEE/TEA CUP 8,5 CM - 3 IN<sup>3/8</sup>

**SOUCOUPE 227850**

**LUNGO** 15,8 CM - Ø 6 IN<sup>1/4</sup>  
COFFEE/TEA  
SAUCER





# COLLECTION L FRAGMENT

Finedining

Haute Porcelaine de Limoges  
High Limoges Porcelain





**ASSIETTE PLATE 233922**  
 ROUND EXT : 32 CM - 12 IN<sup>5/8</sup>  
 DINNER PLATE INT : 19,5 CM - 7 IN<sup>11/16</sup>  
 W/WIDE RIM

**233923**  
 EXT : 28 CM - 11 IN  
 INT : 17 CM - 6 IN<sup>11/16</sup>

**233924**  
 EXT : 24 CM - 9 IN<sup>7/16</sup>  
 INT : 15 CM - 5 IN<sup>7/8</sup>



Compatible avec les assiettes cocottes  
 Compatible with the shallow plate/cups

P138-139



**CLOCHE VERRE BOROSILICATE**  
 DOME GLASS  
 COVER **204043**

17X9 CM  
 6 IN<sup>11/16</sup> X 3 IN<sup>9/16</sup>

**BOUCHON PORCELAINE**  
 PORCELAIN LID  
**206504**  
 5,2 CM - 2 IN<sup>1/16</sup>



**ASSIETTE 233926**  
**GOURMET** EXT : 30 CM - 11 IN<sup>13/16</sup>  
 ROUND INT : 14 CM - 5 IN<sup>1/2</sup>  
 SHALLOW BOWL

**233927**  
 EXT : 27,9 CM - 11 IN  
 INT : 11,5 CM - 4 IN<sup>1/2</sup>  
 W/WIDE RIM



Compatible avec les bols cocottes  
 Compatible with the deep plate/cups

P138-139

Compatible avec les bols biseautés cocottes  
 Compatible with the slanted plate/cups

P138-139



**CLOCHE INOX**  
 DOME STAINLESS STEEL  
 COVER **182614**

24 CM - Ø 9 IN<sup>7/16</sup>

**182301**  
 14,8 CM - Ø 5 IN<sup>13/16</sup>



**ASSIETTE À PAIN 233925**  
 ROUND BREAD EXT : 14 CM - 5 IN<sup>1/2</sup>  
 & BUTTER PLATE INT : 9,5 CM - 3 IN<sup>3/4</sup>  
 W/WIDE RIM



**TASSE 227828**  
**ESPRESSO** 10 CL - 3 OZ<sup>3/8</sup>  
 DEMITASSE CUP 5,7 CM - 2 IN<sup>1/4</sup>

**SOUCOUE 233928**  
**ESPRESSO** 12,6 CM  
 DEMITASSE Ø 4 IN<sup>15/16</sup>  
 SAUCER



**TASSE 227829**  
**LUNGO** 25 CL - 8 OZ<sup>7/16</sup>  
 COFFEE/TEA CUP 8,5 CM - 3 IN<sup>3/8</sup>

**SOUCOUE 233929**  
**LUNGO** 15,8 CM - Ø 6 IN<sup>1/4</sup>  
 COFFEE/TEA  
 SAUCER



# COLLECTION L PERLES DE ROSÉE

---

Finedining

Haute Porcelaine de Limoges  
High Limoges Porcelain



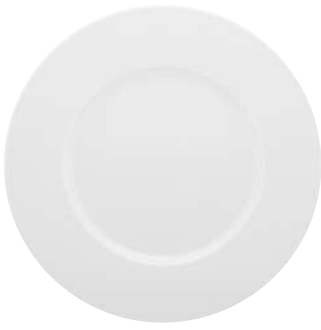

**ASSIETTE PLATE 234605**  
DINNER PLATE EXT : 32 CM - 12 IN<sup>5/8</sup>  
INT : 19 CM - 7 IN<sup>1/2</sup>

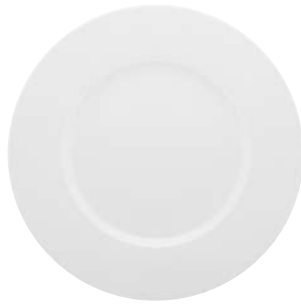

**234612**  
EXT : 30 CM - 11 IN<sup>13/16</sup>  
INT : 18 CM - 7 IN<sup>1/16</sup>



**234607**  
EXT : 26,5 CM - 10 IN<sup>7/16</sup>  
INT : 17 CM - 6 IN<sup>11/16</sup>



**234608**  
EXT : 21,5 CM - 8 IN<sup>7/16</sup>  
INT : 13 CM - 5 IN<sup>1/8</sup>



**234603**  
EXT : 16 CM - 6 IN<sup>5/16</sup>  
INT : 10 CM - 3 IN<sup>15/16</sup>



**ASSIETTE CREUSE 234610**  
**BORD À AILE** EXT : 22,5 CM - 8 IN<sup>7/8</sup>  
ROUND DEEP PLATE INT : 13 CM - 5 IN<sup>1/8</sup>



**ASSIETTE CREUSE 234609**  
**CALOTTE** EXT : 19 CM - 7 IN<sup>1/2</sup>  
CEREAL PLATE INT : 12 CM - 4 IN<sup>3/4</sup>



**BOL À SALADE 234604**  
**AVEC BORD À AILE** 17,5 CM - 6 IN<sup>7/8</sup>  
SALAD BOWL WITH RIM



**PLAT OVALE 234606**  
OVAL DISH 36,5 X 26,5 CM - 14 IN<sup>3/8</sup> X 10 IN<sup>7/16</sup>

# ECLIPSE

Alldaydining

Porcelaine  
Porcelain

  
MADE IN FRANCE



GALON OR  
GOLD



**ASSIETTE PLATE 241089**  
ROUND DINNER PLATE 32 CM - 12 IN<sup>5/8</sup>

**241090**  
26,5 CM - 10 IN<sup>7/16</sup>

**241091**  
21,5 CM - 8 IN<sup>7/16</sup>



**PLAT OVALE 241095**  
OVAL DISH 36,5 X 26,5 CM  
14 IN<sup>3/8</sup> X 10 IN<sup>7/16</sup>



**PLAT ROND PLAT 241096**  
ROUND CAKE/  
PIE DISH 31,5 CM - 12 IN<sup>3/8</sup>



**ASSIETTE À PAIN 227886**  
ROUND BREAD PLATE 14 CM - 5 IN<sup>1/2</sup>



**ASSIETTE CREUSE 241092**  
**CALOTTE RONDE** 19 CM - 7 IN<sup>1/2</sup>  
ROUND  
CEREAL PLATE



**SALADIER 241098**  
SALAD BOWL 26 CM - 10 IN<sup>1/4</sup>



**ASSIETTE CREUSE 241097**  
**À AILE RONDE** 22,5 CM - 8 IN<sup>7/8</sup>  
ROUND  
CEREAL PLATE



**COUPELLE 241099**  
ROUND 13,5 CM - 5 IN<sup>5/16</sup>  
SMALL BOWL



**TASSE À CAFÉ 241093**  
COFFEE CUP 10 CL - 3 OZ<sup>3/8</sup>



**TASSE À THÉ 247598**  
COFFEE/TEA CUP 25 CL - 8 OZ<sup>7/16</sup>



**TASSE DÉJEUNER 241102**  
BREAKFAST CUP 40 CL - 13 OZ<sup>1/2</sup>

**SOUCOUBE À CAFÉ 241094**  
COFFEE SAUCER 12,5 CM - Ø 4 IN<sup>15/16</sup>

**SOUCOUBE À THÉ 241105**  
COFFEE/TEA SAUCER 15 CM - Ø 5 IN<sup>7/8</sup>

**SOUCOUBE DÉJEUNER 241103**  
BREAKFAST SAUCER 19 CM - 7 IN<sup>1/2</sup>



**THÉIÈRE 241100**  
COFFEE/TEA POT 1L - 33 OZ<sup>13/16</sup>



**SUCRIER 241101**  
SUGAR BOWL 15 CL - 5 OZ<sup>1/16</sup>



# GALON OR

---

Finedining  
Haute Porcelaine de Limoges  
High Limoges Porcelain



GALON PLATINE  
PLATINIUM



**ASSIETTE PLATE 190054**  
ROUND DINNER PLATE 32 CM - 12 IN<sup>5/8</sup>

**190050**  
26,5 CM - 10 IN<sup>7/16</sup>

**190051**  
21,5 CM - 8 IN<sup>7/16</sup>



**PLAT OVALE 190069**  
OVAL DISH 36,5 X 26,5 CM  
14 IN<sup>3/8</sup> X 10 IN<sup>7/16</sup>



**PLAT ROND PLAT 190068**  
ROUND CAKE/ 31,5 CM - 12 IN<sup>3/8</sup>  
PIE DISH



**ASSIETTE CREUSE 190052**  
**CALOTTE RONDE** 19 CM - 7 IN<sup>1/2</sup>  
ROUND  
CEREAL PLATE



**SALADIER 190071**  
SALAD BOWL 26 CM - 10 IN<sup>1/4</sup>



**ASSIETTE CREUSE 190053**  
**À AILE RONDE** 22,5 CM - 8 IN<sup>7/8</sup>  
ROUND  
CEREAL PLATE



**COUPELLE 190070**  
ROUND 13,5 CM - 5 IN<sup>5/16</sup>  
SMALL BOWL



**TASSE À CAFÉ 203238**  
COFFEE CUP 10 CL - 3 OZ<sup>3/8</sup>

**SOUCOUPE À CAFÉ 203239**  
COFFEE SAUCER 12,5 CM - Ø 4 IN<sup>15/16</sup>



**TASSE À THÉ 247600**  
COFFEE/TEA CUP 25 CL - 8 OZ<sup>7/16</sup>

**SOUCOUPE À THÉ 203241**  
COFFEE/TEA SAUCER 15 CM - Ø 5 IN<sup>7/8</sup>



**TASSE DÉJEUNER 203242**  
BREAKFAST CUP 40 CL - 13 OZ<sup>1/2</sup>

**SOUCOUPE DÉJEUNER 203243**  
BREAKFAST SAUCER 19 CM - 7 IN<sup>1/2</sup>



**THÉIÈRE 203245**  
COFFEE/TEA POT 1 L - 33 OZ<sup>13/16</sup>



**SUCRIER 203250**  
SUGAR BOWL 15 CL - 5 OZ<sup>1/16</sup>





# GALON PLATINE

Finedining

Haute Porcelaine de Limoges  
High Limoges Porcelain





**ASSIETTE PLATE 247158 NEW**  
 ROUND 29,5 CM - 11 IN<sup>5/8</sup>  
 DINNER PLATE



**ASSIETTE PLATE 247157**  
 ROUND 26 CM - 10 IN<sup>1/4</sup>  
 DINNER PLATE



**ASSIETTE DESSERT 247163**  
 ROUND 21,5 CM - 8 IN<sup>7/16</sup>  
 DESSERT PLATE



**ASSIETTE À PAIN 247160 NEW**  
 ROUND BREAD & BUTTER PLATE  
 14 CM - 5 IN<sup>1/2</sup>



**ASSIETTE COUPE 247164**  
**RONDE** 19 CM - 7 IN<sup>1/2</sup>  
 SHALLOW COUPE BOL,  
 MEDIUM



**GRAND PLAT CREUX / 247159 NEW**  
**ASSIETTE À PÂTES** 31,5 CM  
**RONDE** 12 IN<sup>3/16</sup>  
 SERVING DISH/  
 ROUND PASTA PLATE

# REMINISCENCE

---

Alldaydining  
Haute Porcelaine de Limoges  
High Limoges Porcelain



SD ONE BLANC  
WHITE



**ASSIETTE PLATE 241052**  
ROUND 32 CM - 12 IN<sup>5/8</sup>  
DINNER PLATE



**241050**  
27 CM - 10 IN<sup>5/8</sup>



**241051**  
21,5 CM - 8 IN<sup>7/16</sup>



**ASSIETTE À PAIN 242916**  
ROUND 14 CM - 5 IN<sup>1/2</sup>  
BREAD PLATE



**ASSIETTE COUPE 241048**  
SHALLOW COUPE 25 CM - 9 IN<sup>13/16</sup>  
BOWL, LARGE



**241049**  
19 CM - 7 IN<sup>1/2</sup>



**BOL 241143**  
BOWL 14 CM - 5 IN<sup>1/2</sup>  
55 CL - 18 OZ<sup>5/8</sup>



**VERSEUSE 245885**  
MULTIPLE 13 CM - 4 IN<sup>3/8</sup>  
SAUCE JUG



**TASSE ESPRESSO 242910**  
ESPRESSO CUP H 6,3 CM - 2 IN<sup>1/2</sup>  
Ø 6 CM - 2 IN<sup>3/8</sup>  
7 CL - 2 OZ<sup>3/8</sup>



**TASSE THÉ/CAFÉ 242912**  
TEA/COFFEE CUP H 8 CM - 3 IN<sup>1/8</sup>  
Ø 7,8 CM - 3 IN<sup>1/16</sup>  
15 CL - 5 OZ<sup>1/16</sup>

**SOUCOUPE 242914**  
SAUCER Ø 14 CM - 5 IN<sup>1/2</sup>

**SOUCOUPE 242914**  
SAUCER Ø 14 CM - 5 IN<sup>1/2</sup>

SD ONE OR  
GOLD



**242547**  
32 CM - 12 IN<sup>5/8</sup>



**241053**  
27 CM - 10 IN<sup>5/8</sup>



**241054**  
21,5 CM - 8 IN<sup>7/16</sup>



# SD ONE

---

Finedining  
Haute Porcelaine de Limoges  
High Limoges Porcelain



SUPERNATURE  
WHITE



**ASSIETTE PLATE 242906**  
ROUND DINNER PLATE 32 CM - 12 IN<sup>5/8</sup>



**242330**  
27 CM - 10 IN<sup>5/8</sup>



**242331**  
21,5 CM - 8 IN<sup>7/16</sup>



**ASSIETTE 242907**  
**À PAIN** 14 CM - 5 IN<sup>1/2</sup>  
ROUND  
BREAD PLATE

Compatible avec l'assiette coupe  
de la collection SD ONE  
Compatible with the plate  
of SD ONE collection



**ASSIETTE COUPE 241048**  
SHALLOW COUPE 25 CM - 9 IN<sup>13/16</sup>  
BOWL, LARGE



**241049**  
19 CM - 7 IN<sup>1/2</sup>

SUPERNATURE OR  
GOLD



**ASSIETTE 244121**  
**PLATE** 27 CM - 10 IN<sup>5/8</sup>  
ROUND  
DINNER PLATE



**ASSIETTE 244120**  
**DESSERT** 21,5 CM - 8 IN<sup>7/16</sup>  
ROUND  
DESSERT PLATE



# SUPERNATURE

Finedining  
Haute Porcelaine de Limoges  
High Limoges Porcelain



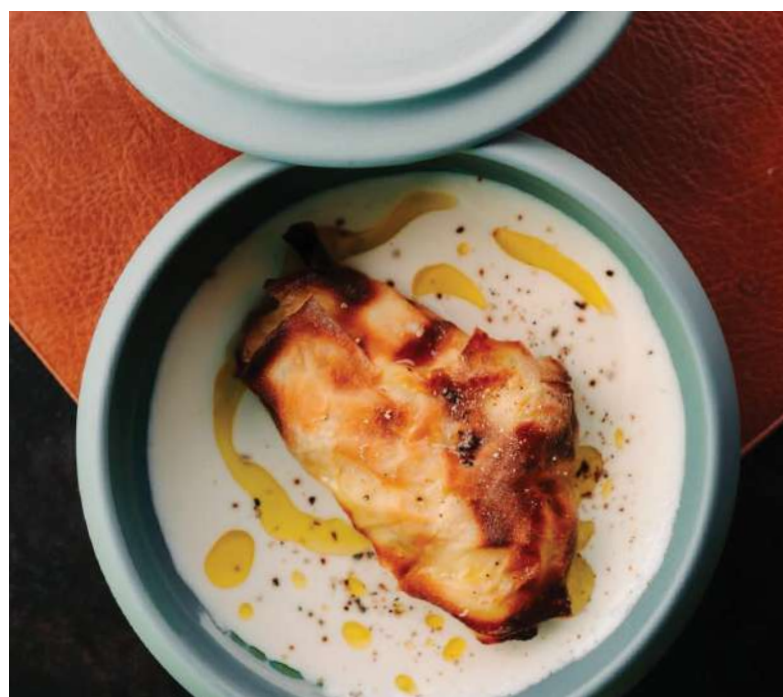

L'abus d'alcool est dangereux pour la santé  
Alcohol abuse is dangerous for your health



# LA CÉRAMIQUE

Ceramic

En porcelaine ou en grès, des iconiques COCOTTES jusqu'à nos assiettes COURONNE au décor en relief irisé posé à la main, nos collections de céramique mettent en avant les savoir-faire de notre Maison et se déclinent en une multitude de formats et de couleurs et s'adaptent à vos besoins pour dresser vos tables du quotidien ou des grandes occasions.

In porcelain or stoneware, from the iconic CUPS to our COURONNE plates, with hand-placed iridescent relief decoration. Our ceramic collections highlight the know-how of our House and are available in a multitude of formats and colors and adapt to your needs to set your tables for everyday life or special occasions.



PIERRE DE LUNE  
MOONSTONE  
Porcelaine - Porcelain



DUNE  
BEIGE DUNE  
Grès - Stoneware



BLEU DE ROCHE  
BLUE STONE  
Grès - Stoneware



ARGILE VERTE  
GREEN CLAY  
Grès - Stoneware



ONYX  
BLACK ONYX  
Grès - Stoneware

# BAHIA

---

Alldaydining  
Porcelaine - Grès  
Porcelain - Stoneware

MADE IN EUROPE 



PIERRE DE LUNE  
MOONSTONE  
Porcelaine - Porcelain



**ASSIETTE** **239318**  
**PLATE** EXT : 29 CM - 11 IN<sup>7/16</sup>  
ROUND INT : 25,5 CM - 10 IN<sup>1/16</sup>  
DINNER PLATE

**239317**  
EXT : 26 CM - 10 IN<sup>1/4</sup>  
INT : 22 CM - 8 IN<sup>11/16</sup>

**239316**  
EXT : 23 CM - 9 IN<sup>1/16</sup>  
INT : 19,5 CM - 7 IN<sup>11/16</sup>



**ASSIETTE** **239315**  
**À PAIN** EXT : 14 CM - 5 IN<sup>1/2</sup>  
ROUND INT : 10 CM - 3 IN<sup>15/16</sup>  
BREAD PLATE



**ASSIETTE** **239319**  
**CREUSE** 45 CL - 15 OZ<sup>3/16</sup>  
ROUND EXT : 20 CM - 7 IN<sup>7/8</sup>  
CEREAL PLATE INT : 16,5 CM - 6 IN<sup>1/2</sup>



**ASSIETTE** **209384**  
**COUVERCLE** 12,5 CM - 4 IN<sup>15/16</sup>  
PLATE/CUP



**BOL COCOTTE** **209720**  
DEEP PLATE/CUP 50 CL - 16 OZ<sup>15/16</sup>  
14 CM - 5 IN<sup>1/2</sup>



**BOL** **211893** **211892**  
**BISEAUTÉ** 30 CL - 10 OZ<sup>1/8</sup> 7 CL - 2 OZ<sup>3/8</sup>  
**COCOTTE** 12 CM - 4 IN<sup>3/4</sup> 7,3 CM - 2 IN<sup>7/8</sup>  
MINI CUP



**ASSIETTE** **239321**  
**GOURMET** GRAND BASSIN  
ROUND W/WIDE ROUND RIM  
GOURMET EXT : 26 CM - 10 IN<sup>1/4</sup>  
PLATE INT : 14 CM - 5 IN<sup>1/2</sup>

**239320**  
PETIT BASSIN  
W/WIDE ROUND RIM  
EXT : 23 CM - 9 IN<sup>1/16</sup>  
INT : 11,5 CM - 4 IN<sup>1/2</sup>

DUNE  
BEIGE DUNE  
Grés - Stoneware



**230921**  
EXT : 29 CM - 11 IN<sup>7/16</sup>  
INT : 25,5 CM - 10 IN<sup>1/16</sup>

**230920**  
EXT : 26 CM - 10 IN<sup>1/4</sup>  
INT : 22 CM - 8 IN<sup>11/16</sup>

**230919**  
EXT : 23 CM - 9 IN<sup>1/16</sup>  
INT : 19,5 CM - 7 IN<sup>11/16</sup>



**230918**  
EXT : 14 CM - 5 IN<sup>1/2</sup>  
INT : 10 CM - 3 IN<sup>15/16</sup>



**230922**  
45 CL - 15 OZ<sup>3/16</sup>  
EXT : 20 CM - 7 IN<sup>7/8</sup>  
INT : 16,5 CM - 6 IN<sup>1/2</sup>



**230928**  
12,5 CM - 4 IN<sup>15/16</sup>



**230927** **247271 NEW**  
50 CL - 16 OZ<sup>15/16</sup> (émaillée - enameled)  
14 CM - 5 IN<sup>1/2</sup>



**230926** **230925**  
30 CL - 10 OZ<sup>1/8</sup> 7 CL - 2 OZ<sup>3/8</sup>  
12 CM - 4 IN<sup>3/4</sup> 7,3 CM - 2 IN<sup>7/8</sup>



**230924**  
GRAND BASSIN  
W/WIDE ROUND RIM  
EXT : 26 CM - 10 IN<sup>1/4</sup>  
INT : 14 CM - 5 IN<sup>1/2</sup>

**230923**  
PETIT BASSIN  
W/WIDE ROUND RIM  
EXT : 23 CM - 9 IN<sup>1/16</sup>  
INT : 11,5 CM - 4 IN<sup>1/2</sup>

BLEU DE ROCHE  
BLUE STONE  
Grés - Stoneware



**230966**  
EXT : 29 CM - 11 IN<sup>7/16</sup>  
INT : 25,5 CM - 10 IN<sup>1/16</sup>

**230965**  
EXT : 26 CM - 10 IN<sup>1/4</sup>  
INT : 22 CM - 8 IN<sup>11/16</sup>

**230964**  
EXT : 23 CM - 9 IN<sup>1/16</sup>  
INT : 19,5 CM - 7 IN<sup>11/16</sup>



**230963**  
EXT : 14 CM - 5 IN<sup>1/2</sup>  
INT : 10 CM - 3 IN<sup>15/16</sup>



**230967**  
45 CL - 15 OZ<sup>3/16</sup>  
EXT : 20 CM - 7 IN<sup>7/8</sup>  
INT : 16,5 CM - 6 IN<sup>1/2</sup>



**230973**  
12,5 CM - 4 IN<sup>15/16</sup>



**230972** **247268 NEW**  
50 CL - 16 OZ<sup>15/16</sup> (émaillée-enameled)  
14 CM - 5 IN<sup>1/2</sup>



**230971** **230970**  
30 CL - 10 OZ<sup>1/8</sup> 7 CL - 2 OZ<sup>3/8</sup>  
12 CM - 4 IN<sup>3/4</sup> 7,3 CM - 2 IN<sup>7/8</sup>



**230969**  
GRAND BASSIN  
W/WIDE ROUND RIM  
EXT : 26 CM - 10 IN<sup>1/4</sup>  
INT : 14 CM - 5 IN<sup>1/2</sup>

**230968**  
PETIT BASSIN  
W/WIDE ROUND RIM  
EXT : 23 CM - 9 IN<sup>1/16</sup>  
INT : 11,5 CM - 4 IN<sup>1/2</sup>



ARGILE VERTE  
GREEN CLAY  
Grés - Stoneware



**230952**  
EXT : 29 CM - 11 IN<sup>7/16</sup>  
INT : 25,5 CM - 10 IN<sup>1/16</sup>

**230951**  
EXT : 26 CM - 10 IN<sup>1/4</sup>  
INT : 22 CM - 8 IN<sup>11/16</sup>

**230950**  
EXT : 23 CM - 9 IN<sup>1/16</sup>  
INT : 19,5 CM - 7 IN<sup>11/16</sup>



**230949**  
EXT : 14 CM - 5 IN<sup>1/2</sup>  
INT : 10 CM - 3 IN<sup>15/16</sup>



**230953**  
45 CL - 15 OZ<sup>3/16</sup>  
EXT : 20 CM - 7 IN<sup>7/8</sup>  
INT : 16,5 CM - 6 IN<sup>1/2</sup>



**230959**  
12,5 CM - 4 IN<sup>15/16</sup>



**244138**  
BI FINITION-DUAL FINISH

LIMITED STOCK



**230958**  
50 CL - 16 OZ<sup>15/16</sup>  
14 CM - 5 IN<sup>1/2</sup>



**247272 NEW**  
(émaillée - enameled)



**230957**  
30 CL - 10 OZ<sup>1/8</sup>  
12 CM - 4 IN<sup>3/4</sup>



**230956**  
7 CL - 2 OZ<sup>3/8</sup>  
7,3 CM - 2 IN<sup>7/8</sup>



**230955**  
GRAND BASSIN  
W/WIDE ROUND RIM  
EXT : 26 CM - 10 IN<sup>1/4</sup>  
INT : 14 CM - 5 IN<sup>1/2</sup>

**230954**  
PETIT BASSIN  
W/WIDE ROUND RIM  
EXT : 23 CM - 9 IN<sup>1/16</sup>  
INT : 11,5 CM - 4 IN<sup>1/2</sup>

ONYX  
BLACK ONYX  
Grés - Stoneware



**236549**  
EXT : 29 CM - 11 IN<sup>7/16</sup>  
INT : 25,5 CM - 10 IN<sup>1/16</sup>

**236548**  
EXT : 26 CM - 10 IN<sup>1/4</sup>  
INT : 22 CM - 8 IN<sup>11/16</sup>

**236547**  
EXT : 23 CM - 9 IN<sup>1/16</sup>  
INT : 19,5 CM - 7 IN<sup>11/16</sup>



**236546**  
EXT : 14 CM - 5 IN<sup>1/2</sup>  
INT : 10 CM - 3 IN<sup>15/16</sup>



**236550**  
45 CL - 15 OZ<sup>3/16</sup>  
EXT : 20 CM - 7 IN<sup>7/8</sup>  
INT : 16,5 CM - 6 IN<sup>1/2</sup>



**236556**  
12,5 CM - 4 IN<sup>15/16</sup>



**236555**  
50 CL - 16 OZ<sup>15/16</sup>  
14 CM - 5 IN<sup>1/2</sup>



**247270 NEW**  
(émaillée - enameled)



**236554**  
30 CL - 10 OZ<sup>1/8</sup>  
12 CM - 4 IN<sup>3/4</sup>



**236553**  
7 CL - 2 OZ<sup>3/8</sup>  
7,3 CM - 2 IN<sup>7/8</sup>



**236552**  
GRAND BASSIN  
W/WIDE ROUND RIM  
EXT : 26 CM - 10 IN<sup>1/4</sup>  
INT : 14 CM - 5 IN<sup>1/2</sup>

**236551**  
PETIT BASSIN  
W/WIDE ROUND RIM  
EXT : 23 CM - 9 IN<sup>1/16</sup>  
INT : 11,5 CM - 4 IN<sup>1/2</sup>



**ASSIETTE COUVERCLE**  
PLATE CUP

**BOL COCOTTE**  
DEEP PLATE/CUP

**ASSIETTE GOURMET**  
GRAND BASSIN  
ROUND GOURMET PLATE  
W/WIDE ROUND RIM



**ASSIETTE GOURMET**  
PETIT BASSIN  
ROUND GOURMET PLATE  
W/WIDE ROUND RIM

**BOL BISEAUTÉ COCOTTE**  
SLANTED PLATE/CUP



**ACCESSOIRES** ACCESSORIES

PIERRE DE LUNE  
MOONSTONE  
Porcelaine - Porcelain

DUNE  
BEIGE DUNE  
Grés - Stoneware

BLEU DE ROCHE  
BLUE STONE  
Grés - Stoneware

ONYX  
BLACK ONYX  
Grés - Stoneware

VERT ARGILE  
GREEN CLAY  
Grés - Stoneware



**SALADIER 239325**  
LARGE DEEP 28 CM - 11 IN  
PLATE/CUP



**235223**  
28 CM - 11 IN



**235222**  
28 CM - 11 IN



**240499**  
28 CM - 11 IN



**PLANCHE 242054**  
RECTANGULAIRE 35 x 21 CM  
RECTANGULAR 13 IN<sup>3/4</sup> x 8 IN<sup>1/4</sup>  
BOARD



**242056**  
35 x 21 CM  
13 IN<sup>3/4</sup> x 8 IN<sup>1/4</sup>



**242052**  
35 x 21 CM  
13 IN<sup>3/4</sup> x 8 IN<sup>1/4</sup>



**237206**  
25 X 13,5 CM  
9 IN<sup>13/16</sup> X 5 IN<sup>5/16</sup>



**234949**  
25 X 13,5 CM  
9 IN<sup>13/16</sup> X 5 IN<sup>5/16</sup>

**234948**  
25 X 13,5 CM  
9 IN<sup>13/16</sup> X 5 IN<sup>5/16</sup>

**234950**  
25 X 13,5 CM  
9 IN<sup>13/16</sup> X 5 IN<sup>5/16</sup>



**PLANCHE 242055**  
RONDE 29 CM - 11 IN<sup>7/16</sup>  
ROUND  
BOARD



**242057**  
29 CM - 11 IN<sup>7/16</sup>



**242053**  
29 CM - 11 IN<sup>7/16</sup>



**PLAT 241835**  
GRAND 31,8 x 25 x 7,4 CM  
MODÈLE 12 IN<sup>1/2</sup> x 9 IN<sup>13/16</sup> x 2 IN<sup>15/16</sup>  
LARGE DISH



**237595**  
31,8 x 25 x 7,4 CM  
12 IN<sup>1/2</sup> x 9 IN<sup>13/16</sup> x 2 IN<sup>15/16</sup>

**PLAT 241834**  
MOYEN 22,8 x 16,2 x 5,4 CM  
MODÈLE 9 IN x 6 IN<sup>3/8</sup> x 2 IN<sup>1/8</sup>  
MEDIUM DISH

**237594**  
22,8 x 16,2 x 5,4 CM  
9 IN x 6 IN<sup>3/8</sup> x 2 IN<sup>1/8</sup>

**PLAT 241833**  
PETIT 15,5 x 10,7 x 4,4 CM  
MODÈLE 6 IN<sup>7/8</sup> x 4 IN<sup>3/16</sup> x 1 IN<sup>3/4</sup>  
SMALL DISH

**237593**  
15,5 x 10,7 x 4,4 CM  
6 IN<sup>7/8</sup> x 4 IN<sup>3/16</sup> x 1 IN<sup>3/4</sup>





BLUE SHADES HALO  
BLUE SHADES HALO



CODE EXPORT

**ASSIETTE PLATE** **240242**  
ROUND DINNER PLATE EXT : 29 CM - 11 IN <sup>7/16</sup>

**240243** **239655**  
EXT : 26 CM - 10 IN <sup>1/4</sup>

**240244** **239656**  
EXT : 23 CM - 9 IN <sup>1/16</sup>

BLUE SHADES AQUARELLE  
BLUE SHADES WATERCOLOR

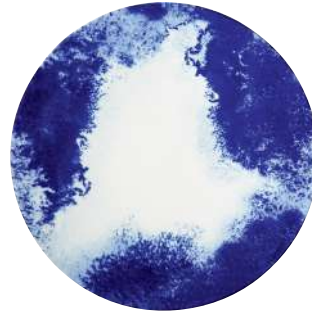

**239661**  
EXT : 26 CM - 10 IN <sup>1/4</sup>

**239662**  
EXT : 23 CM - 9 IN <sup>1/16</sup>



CODE EXPORT

**BOL COCOTTE** **239658**  
**+ ASSIETTE/COUVERCLE** 14 CM - 5 IN <sup>1/2</sup>  
DEEP PLATE/CUP + 50 CL - 16 OZ <sup>15/16</sup>  
ROUND PLATE  
CUP **+240245** **239767**  
12,5 CM - 4 IN <sup>15/16</sup>



**BOL COCOTTE** **239659**  
DEEP PLATE/CUP 17,5 CM - 6 IN <sup>7/8</sup>  
140 CL - 47 OZ <sup>5/16</sup>



**BOL BISEAUTÉ COCOTTE** **239660**  
MINI CUP 7,5 CM - 2 IN <sup>15/16</sup>  
7 CL - 2 OZ <sup>3/8</sup>



**BOL À DÉJEUNER** **239657**  
BREAKFAST BOWL 14 CM - 5 IN <sup>1/2</sup>  
55 CL - 18 OZ <sup>5/8</sup>





# BLUE SHADES

---

Alldaydining

Porcelaine

Porcelain

MADE IN EUROPE





**ASSIETTE PLATE 186770**  
**RONDE** 32,5 CM  
 ROUND 12 IN<sup>5/8</sup>  
 DINNER PLATE  
 W/WIDE RIM

---

**186765**  
 28,5 CM  
 11 IN

---

**186767**  
 22,5 CM  
 8 IN<sup>7/8</sup>



**ASSIETTE 207140**  
**À PÂTES/SOUPA** EXT : 29,5 CM - 11 IN<sup>7/16</sup>  
 ROUND SOUP/PASTA INT : 17 CM - 6 IN<sup>11/16</sup>  
 BOWL W/WIDE RIM



**ASSIETTE 207136**  
**CALOTTE OVALE** EXT : 23,5 X 20 CM  
 OVAL 9 IN<sup>1/4</sup> X 7 IN<sup>7/8</sup>  
 SHALLOW BOWL,  
 COUPE



**ASSIETTE À PAIN 187263**  
 ROUND 16 CM  
 BREAD PLATE 6 IN<sup>5/16</sup>  
 W/WIDE RIM



**ASSIETTE 246215**  
**CREUSE** 20 CM - 7 IN<sup>7/8</sup>  
 SHALLOW  
 PLATE

**NEW**



**MINI PLATEAU 159924**  
**RECTANGULAIRE** 16 X 12 CM -  
 RECTANGULAR 6 IN<sup>5/16</sup> X 4 IN<sup>3/4</sup>  
 SMALL DISH



**ASSIETTE GOURMET 204040**  
**OVALE GRAND BASSIN** EXT : 32 X 27 CM - 12 IN<sup>5/8</sup> X 10 IN<sup>5/8</sup>  
 SHALLOW BOWL INT : 14,5 CM - 5 IN<sup>5/16</sup>  
 W/WIDE OVAL RIM 27 CL - 9 OZ<sup>1/8</sup>



Compatible avec les bols cocottes  
 Compatible with the deep plate/cups



**ASSIETTE GOURMET 207138**  
**OVALE PETIT BASSIN** EXT : 30 X 26 CM - 11 IN<sup>13/16</sup> X 10 IN<sup>1/4</sup>  
 SHALLOW BOWL INT : 13,5 CM - 5 IN<sup>5/16</sup>  
 W/WIDE OVAL RIM 17 CL - 5 OZ<sup>3/4</sup>

Compatible avec les bols biseautés cocottes  
 Compatible with the slanted plate/cups



**TASSE À CAFÉ 186791**  
 DEMITASSE CUP 9 CL - 3 OZ<sup>1/16</sup>



**TASSE À THÉ 186793**  
 COFFEE/TEA CUP 15 CL - 5 OZ<sup>1/16</sup>



**TASSE DÉJEUNER 186795**  
 BREAKFAST CUP 40 CL - 13 OZ<sup>1/2</sup>

**SOUCOUPE À CAFÉ 186792**  
**OVALE** 14X12 CM  
 OVAL DEMITASSE Ø 5 IN<sup>1/2</sup> X 4 IN<sup>3/4</sup>  
 SAUCER

**SOUCOUPE À THÉ 186794**  
**OVALE** 16,5 X 14 CM  
 OVAL COFFEE/TEA Ø 6 IN<sup>1/2</sup> X 5 IN<sup>1/2</sup>  
 SAUCER

**SOUCOUPE DÉJEUNER 186796**  
**OVALE** 20X17 CM  
 OVAL BREAKFAST Ø 7 IN<sup>7/8</sup> X 6 IN<sup>11/16</sup>  
 SAUCER



BORÉAL

All day dining

Porcelaine

Porcelain

MADE IN EUROPE





**ASSIETTE PLATE 246871**  
**RONDE** 32,5 CM  
 ROUND 12 IN<sup>5/8</sup>  
 DINNER PLATE  
 W/WIDE RIM



**246874**  
 28,5 CM  
 11 IN



**246877**  
 22,5 CM  
 8 IN<sup>7/8</sup>



**CLOCHE VERRE BOROSILICATE**  
 DOME GLASS  
 COVER **204043**  
 17X9 CM  
 6 IN<sup>11/16</sup> X 3 IN<sup>9/16</sup>

**BOUCHON PORCELAINE**  
 PORCELAIN LID  
**206504**  
 5,2 CM - 2 IN<sup>1/16</sup>



**CLOCHE INOX**  
 DOME STAINLESS STEEL  
 COVER **182614**  
 24 CM - Ø 9 IN<sup>7/16</sup>

**182301**  
 14,8 CM - Ø 5 IN<sup>13/16</sup>



# BORÉAL ONDE

Finedining

Porcelaine

Porcelain

MADE IN EUROPE

NEW



BLANC  
WHITE

DORÉ  
GOLD

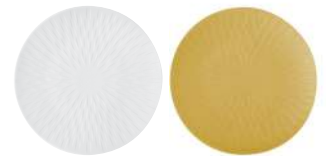
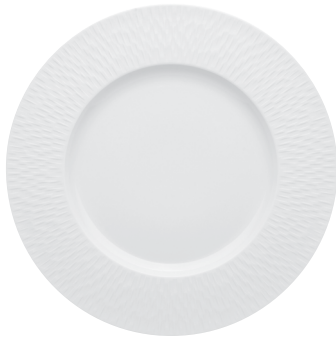

**ASSIETTE PLATE 193319**  
DINNER PLATE EXT : 32,5 CM - 12 IN<sup>5/8</sup>  
W/WIDE RIM INT : 20 CM - 7 IN<sup>7/8</sup>

225193

**193318**  
EXT : 28,5 CM - 11 IN  
INT : 18,5 CM - 7 IN<sup>5/16</sup>

225194

**193320**  
EXT : 22,5 CM - 8 IN<sup>7/8</sup>  
INT : 14,5 CM - 5 IN<sup>11/16</sup>

225195

**ASSIETTE 223954**  
À PÂTES/SOUBE EXT : 29 CM - 11 IN<sup>7/16</sup>  
ROUND SOUP/PASTA INT : 16 CM - 6 IN<sup>5/16</sup>  
BOWL W/WIDE RIM

**ASSIETTE À PAIN 202470 225196**  
ROUND BREAD EXT : 15 CM  
& BUTTER PLATE 5 IN<sup>7/8</sup>  
W/WIDE RIM



**ASSIETTE GOURMET 207769**  
OVALE GRAND BASSIN EXT : 32 X 27 CM  
SHALLOW BOWL 12 IN<sup>5/8</sup> X 10 IN<sup>5/8</sup>  
W/WIDE OVAL RIM INT : 14,5 CM - 5 IN<sup>5/16</sup>  
27 CL - 9 OZ<sup>1/8</sup>

Compatible avec les bols cocottes  
Compatible with the deep plate/cups  
P138-139

**CLOCHE INOX 182614**  
DOME STAINLESS STEEL  
COVER 24 CM - Ø 9 IN<sup>7/16</sup>

**ASSIETTE GOURMET 193324 225197**  
OVALE PETIT BASSIN EXT : 30 X 26 CM  
SHALLOW BOWL 11 IN<sup>13/16</sup> X 10 IN<sup>1/4</sup>  
W/WIDE OVAL RIM INT : 13,5 CM - 5 IN<sup>5/16</sup>  
17 CL - 5 OZ<sup>3/4</sup>

Compatible avec les bols biseautés cocottes  
Compatible with the slanted plate/cups  
P138-139

**182301**  
14,8 CM - Ø 5 IN<sup>13/16</sup>



**TASSE À CAFÉ 186791**  
DEMITASSE CUP 9 CL - 3 OZ<sup>1/16</sup>

**TASSE À THÉ 186793**  
COFFEE/TEA CUP 15 CL - 5 OZ<sup>1/16</sup>

**TASSE DÉJEUNER 186795**  
BREAKFAST CUP 40 CL - 13 OZ<sup>1/2</sup>

**SOUCOUBE 193321**  
À CAFÉ OVALE 14X12 CM  
OVAL DEMITASSE Ø 5 IN<sup>1/2</sup> X 4 IN<sup>3/4</sup>  
SAUCER

**SOUCOUBE 193322**  
À THÉ OVALE 16,5 X 14 CM  
OVAL COFFEE/TEA Ø 6 IN<sup>1/2</sup> X 5 IN<sup>1/2</sup>  
SAUCER

**SOUCOUBE 193323**  
DÉJEUNER OVALE 20X17 CM  
OVAL BREAKFAST Ø 7 IN<sup>7/8</sup> X 6 IN<sup>11/16</sup>  
SAUCER



# BORÉAL SATIN

Finedining

Porcelaine

Porcelain

MADE IN EUROPE



L'abus d'alcool est dangereux pour la santé  
Alcohol abuse is dangerous for your health

ROSÉE  
PINK



**ASSIETTE** 241267  
**PLATE** 26 CM - 10 IN<sup>1/4</sup>  
ROUND  
DINNER  
PLATE

SABLE  
SAND



**241275**  
26 CM - 10 IN<sup>1/4</sup>

LAIT  
WHITE MILK



**244749**  
26 CM - 10 IN<sup>1/4</sup>



**241268**  
20 CM - 7 IN<sup>7/8</sup>



**241276**  
20 CM - 7 IN<sup>7/8</sup>



**244751**  
20 CM - 7 IN<sup>7/8</sup>



**BOL** 241269  
**BOWL** 20 CM - 7 IN<sup>7/8</sup>  
88 CL - 29 OZ<sup>3/4</sup>



**241277**  
20 CM - 7 IN<sup>7/8</sup>  
88 CL - 29 OZ<sup>3/4</sup>



**244753**  
20 CM - 7 IN<sup>7/8</sup>  
88 CL - 29 OZ<sup>3/4</sup>



**COUPELLE** 241270  
**SMALL** 12,5 CM - 4 IN<sup>15/16</sup>  
**BOWL** 23 CL - 7 OZ<sup>3/4</sup>



**241278**  
12,5 CM - 4 IN<sup>15/16</sup>  
23 CL - 7 OZ<sup>3/4</sup>



**244755**  
12,5 CM - 4 IN<sup>15/16</sup>  
23 CL - 7 OZ<sup>3/4</sup>





BRUME

Alldaydining

Grès

Stoneware

MADE IN EUROPE



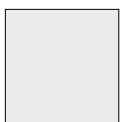

**BLANC  
WHITE**

Porcelaine - Porcelain

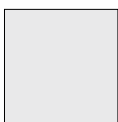

**BLANC SABLE  
SANDY WHITE**

Porcelaine - Porcelain



**ONYX  
BLACK ONYX**

Grés - Stoneware



**BLEU GOURMET  
GOURMET BLUE**

Grés - Stoneware



**ROSE NUDE  
PINK NUDE**

Grés - Stoneware



**DUNE  
BEIGE DUNE**

Grés - Stoneware



**BLEU DE ROCHE  
BLUE STONE**

Grés - Stoneware



**ARGILE VERTE  
GREEN CLAY**

Grés - Stoneware

# COCOTTES

Finedining

Porcelaine - Grès

Porcelain - Stoneware

MADE IN EUROPE



BLANC  
WHITE  
Porcelaine - Porcelain

BLANC SABLE  
SANDY WHITE  
Porcelaine - Porcelain

ONYX  
BLACK ONYX  
Grès - Stoneware

BLEU GOURMET  
GOURMET BLUE  
Grès - Stoneware

**ASSIETTE  
COCOTTE (1)**  
SHALLOW  
PLATE/CUP  
22 CM - 8 IN<sup>11/16</sup>  
100 CL - 33 OZ<sup>13/16</sup>



234342



234345



243821



234339

**ASSIETTE  
COCOTTE (2)**  
SHALLOW  
PLATE/CUP  
18 CM - 7 IN<sup>7/16</sup>  
70 CL - 23 OZ<sup>11/16</sup>



235064



235065



243830



235063

**SALADIER**  
LARGE DEEP  
PLATE/CUP  
28 CM - 11 IN  
4L - 135 OZ<sup>1/4</sup>



239325



240499

**BOL  
COCOTTE**  
DEEP PLATE/CUP  
17,5 CM - 6 IN<sup>7/8</sup>  
140 CL - 47 OZ<sup>5/16</sup>



234341



234344



243803



234338

**BOL  
COCOTTE (3)**  
DEEP PLATE/CUP  
14 CM - 5 IN<sup>1/2</sup>  
50 CL - 16 OZ<sup>15/16</sup>



209383



209720



236555

247268 **NEW**  
(émaillée-enameled)



230821



247269 **NEW**  
(émaillée-enameled)

**ASSIETTE  
COUVERCLE**  
PLATE CUP  
12,5 CM - 4 IN<sup>15/16</sup>  
18 CM - 7 IN<sup>7/16</sup>



209384

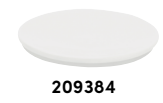

209384



236556

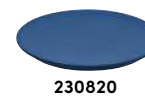

230820



245378



245378

**BOL BISEAUTÉ  
COCOTTE**  
SLANTED  
PLATE/CUP  
16 CM - 6 IN<sup>5/16</sup>  
100 CL - 33 OZ<sup>13/16</sup>



234340



234343



234337

**BOL BISEAUTÉ  
COCOTTE(4)**  
SLANTED  
PLATE/CUP  
12 CM - 4 IN<sup>3/4</sup>  
30 CL - 10 OZ<sup>1/8</sup>



186849



211893



236554



230822

**BOL BISEAUTÉ  
COCOTTE**  
MINI CUP  
7,3 CM - 2 IN<sup>7/8</sup>  
7 CL - 2 OZ<sup>3/8</sup>



211891



211892



236553



230823



(1) Compatible avec les assiettes de présentation  
Compatible with the presentation plates



(2) Compatible avec les assiettes plates 28 cm  
Compatible with the dinner plates 11 in

DUNE  
BEIGE DUNE  
Grés - Stoneware

BLEU DE ROCHE  
BLUE STONE  
Grés - Stoneware

ARGILE VERTE  
GREEN CLAY  
Grés - Stoneware

ROSE NUDE  
PINK NUDE  
Porcelaine - Porcelain

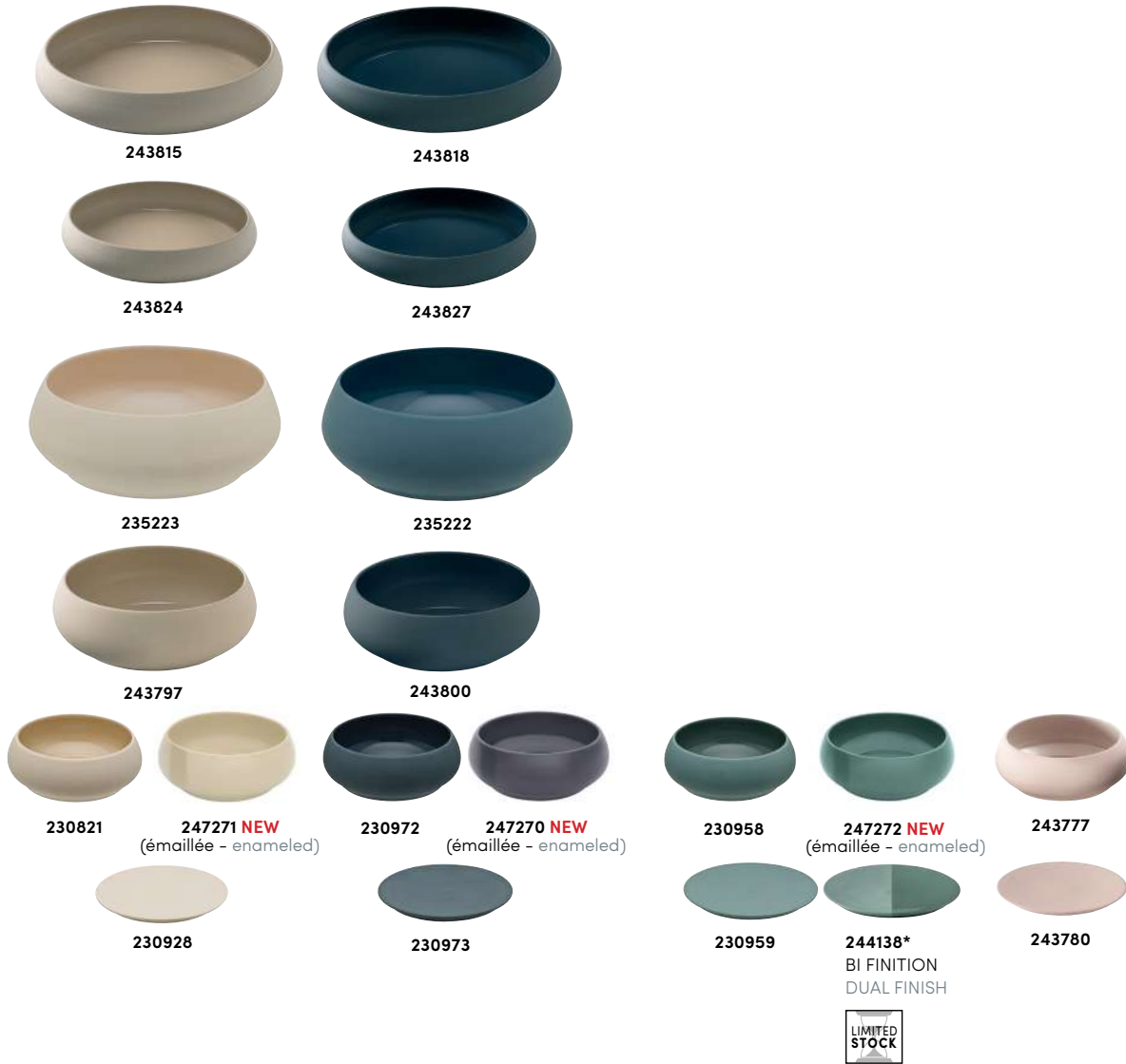

EMPILABLE - STACKABLE

\*Arrêt à épuisement des stocks  
Until stock limited



(3) Compatible avec les assiettes gourmet 30/32 cm  
Compatible with the round shallow bowls 11 in<sup>12/15</sup>/12 in<sup>5/8</sup>

(4) Compatible avec les assiettes gourmet 28/30 cm  
Compatible with the round shallow bowls 11 in/11 in<sup>13/16</sup>





**ASSIETTE 246704**  
**PLATE** 32 CM - 12 IN<sup>5/8</sup>  
 ROUND  
 DINNER  
 PLATE



**246707**  
 29 CM - 11 IN<sup>7/16</sup>



**246710**  
 26 CM - 10 IN<sup>1/4</sup>



**ASSIETTE 246713**  
**DESSERT** 20 CM  
 ROUND 7 IN<sup>7/8</sup>  
 DESSERT  
 PLATE



**ASSIETTE 246719**  
**COUPE** 24 CM - 9 IN<sup>7/16</sup>  
 SHALLOW COUPE  
 BOWL, LARGE



**ASSIETTE 246716**  
**À PAIN** 15 CM  
 BREAD 5 IN<sup>7/8</sup>  
 BUTTER  
 PLATE



**CAFÉTERIE - COFFEEWARE**  
 P.178



**PLAT OVALE 246721**  
 OVAL DISH 38X23,5 CM  
 14 IN<sup>15/16</sup> X 9 IN<sup>1/4</sup>



**BOL 247348**  
**COCOTTE** 14 CM - 50 CL  
 CUP 5 IN<sup>1/2</sup> - 16 OZ<sup>5/16</sup>

## ECLAT

Alldaydining  
 Porcelaine - Collection éphémère  
 Porcelain - Limited collection

MADE IN EUROPE

NEW



**MINI PLATEAU 247109**  
**RECTANGULAIRE** 16 X 12 CM  
 RECTANGULAR 6 in<sup>5/16</sup> x 4 in<sup>3/4</sup>  
 MINI TRAY



**MINI PLATEAU 247150**  
**RECTANGULAIRE** 16 X 12 CM  
 RECTANGULAR 6 in<sup>5/16</sup> x 4 in<sup>3/4</sup>  
 MINI TRAY



# COURONNE DORÉE

Finedining

Porcelaine

Porcelain

MADE IN EUROPE

NEW



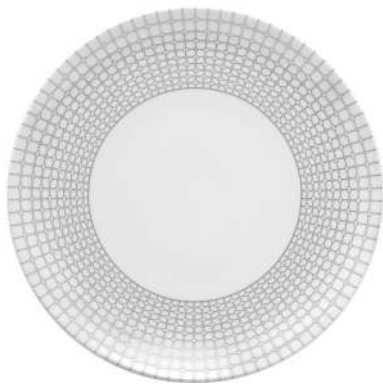

**ASSIETTE 247230**  
**PLATE** 32 CM - 12 IN<sup>5/8</sup>  
 ROUND  
 DINNER  
 PLATE

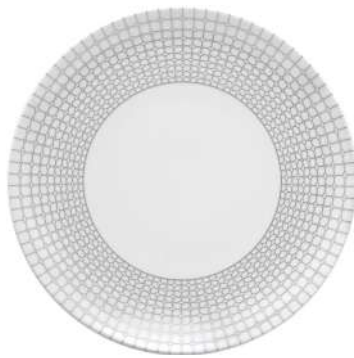

**247229**  
 29 CM - 11 IN<sup>7/16</sup>

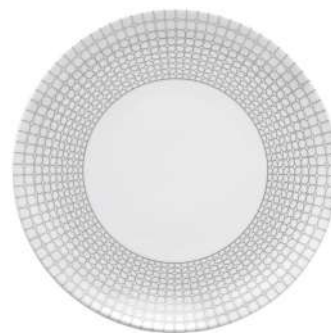

**247228**  
 26 CM - 10 IN<sup>1/4</sup>

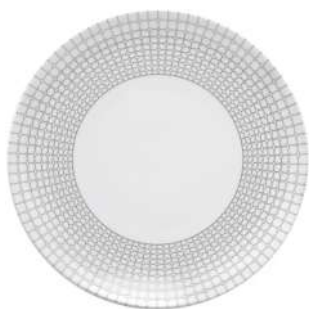

**ASSIETTE 247231**  
**DESSERT** 20 CM  
 7 IN<sup>7/8</sup>  
 ROUND  
 DESSERT  
 PLATE



**ASSIETTE 247233**  
**COUPE** 24 CM - 9 IN<sup>7/16</sup>  
 SHALLOW COUPE  
 BOWL, LARGE

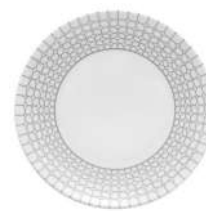

**ASSIETTE 247232**  
**À PAIN** 15 CM  
 5 IN<sup>7/8</sup>  
 BREAD  
 BUTTER  
 PLATE



**PLAT OVALE 247234**  
 OVAL DISH 38X23,5 CM  
 14 IN<sup>15/16</sup> X 9 IN<sup>1/4</sup>



**BOL 247344**  
**COCOTTE** 14 CM - 50 CL  
 CUP 5 IN<sup>1/2</sup> - 16 OZ<sup>5/16</sup>



**TASSE ESPRESSO 207756**  
 DEMITASSE CUP 10 CL - 3 OZ<sup>3/8</sup>

**SOUCOUPE ESPRESSO 247341**  
 DEMITASSE SAUCER 12,6 CM - Ø 4 IN<sup>5/16</sup>



**TASSE LUNGO 207757**  
 COFFEE/TEA CUP 20 CL - 6 OZ<sup>3/4</sup>

**SOUCOUPE LUNGO 247342**  
 COFFEE/TEA SAUCER 15,8 CM - Ø 5 IN<sup>7/8</sup>



**TASSE DÉJEUNER 207758**  
 BREAKFAST CUP 40 CL - 13 OZ<sup>1/2</sup>

**SOUCOUPE DÉJEUNER 247343**  
 BREAKFAST SAUCER 18 CM - 7 IN<sup>7/16</sup>





# COURONNE ARGENTÉ

---

Finedining

Porcelaine

Porcelain

MADE IN EUROPE

NEW



BLANC  
WHITE

NEW  
DORE  
GOLD



**ASSIETTE PLATE 245447**

ROUND EXT : 32,5 CM - 12 IN<sup>13/16</sup>  
DINNER PLATE INT : 20 CM - 7 IN<sup>7/8</sup>  
W/WIDE RIM

**245449**

EXT : 28,5 CM - 11 IN<sup>1/4</sup>  
INT : 17 CM - 6 IN<sup>11/16</sup>

**245451**

EXT : 22,5 CM - 8 IN<sup>7/8</sup>  
INT : 15 CM - 5 IN<sup>7/8</sup>

**246109**

**246110**

**246111**



Compatible avec les assiettes cocottes  
Compatible with the shallow plate/cups  
P138-139

**CLOCHE VERRE BOROSILICATE**

DOMES GLASS  
COVER **204043**

17X9 CM  
6 IN<sup>11/16</sup> X 3 IN<sup>9/16</sup>

**BOUCHON PORCELAINE**

PORCELAIN LID

**206504**  
5,2 CM - 2 IN<sup>1/8</sup>



**ASSIETTE GOURMET 245457**

**OVALE GRAND BASSIN** EXT : 32 X 27 CM - 12 IN<sup>5/8</sup> X 10 IN<sup>5/8</sup>  
SHALLOW BOWL INT : 14,5 CM - 5 IN<sup>5/16</sup>  
W/WIDE OVAL RIM 27 CL - 9 OZ<sup>1/8</sup>

**246114**

Compatible avec les bols cocottes  
Compatible with the deep plate/cups  
P138-139

**CLOCHE INOX**

DOMES STAINLESS STEEL  
COVER **182614**

24 CM - Ø 9 IN<sup>7/16</sup>

**ASSIETTE GOURMET 245455**

**OVALE PETIT BASSIN** EXT : 30 X 26 CM - 11 IN<sup>13/16</sup> X 10 IN<sup>1/4</sup>  
SHALLOW BOWL INT : 13,5 CM - 5 IN<sup>5/16</sup>  
W/WIDE OVAL RIM 17 CL - 5 OZ<sup>3/4</sup>

**246113**

Compatible avec les bols biseautés cocottes  
Compatible with the slanted plate/cups  
P138-139

**182301**

14,8 CM - Ø 5 IN<sup>13/16</sup>



**ASSIETTE 245741**

**À PÂTES/SOUBE** EXT : 29,5 CM - 11 IN<sup>5/8</sup>  
ROUND SOUP/PASTA INT : 17 CM - 6 IN<sup>11/16</sup>  
BOWL W/WIDE RIM

**246115**

**ASSIETTE À PAIN 245453**

ROUND BREAD EXT : 15 CM - 5 IN<sup>7/8</sup>  
& BUTTER PLATE INT : 9,5 CM - 3 IN<sup>3/4</sup>  
W/WIDE RIM

**246112**



**CAFÉTERIE - COFFEEWARE**

NEW  
P.178



# GRAPHIQUE CLASSIQUE

Finedining

Porcelaine

Porcelain

MADE IN EUROPE





**ASSIETTE PLATE 237318**  
 ROUND 26 CM - 10 IN<sup>1/4</sup>  
 DINNER PLATE



**237317**  
 24 CM - 9 IN<sup>7/16</sup>



**237316**  
 18 CM - 7 IN<sup>7/16</sup>



**237315**  
 14 CM - 5 IN<sup>1/2</sup>



**237321**  
**BOL DROIT** 24 CM - 9 IN<sup>7/16</sup>  
 STRAIGHT BOWL 2,6 L - 87 OZ<sup>15/16</sup>



**237320**  
 18 CM - 7 IN<sup>1/16</sup>  
 90 CL - 30 OZ<sup>7/16</sup>



**237319**  
 14 CM - 5 IN<sup>1/2</sup>  
 47 CL - 15 OZ<sup>7/8</sup>



**GRANDE 237324**  
**ASSIETTE CREUSE** 24 CM - 9 IN<sup>7/16</sup>  
 LARGE DEEP 1,3 L - 43 OZ<sup>15/16</sup>  
 PLATE



**BOL COUPE 237323**  
 ROUNDED BOWL 18 CM - 7 IN<sup>1/16</sup>  
 90 CL - 30 OZ<sup>7/16</sup>



**237322**  
 14 CM - 5 IN<sup>1/2</sup>  
 47 CL - 15 OZ<sup>7/8</sup>



# LA VAISSELLE DE L'ÉCONOME

Alldaydining

Porcelaine  
Porcelain

MADE IN EUROPE



## ROND ROUND



- ASSIETTE PLATE 207120**  
DINNER  
COUPE PLATE  
32 CM - 12 IN<sup>5/8</sup>
- 
- 207112**  
29 CM - 11 IN<sup>7/16</sup>
- 
- 207113**  
26 CM - 10 IN<sup>1/4</sup>
- 
- 207111**  
20 CM - 7 IN<sup>7/8</sup>
- 
- 207119**  
15 CM - 5 IN<sup>7/8</sup>



- ASSIETTE 207114**  
**CREUSE/**  
**CALOTTE**  
20 CM - 7 IN<sup>7/8</sup>  
ROUND  
SHALLOW  
BOWL



- BOL 142722**  
DEEP  
BOWL  
28 CM - 11 IN  
CONTENANCE : 2,5 L  
CAPACITY : 84 OZ<sup>3/16</sup>  
H : 12 CM - 4 IN<sup>3/4</sup>

- 136529**  
24 CM - 9 IN<sup>7/16</sup>  
CONTENANCE : 2 L  
CAPACITY : 67 OZ<sup>5/8</sup>  
H : 11 CM - 4 IN<sup>1/4</sup>

- 136511**  
20 CM - 7 IN<sup>7/8</sup>  
CONTENANCE : 1,30 L  
CAPACITY : 43 OZ<sup>5/16</sup>  
H : 9,5 CM - 3 IN<sup>3/4</sup>

- 136528**  
16 CM - 6 IN<sup>5/16</sup>  
CONTENANCE : 67 CL  
CAPACITY : 22 OZ<sup>5/8</sup>  
H : 7,5 CM - 2 IN<sup>15/16</sup>

- 154245**  
14 CM - 5 IN<sup>1/2</sup>  
CONTENANCE : 55 CL  
CAPACITY : 18 OZ<sup>5/8</sup>  
H : 8 CM - 2 IN<sup>11/16</sup>

- 136510**  
12 CM - 4 IN<sup>3/4</sup>  
CONTENANCE : 27 CL  
CAPACITY : 9 OZ<sup>1/8</sup>  
H : 5,5 CM - 2 IN<sup>3/16</sup>



- COUPE 136535**  
SHALLOW  
BOWL,  
FOOTED  
24 CM - 9 IN<sup>7/16</sup>  
H : 11 CM - 4 IN<sup>1/4</sup>
- 
- 136530**  
8 CM - 3 IN<sup>1/8</sup>  
H : 2,5 CM - 1 IN



- ASSIETTE 246108**  
**COUPE**  
**RONDE**  
24 CM - 9 IN<sup>7/16</sup>  
ROUND  
CEREAL  
PLATE



- MUG 234855 NEW**  
MUG 30 CL  
11 OZ<sup>13/16</sup>

## ACCESSOIRES ACCESSORIES



- PRÉSENTOIR 209382**  
**À GÂTEAUX**  
32 CM - 12 IN<sup>5/8</sup>  
ROUND  
APP/PIZZA/  
PRESENTATION  
STAND  
H : 10,5 CM - 4 IN<sup>1/4</sup>
- 
- 209381**  
25 CM - 9 IN<sup>13/16</sup>  
H : 8,5 CM - 2 IN<sup>3/16</sup>



- CLOCHE 239771**  
**EVENTO**  
Ø 28 CM - 11 IN  
**VERRE**  
**EVENTO**  
**239770**  
Ø 23 CM - 9 IN<sup>1/6</sup>  
DOME  
COVER
- 
- 239769**  
Ø 16 CM - 6 IN<sup>5/16</sup>



- PLAT À TARTE 136524**  
PIE/PIZZA 32 CM - 12 IN<sup>5/8</sup>  
PLATE,  
FLAT



- COFFRET 182915**  
**SALIÈRE/**  
**POIVRIÈRE**  
SALT & PEPPER  
CRUET



# MODULO

Alldaydining

Porcelaine

Porcelain

MADE IN EUROPE



## CARRÉ SQUARE



**ASSIETTE PLATE** **207118**  
SQUARE 28 CM - 11 IN  
COUPE PLATE

---

**207115**  
24 CM - 9 IN<sup>7/16</sup>

---

**207117**  
20 CM - 7 IN<sup>7/8</sup>

---

**207123**  
14 CM - 5 IN<sup>1/2</sup>



**COUPE** **136502**  
SQUARE BOWL,  
FOOTED COUPE 12 CM - 4 IN<sup>3/4</sup>  
H : 3,5 CM - 1 IN<sup>3/8</sup>

---

**136503**  
8 CM - 3 IN<sup>1/8</sup>  
H : 2,5 CM - 1 IN

## RECTANGLE RECTANGULAR



**ASSIETTE PLATE** **181485**  
DINNER 34 X 26 CM  
COUPE PLATE 13 IN<sup>3/8</sup> X 10 IN<sup>1/4</sup>

---

**207122**  
30 X 22 CM  
11 IN<sup>13/16</sup> X 8 IN<sup>11/16</sup>

---

**207110**  
26 X 18 CM  
10 IN<sup>1/4</sup> X 7 IN<sup>1/16</sup>



**PLAT** **207754**  
**RECTANGULAIRE** 40 X 16 CM  
RECTANGULAR DISH, 15 IN<sup>3/4</sup> X 6 IN<sup>5/16</sup>  
COUPE LARGE

---

**207753**  
20 X 12 CM  
7 IN<sup>7/8</sup> X 4 IN<sup>3/4</sup>



**SUPPORT** **161036**  
**PLATEAU** 30,5 X 10 CM  
TRAY STAND, 12 IN X 3 IN<sup>5/16</sup>  
3 PLACES

## NEWCOOK MODULO



**RAMEQUIN** **162015**  
RAMEKIN 9,5 CM - 3 IN<sup>3/4</sup>



**ASSIETTE** **162011**  
**À CRÈME** 14 CM - 5 IN<sup>1/2</sup>  
**BRÛLÉE**  
«CRÈME BRÛLÉE»  
DISH



**PLAT** **164138**  
**À ESCARGOTS** 16,6 X 11,2 CM -  
**6 PLACES** 6 IN<sup>9/16</sup> X 4 IN<sup>7/16</sup>  
SNAIL TRAY  
6 SPACES









KAOLIN  
KAOLIN



BLEU GALET  
BLUE  
**NEW**

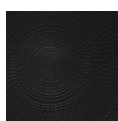

PIERRE DE LAVE  
LAVA STONE



TERRE D'OMBRE  
TAUPE



JADE  
GREEN JADE

# MODULO NATURE

---

Alldaydining

Grès  
Stoneware



PIERRE DE LAVE  
LAVA STONE

KAOLIN  
KAOLIN

JADE  
JADE GREEN



**ASSIETTE** **194455**  
**PLATE** 31,5 CM - 12 IN<sup>3/8</sup>  
ROUND

---

**DINNER PLATE** **194454**  
27,9 CM - 11 IN

---

**246750** **NEW**  
26 CM - 10 IN<sup>1/4</sup>

---

**194453**  
21 CM - 8 IN<sup>1/4</sup>

---

**230092**  
16 CM - 6 IN<sup>5/16</sup>

**184088**  
31,5 CM - 12 IN<sup>3/8</sup>

---

**184077**  
27,9 CM - 11 IN

---

**246751** **NEW**  
26 CM - 10 IN<sup>1/4</sup>

---

**184078**  
21 CM - 8 IN<sup>1/4</sup>

---

**209092**  
16 CM - 6 IN<sup>5/16</sup>

**235681**  
31,5 CM - 12 IN<sup>3/8</sup>

---

**235682**  
27,9 CM - 11 IN

---

**246753** **NEW**  
26 CM - 10 IN<sup>1/4</sup>

---

**235683**  
21 CM - 8 IN<sup>1/4</sup>

---

**235685**  
16 CM - 6 IN<sup>5/16</sup>



**ASSIETTE** **246755** **NEW**  
**COUPE** 22 CM - 8 IN<sup>11/16</sup>  
SALAD/  
CEREAL PLATE

**246756** **NEW**  
22 CM - 8 IN<sup>11/16</sup>

**246758** **NEW**  
22 CM - 8 IN<sup>11/16</sup>



**ASSIETTE** **194452**  
**CALOTTE** 21 CM - 8 IN<sup>1/4</sup>  
SALAD/  
CEREAL PLATE

**184079**  
21 CM - 8 IN<sup>1/4</sup>

**235684**  
21 CM - 8 IN<sup>1/4</sup>



**COUPE** **194457**  
**CALOTTE** 17,7 CM - 6 IN<sup>5/16</sup>  
SALAD/  
CEREAL PLATE  
DEEP

**184086**  
17,7 CM - 6 IN<sup>5/16</sup>  
H 5,5 CM - 2 IN<sup>3/16</sup>

**235687**  
17,7 CM - 6 IN<sup>5/16</sup>  
H 5,5 CM - 2 IN<sup>3/16</sup>



**COUPE RONDE** **234455**  
ROUND 25 CM - 9 IN<sup>13/16</sup>  
COUPE BOWL

**234449**  
25 CM - 9 IN<sup>13/16</sup>

**235688**  
25 CM - 9 IN<sup>13/16</sup>



TERRE D'OMBRE  
TAUPE



**184101**  
31,5 CM - 12 IN<sup>3/8</sup>

**184090**  
27,9 CM - 11 IN

**246752** **NEW**  
26 CM - 10 IN<sup>1/4</sup>

**184091**  
21 CM - 8 IN<sup>1/4</sup>

**209093**  
16 CM - 6 IN<sup>5/16</sup>

BLEU GALET  
BLUE  
**NEW**



**225342**  
31,5 CM - 12 IN<sup>3/8</sup>

**225343**  
27,9 CM - 11 IN

**246747**  
26 CM - 10 IN<sup>1/4</sup>

**225344**  
21 CM - 8 IN<sup>1/4</sup>

**225353**  
16 CM - 6 IN<sup>5/16</sup>



**246757** **NEW**  
22 CM - 8 IN<sup>11/16</sup>



**246748**  
22 CM - 8 IN<sup>11/16</sup>



**184092**  
21 CM - 8 IN<sup>1/4</sup>



**225345**  
21 CM - 8 IN<sup>1/4</sup>



**184099**  
17,7 CM - 6 IN<sup>15/16</sup>  
H 5,5 CM - 2 IN<sup>3/16</sup>



**225347**  
17,7 CM - 6 IN<sup>15/16</sup>  
H 5,5 CM - 2 IN<sup>3/16</sup>



**234451**  
25 CM - 9 IN<sup>13/16</sup>



**234457**  
25 CM - 9 IN<sup>13/16</sup>

PIERRE DE LAVE  
LAVA STONE



**SALADIER** 194462  
SALAD BOWL 24 CM - 9 IN<sup>7/16</sup>  
H 8 CM - 3 IN<sup>3/16</sup>

KAOLIN  
KAOLIN



**184087**  
24 CM - 9 IN<sup>7/16</sup>  
H 8 CM - 3 IN<sup>3/16</sup>

JADE  
JADE GREEN



**235689**  
24 CM - 9 IN<sup>7/16</sup>  
H 8 CM - 3 IN<sup>3/16</sup>



**BOL** 246759 **NEW**  
BOWL 14,5 CM - 5 IN<sup>11/16</sup>



**246760** **NEW**  
14,5 CM - 5 IN<sup>11/16</sup>



**246762** **NEW**  
14,5 CM - 5 IN<sup>11/16</sup>



**BOL À DÉJEUNER** 246759  
SOUP/ BREAKFAST BOWL 14 CM - 5 IN<sup>11/16</sup>  
58 CL - 19 OZ<sup>5/8</sup>



**246760**  
14 CM - 5 IN<sup>11/16</sup>  
58 CL - 19 OZ<sup>5/8</sup>



**246762**  
14 CM - 5 IN<sup>11/16</sup>  
58 CL - 19 OZ<sup>5/8</sup>



**COUPELLE** 194458  
SMALL BOWL/CUP 10 CM - 3 IN<sup>15/16</sup>  
H 6 CM - 2 IN<sup>3/8</sup>



**184085**  
10 CM - 3 IN<sup>15/16</sup>  
H 6 CM - 2 IN<sup>3/8</sup>



**235686**  
10 CM - 3 IN<sup>15/16</sup>  
H 6 CM - 2 IN<sup>3/8</sup>

## CAFÉTERIE COFFEEWARE



**MUG** 194461  
MUG 33 CL - 11 OZ<sup>3/16</sup>



**184083**  
33 CL - 11 OZ<sup>3/16</sup>



**246420** **NEW**  
33 CL - 11 OZ<sup>3/16</sup>



**TASSE À CAFÉ** 194459  
DEMITASSE CUP 11,5 CL - 3 OZ<sup>7/8</sup>



**184081**  
11,5 CL - 3 OZ<sup>7/8</sup>



**235690**  
11,5 CL - 3 OZ<sup>7/8</sup>

**SOUCOUPE À CAFÉ** 194460  
DEMITASSE SAUCER 12,5 CM - Ø 4 IN<sup>15/16</sup>

**184082**  
12,5 CM - Ø 4 IN<sup>15/16</sup>

**235691**  
12,5 CM - Ø 4 IN<sup>15/16</sup>

**TASSE À THÉ** 230093  
TEA CUP 25 CL - 8 OZ<sup>7/16</sup>

**230163**  
25 CL - 8 OZ<sup>7/16</sup>

**235692**  
25 CL - 8 OZ<sup>7/16</sup>

**SOUCOUPE À THÉ** 230094  
DEMITASSE/TEA SAUCER 15 CM - Ø 5 IN<sup>7/8</sup>

**230164**  
15 CM - Ø 5 IN<sup>7/8</sup>

**235693**  
15 CM - Ø 5 IN<sup>7/8</sup>



TERRE D'OMBRE  
TAUPE



**184100**  
24 CM - 9 IN<sup>7/16</sup>  
H 8 CM - 3 IN<sup>3/16</sup>



**246761** **NEW**  
14,5 CM - 5 IN<sup>11/16</sup>



**246761**  
14 CM - 5 IN<sup>11/16</sup>  
58 CL - 19 OZ<sup>5/8</sup>



**184098**  
10 CM - 3 IN<sup>15/16</sup>  
H 6 CM - 2 IN<sup>3/8</sup>



**184096**  
33 CL - 11 OZ<sup>3/16</sup>



**184094**  
11,5 CL - 3 OZ<sup>7/8</sup>

**184095**  
12,5 CM - Ø 4 IN<sup>15/16</sup>

**230165**  
25 CL - 8 OZ<sup>7/16</sup>

**230166**  
15 CM - Ø 5 IN<sup>7/8</sup>

BLEU GALET  
BLUE  
**NEW**



**225349**  
24 CM - 9 IN<sup>7/16</sup>  
H 8 CM - 3 IN<sup>3/16</sup>



**246749**  
14,5 CM - 5 IN<sup>11/16</sup>



**246777**  
14 CM - 5 IN<sup>11/16</sup>  
58 CL - 19 OZ<sup>5/8</sup>



**225346**  
10 CM - 3 IN<sup>15/16</sup>  
H 6 CM - 2 IN<sup>3/8</sup>



**246746**  
33 CL - 11 OZ<sup>3/16</sup>



**225351**  
11,5 CL - 3 OZ<sup>7/8</sup>

**225352**  
12,5 CM - Ø 4 IN<sup>15/16</sup>

**230167**  
25 CL - 8 OZ<sup>7/16</sup>

**230168**  
15 CM - Ø 5 IN<sup>7/8</sup>



**ASSIETTE PLATE 243263**  
**RONDE** 32 CM - 12 IN<sup>5/8</sup>  
ROUND  
DINNER  
COUPE PLATE



**243265**  
28 CM - 11 IN



**243267**  
24 CM - 9 IN<sup>7/16</sup>



**ASSIETTE À PAIN 243269**  
ROUND 15 CM - 5 IN<sup>7/8</sup>  
BREAD PLATE



**ASSIETTE 243271**  
**COUPE RONDE** 24 CM - 9 IN<sup>7/16</sup>  
ROUND  
CEREAL PLATE



**BOL 243273**  
DEEP 18 CM - 7 IN<sup>1/16</sup>  
BOWL



**COUPELLE 243275**  
RONDE 13 CM - 5 IN<sup>1/8</sup>





# RIVAGE

Alldaydining

Porcelaine

Porcelain

MADE IN EUROPE





# LA CAFÉTERIE

Teatime

Le thé et le café sont des univers où le plaisir des sens est décuplé par le plaisir esthétique. Pour rendre ces instants de dégustation uniques, DEGRENNE propose une large sélection de tasses et accessoires. Collection iconique de la marque depuis 1953, redécouvrez SALAM et réunissez tous les éléments pour maîtriser l'Art du Thé.

Drinking tea and coffee is a sensory delight heightened by the sheer aesthetic pleasure of the experience. DEGRENNE offers a wide range of cups and accessories to make tea and coffee drinking a unique experience. An iconic DEGRENNE collection since 1953 - why not seize the opportunity to rediscover SALAM and gather together the essentials needed to be skilled in the art of tea.

BLANCHE  
WHITE

Cloche inox miroir - Mirror stainless steel lid



**THÉIÈRE 211990**  
TEA POT 8 TASSES - 8 CUPS  
130 CL - 43 OZ<sup>15/16</sup>

**211989**  
6 TASSES - 6 CUPS  
100 CL - 33 OZ<sup>13/16</sup>

**211988**  
4 TASSES - 4 CUPS  
70 CL - 23 OZ<sup>11/16</sup>

**211987**  
2 TASSES - 2 CUPS  
35 CL - 11 OZ<sup>13/16</sup>

NOIRE  
BLACK

Cloche inox brossée - Brushed stainless steel lid



**211994**  
8 TASSES - 8 CUPS  
130 CL - 43 OZ<sup>15/16</sup>

**211993**  
6 TASSES - 6 CUPS  
100 CL - 33 OZ<sup>13/16</sup>

**211992**  
4 TASSES - 4 CUPS  
70 CL - 23 OZ<sup>11/16</sup>

**211991**  
2 TASSES - 2 CUPS  
35 CL - 11 OZ<sup>13/16</sup>

NOIRE  
BLACK

Cloche aluminium noire mat - Black aluminium lid



**216414**  
6 TASSES - 6 CUPS  
100 CL - 33 OZ<sup>13/16</sup>

**216410**  
4 TASSES - 4 CUPS  
70 CL - 23 OZ<sup>11/16</sup>

**243214**  
2 TASSES - 2 CUPS  
35 CL - 11 OZ<sup>13/16</sup>

## ACCESSOIRES ACCESSORIES

BLANCHE  
WHITE



**CORPS 189949**  
**THÉIÈRE** 8 TASSES - 8 CUPS  
TEA POT 130 CL - 43 OZ<sup>15/16</sup>

**189948**  
6 TASSES - 6 CUPS  
100 CL - 33 OZ<sup>13/16</sup>

**189947**  
4 TASSES - 4 CUPS  
70 CL - 23 OZ<sup>11/16</sup>

**189946**  
2 TASSES - 2 CUPS  
35 CL - 11 OZ<sup>13/16</sup>

NOIRE  
BLACK



**150447**  
8 TASSES - 8 CUPS  
130 CL - 43 OZ<sup>15/16</sup>

**150456**  
6 TASSES - 6 CUPS  
100 CL - 33 OZ<sup>13/16</sup>

**150455**  
4 TASSES - 4 CUPS  
70 CL - 23 OZ<sup>11/16</sup>

**150450**  
2 TASSES - 2 CUPS  
35 CL - 11 OZ<sup>13/16</sup>



**FEUTRE 217133**  
**NOIR** 8 TASSES - 8 CUPS  
**ISOLANT**  
BLACK  
TEA POT **217132**  
FELT 6 TASSES - 6 CUPS

**217131**  
4 TASSES - 4 CUPS

**217130**  
2 TASSES - 2 CUPS



**BOUCHON 205136**  
**THÉIÈRE** 6/8 TASSES - 6/8 CUPS  
TEA POT  
LID **205135**  
2/4 TASSES - 2/4 CUPS



**210576**  
6/8 TASSES - 6/8 CUPS  
**210575**  
2/4 TASSES - 2/4 CUPS



**INFUSEUR 240331**  
STAINLESS STEEL 6/8 TASSES - 6/8 CUPS  
FILTER **240330**  
4 TASSES - 4 CUPS



**SUCRIER 187276**  
SUGAR BOWL 28 CL - 9 OZ<sup>7/16</sup>



**CORPS 187283**  
**SUCRIER**  
SUGAR BOWL WITHOUT LID



**150475** **150469**  
28 CL - 9 OZ<sup>7/16</sup>



**150485**  
15 CL - 5 OZ<sup>1/16</sup>

**CRÉMIER 187277**  
CREAMER, JUG 15 CL - 5 OZ<sup>1/16</sup>



# SALAM

Alldaydining

  
MADE IN FRANCE



ZINC  
BLANC - WHITE



**216416**  
6 TASSES - 6 CUPS  
100 CL - 33 OZ<sup>13/16</sup>

BRONZE  
BLANC - WHITE



**216415**  
6 TASSES - 6 CUPS  
100 CL - 33 OZ<sup>13/16</sup>

DORÉ - GOLDEN  
BLANC - WHITE



**234217**  
6 TASSES - 6 CUPS  
100 CL - 33 OZ<sup>13/16</sup>

BLEU - BLUE  
BLANC - WHITE



**225359**  
6 TASSES - 6 CUPS  
100 CL - 33 OZ<sup>13/16</sup>



**216412**  
4 TASSES - 4 CUPS  
70 CL - 23 OZ<sup>11/16</sup>



**216411**  
4 TASSES - 4 CUPS  
70 CL - 23 OZ<sup>11/16</sup>



**234216**  
4 TASSES - 4 CUPS  
70 CL - 23 OZ<sup>11/16</sup>



**225358**  
4 TASSES - 4 CUPS  
70 CL - 23 OZ<sup>11/16</sup>

BRONZE  
NOIR - BLACK



**237415**  
6 TASSES - 6 CUPS  
100 CL - 33 OZ<sup>13/16</sup>

EMERAUDE-EMERALD  
NOIR - BLACK



**240138**  
6 TASSES - 6 CUPS  
100 CL - 33 OZ<sup>13/16</sup>

ROUGE(Pomme d'amour) - RED  
NOIR - BLACK



**238935**  
6 TASSES - 6 CUPS  
100 CL - 33 OZ<sup>13/16</sup>

ROUGE(Pomme d'amour) - RED  
BLANC - WHITE



**238934**  
6 TASSES - 6 CUPS  
100 CL - 33 OZ<sup>13/16</sup>



**237414**  
4 TASSES - 4 CUPS  
70 CL - 23 OZ<sup>11/16</sup>



**240125**  
4 TASSES - 4 CUPS  
70 CL - 23 OZ<sup>11/16</sup>

OR - GOLD  
BLANC - WHITE  
Corps en porcelaine de Limoges  
Limoges porcelain body



**243794**  
4 TASSES - 4 CUPS  
70 CL - 23 OZ<sup>11/16</sup>



MONOCHROME BLANC  
MONOCHROME WHITE  
Cloche inox blanche - White stainless steel lid



**242322**  
6 TASSES - 6 CUPS  
100 CL - 33 OZ<sup>13/16</sup>

MONOCHROME BLEU GOURMET  
MONOCHROME GOURMET BLUE  
Cloche inox bleue - Blue stainless steel lid



**242324**  
6 TASSES - 6 CUPS  
100 CL - 33 OZ<sup>13/16</sup>

MONOCHROME ROSE NUDE  
MONOCHROME PINK NUDE  
Cloche inox rose nude - Pink nude stainless steel lid



**242326**  
6 TASSES - 6 CUPS  
100 CL - 33 OZ<sup>13/16</sup>

MONOCHROME VERT AMANDE  
MONOCHROME ALMOND GREEN  
Cloche inox vert amande - Almond green stainless steel lid



**242328**  
6 TASSES - 6 CUPS  
100 CL - 33 OZ<sup>13/16</sup>



**242321**  
4 TASSES - 4 CUPS  
70 CL - 23 OZ<sup>11/16</sup>



**242323**  
4 TASSES - 4 CUPS  
70 CL - 23 OZ<sup>11/16</sup>



**242325**  
4 TASSES - 4 CUPS  
70 CL - 23 OZ<sup>11/16</sup>



**242327**  
4 TASSES - 4 CUPS  
70 CL - 23 OZ<sup>11/16</sup>





# SALAM MONOCHROME

Alldaydining



BLANC  
WHITE  
Porcelaine - Porcelain



**TASSE ESPRESSO 242636**  
ESPRESSO CUP 10 CL - 3 OZ<sup>3/8</sup>

BLEU GOURMET  
GOURMET BLUE  
Grès - Stoneware



**242640**  
10 CL - 3 OZ<sup>3/8</sup>

ROSE NUDE  
PINK NUDE  
Grès - Stoneware



**242642**  
10 CL - 3 OZ<sup>3/8</sup>

VERT AMANDE  
ALMOND GREEN  
Grès - Stoneware



**242638**  
10 CL - 3 OZ<sup>3/8</sup>



**TASSE À THÉ 242628**  
**CAPPUCCINO** 25 CL - 8 OZ<sup>29/64</sup>  
TEA AND  
CAPPUCCINO CUP



**242632**  
25 CL - 8 OZ<sup>29/64</sup>



**242634**  
25 CL - 8 OZ<sup>29/64</sup>



**242630**  
25 CL - 8 OZ<sup>29/64</sup>



**TASSE À DÉJEUNER 242620**  
BREAKFAST CUP 39 CL - 13 OZ<sup>3/16</sup>



**242624**  
39 CL - 13 OZ<sup>3/16</sup>



**242626**  
39 CL - 13 OZ<sup>3/16</sup>



**242622**  
39 CL - 13 OZ<sup>3/16</sup>



**SOUCOUPE 242644**  
**CÉRAMIQUE** 15 CM - 5 IN<sup>7/8</sup>  
CERAMIC SAUCER



**242648**  
15 CM - 5 IN<sup>7/8</sup>



**242650**  
15 CM - 5 IN<sup>7/8</sup>



**242646**  
15 CM - 5 IN<sup>7/8</sup>

INOX  
STAINLESS STEEL  
MADE IN FRANCE



**SOUCOUPE 242652**  
**INOX** 15 CM - 5 IN<sup>7/8</sup>  
STAINLESS  
STEEL SAUCER



# EMPILEO CAFETERIE

---

Alldaydining  
C ramique  
Ceramic

MADE IN EUROPE





**TASSE À CAFÉ 210946**  
COFFEE/TEA POT 11 CL - 3 OZ<sup>3/4</sup>



**SOUCOUPE CAFÉ/THÉ 210950**  
DEMITASSE 16 CM - 6 IN<sup>5/16</sup>  
COFFEE/TEA SAUCER



**TASSE À THÉ 210947**  
COFFEE/TEA POT 25 CL - 8 OZ<sup>7/16</sup>

**SOUCOUPE DÉJEUNER/ MUG 210951**  
BREAKFAST MUG 18 CM - 7 IN<sup>1/16</sup>  
SAUCER



**TASSE À DÉJEUNER 210948**  
BREAKFAST CUP 42 CL - 14 OZ<sup>3/16</sup>



**MUG À THÉ 210949**  
TEA MUG 38 CL - 12 OZ<sup>7/8</sup>

## MODULO

Alldaydining

Porcelain

MADE IN EUROPE



NEW



**MUG 234855**  
MUG 30 CL - 11 OZ<sup>13/16</sup>



# SALAM THÉ

Alldaydining

Porcelaine

Porcelain

MADE IN EUROPE



**L**



**TASSE ESPRESSO 227828**  
DEMITASSE CUP 10 CL - 3 OZ<sup>3/8</sup> - 5,7 CM - 2 IN<sup>1/4</sup>

**SOUCOUPE ESPRESSO 227831**  
DEMITASSE SAUCER 12,6 CM - Ø 4 IN<sup>15/16</sup>



**TASSE LUNGO 227829**  
COFFEE/TEA CUP 25 CL - 8 OZ<sup>7/16</sup> - 8,5 CM - 3 IN<sup>3/8</sup>

**SOUCOUPE LUNGO 227832**  
COFFEE/TEA SAUCER 15,8 CM - Ø 6 IN<sup>1/4</sup>

**L COUTURE**



**TASSE ESPRESSO 227828**  
DEMITASSE CUP 10 CL - 3 OZ<sup>3/8</sup> - 5,7 CM - 2 IN<sup>1/4</sup>

**SOUCOUPE ESPRESSO 237404**  
DEMITASSE SAUCER 12,6 CM - Ø 4 IN<sup>15/16</sup>



**TASSE LUNGO 227829**  
COFFEE/TEA CUP 25 CL - 8 OZ<sup>7/16</sup> - 8,5 CM - 3 IN<sup>3/8</sup>

**SOUCOUPE LUNGO 237405**  
COFFEE/TEA SAUCER 15,8 CM - Ø 6 IN<sup>1/4</sup>

**L FRAGMENT**

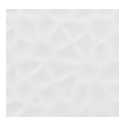

**TASSE ESPRESSO 227828**  
DEMITASSE CUP 10 CL - 3 OZ<sup>3/8</sup> - 5,7 CM - 2 IN<sup>1/4</sup>

**SOUCOUPE ESPRESSO 227849**  
DEMITASSE SAUCER 12,6 CM - Ø 4 IN<sup>15/16</sup>



**TASSE LUNGO 227829**  
COFFEE/TEA CUP 25 CL - 8 OZ<sup>7/16</sup> - 8,5 CM - 3 IN<sup>3/8</sup>

**SOUCOUPE LUNGO 227850**  
COFFEE/TEA SAUCER 15,8 CM - Ø 6 IN<sup>1/4</sup>

**L PERLES DE ROSEE**

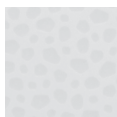

**TASSE ESPRESSO 227828**  
DEMITASSE CUP 10 CL - 3 OZ<sup>3/8</sup> - 5,7 CM - 2 IN<sup>1/4</sup>

**SOUCOUPE ESPRESSO 233928**  
DEMITASSE SAUCER 12,6 CM - Ø 4 IN<sup>15/16</sup>



**TASSE LUNGO 227829**  
COFFEE/TEA CUP 25 CL - 8 OZ<sup>7/16</sup> - 8,5 CM - 3 IN<sup>3/8</sup>

**SOUCOUPE LUNGO 233929**  
COFFEE/TEA SAUCER 15,8 CM - Ø 6 IN<sup>1/4</sup>

**S D ONE**



**TASSE ESPRESSO 242910**  
ESPRESSO CUP H 6,3 CM - 2 IN<sup>1/2</sup>  
Ø 6 CM - 2 IN<sup>3/8</sup>  
7 CL - 2 OZ<sup>3/8</sup>

**SOUCOUPE 242914**  
SAUCER Ø 14 CM - 5 IN<sup>1/2</sup>



**TASSE THÉ/CAFÉ 242912**  
TEA/COFFEE CUP H 8 CM - 3 IN<sup>1/8</sup>  
Ø 7,8 CM - 3 IN<sup>1/16</sup>  
15 CL - 5 OZ<sup>1/16</sup>

**SOUCOUPE 242914**  
SAUCER Ø 14 CM - 5 IN<sup>1/2</sup>

# CAFÉTERIE COLLECTION L

---

Finedining

Haute Porcelaine de Limoges  
High Limoges Porcelain



OR  
GOLD



**TASSE À CAFÉ 241093**  
COFFEE CUP 10 CL - 3 OZ<sup>3/8</sup>

**SOUCOUPE À CAFÉ 241094**  
COFFEE SAUCER 12,5 CM - Ø 4 IN<sup>15/16</sup>



**TASSE À THÉ 247598**  
COFFEE/TEA CUP 25 CL - 8 OZ<sup>7/16</sup>

**SOUCOUPE À THÉ 241105**  
COFFEE/TEA SAUCER 15 CM - Ø 5 IN<sup>7/8</sup>



**TASSE DÉJEUNER 241102**  
BREAKFAST CUP 40 CL - 13 OZ<sup>1/2</sup>

**SOUCOUPE DÉJEUNER 241103**  
BREAKFAST SAUCER 19 CM - 7 IN<sup>1/2</sup>



**THÉIÈRE 241100**  
COFFEE/TEA POT 1 L - 33 OZ<sup>13/16</sup>



**SUCRIER 241101**  
SUGAR BOWL 15 CL - 5 OZ<sup>1/16</sup>

PLATINE  
SILVER



**TASSE À CAFÉ 203238**  
COFFEE CUP 10 CL - 3 OZ<sup>3/8</sup>

**SOUCOUPE À CAFÉ 203239**  
COFFEE SAUCER 12,5 CM - Ø 4 IN<sup>15/16</sup>



**TASSE À THÉ 247600**  
COFFEE/TEA CUP 25 CL - 8 OZ<sup>7/16</sup>

**SOUCOUPE À THÉ 203241**  
COFFEE/TEA SAUCER 15 CM - Ø 5 IN<sup>7/8</sup>



**TASSE DÉJEUNER 203242**  
BREAKFAST CUP 40 CL - 13 OZ<sup>1/2</sup>

**SOUCOUPE DÉJEUNER 203243**  
BREAKFAST SAUCER 19 CM - 7 IN<sup>1/2</sup>



**THÉIÈRE 203245**  
COFFEE/TEA POT 1 L - 33 OZ<sup>13/16</sup>



**SUCRIER 203250**  
SUGAR BOWL 15 CL - 5 OZ<sup>1/16</sup>



# CAFÉTERIE GALON

Finedining

Haute Porcelaine de Limoges  
High Limoges Porcelain



## BORÉAL



**TASSE À CAFÉ 186791**  
DEMITASSE CUP 9 CL - 3 OZ<sup>1/16</sup>

**SOUCOUPE À CAFÉ 186792**  
DEMITASSE SAUCER 14X12 CM  
Ø 5 IN<sup>1/2</sup> X 4 IN<sup>3/4</sup>



**TASSE À THÉ 186793**  
COFFEE/TEA CUP 15 CL - 6 OZ<sup>3/4</sup>

**SOUCOUPE À THÉ 186794**  
COFFEE/TEA SAUCER 16,5 X 14 CM  
Ø 6 IN<sup>1/2</sup> X 5 IN<sup>1/2</sup>



**TASSE DÉJEUNER 186795**  
BREAKFAST CUP 40 CL - 13 OZ<sup>1/2</sup>

**SOUCOUPE DÉJEUNER 186796**  
BREAKFAST SAUCER 20X17 CM  
Ø 7 IN<sup>7/8</sup> X 6 IN<sup>11/16</sup>

## BORÉAL SATIN



**TASSE À CAFÉ 186791**  
DEMITASSE CUP 9 CL - 3 OZ<sup>1/16</sup>

**SOUCOUPE À CAFÉ 193321**  
DEMITASSE SAUCER 14X12 CM  
Ø 5 IN<sup>1/2</sup> X 4 IN<sup>3/4</sup>



**TASSE À THÉ 186793**  
COFFEE/TEA CUP 15 CL - 6 OZ<sup>3/4</sup>

**SOUCOUPE À THÉ 193322**  
COFFEE/TEA SAUCER 16,5 X 14 CM  
Ø 6 IN<sup>1/2</sup> X 5 IN<sup>1/2</sup>



**TASSE DÉJEUNER 186795**  
BREAKFAST CUP 40 CL - 13 OZ<sup>1/2</sup>

**SOUCOUPE DÉJEUNER 193323**  
BREAKFAST SAUCER 20X17 CM  
Ø 7 IN<sup>7/8</sup> X 6 IN<sup>11/16</sup>



# CAFÉTERIE BORÉAL

Alldaydining

Porcelaine

Porcelain

MADE IN EUROPE



DORÉ  
GOLD



**TASSE ESPRESSO 207756**  
DEMITASSE CUP 10 CL - 3 OZ<sup>3/8</sup>

**SOUCOUPE ESPRESSO 247345**  
DEMITASSE SAUCER 12,6 CM - Ø 4 IN<sup>5/16</sup>



**TASSE LUNGO 207757**  
COFFEE/TEA CUP 20 CL - 6 OZ<sup>3/4</sup>

**SOUCOUPE LUNGO 247346**  
COFFEE/TEA SAUCER 15,8 CM - Ø 5 IN<sup>7/8</sup>



**TASSE DÉJEUNER 207758**  
BREAKFAST CUP 40 CL - 13 OZ<sup>1/2</sup>

**SOUCOUPE DÉJEUNER 247347**  
BREAKFAST SAUCER 18 CM - 7 IN<sup>7/16</sup>

ARGENTÉ  
SILVER



**TASSE ESPRESSO 207756**  
DEMITASSE CUP 10 CL - 3 OZ<sup>3/8</sup>

**SOUCOUPE ESPRESSO 247341**  
DEMITASSE SAUCER 12,6 CM - Ø 4 IN<sup>5/16</sup>



**TASSE LUNGO 207757**  
COFFEE/TEA CUP 20 CL - 6 OZ<sup>3/4</sup>

**SOUCOUPE LUNGO 247342**  
COFFEE/TEA SAUCER 15,8 CM - Ø 5 IN<sup>7/8</sup>



**TASSE DÉJEUNER 207758**  
BREAKFAST CUP 40 CL - 13 OZ<sup>1/2</sup>

**SOUCOUPE DÉJEUNER 247343**  
BREAKFAST SAUCER 18 CM - 7 IN<sup>7/16</sup>



# CAFÉTERIE COURONNE

Finedining  
Haute Porcelaine de Limoges  
High Limoges Porcelain

MADE IN EUROPE

**NEW**



BLANC  
WHITE

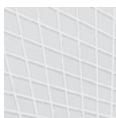

**TASSE ESPRESSO 207756**  
DEMITASSE CUP 10 CL - 3 OZ<sup>3/8</sup>

**SOUCOUPE ESPRESSO 246162**  
DEMITASSE SAUCER 12,6 CM - Ø 4 IN<sup>15/16</sup>



**TASSE LUNGO 207757**  
COFFEE/TEA CUP 20 CL - 6 OZ<sup>3/4</sup>

**SOUCOUPE LUNGO 246163**  
COFFEE/TEA SAUCER 15 CM - Ø 5 IN<sup>7/8</sup>



**TASSE DÉJEUNER 207758**  
BREAKFAST CUP 40 CL - 13 OZ<sup>1/2</sup>

**SOUCOUPE DÉJEUNER 246268**  
BREAKFAST SAUCER 18 CM - 7 IN<sup>7/16</sup>

DORÉ  
GOLD  
**NEW**



**TASSE ESPRESSO 207756**  
DEMITASSE CUP 10 CL - 3 OZ<sup>3/8</sup>

**SOUCOUPE ESPRESSO 246164**  
DEMITASSE SAUCER 12,6 CM - Ø 4 IN<sup>5/16</sup>



**TASSE LUNGO 207757**  
COFFEE/TEA CUP 20 CL - 6 OZ<sup>3/4</sup>

**SOUCOUPE LUNGO 246165**  
COFFEE/TEA SAUCER 15,8 CM - Ø 5 IN<sup>7/8</sup>



**TASSE DÉJEUNER 207758**  
BREAKFAST CUP 40 CL - 13 OZ<sup>1/2</sup>

**SOUCOUPE DÉJEUNER 246269**  
BREAKFAST SAUCER 18 CM - 7 IN<sup>7/16</sup>



# CAFÉTERIE GRAPHIQUE CLASSIQUE

---

Alldaydining

Porcelaine  
Porcelain

MADE IN EUROPE





**TASSE ESPRESSO 207756**  
DEMITASSE CUP 10 CL - 3 OZ<sup>3/8</sup>



**TASSE LUNGO 207757**  
COFFEE/TEA CUP 20 CL - 6 OZ<sup>3/4</sup>



**TASSE DÉJEUNER 207758**  
BREAKFAST CUP 40 CL - 13 OZ<sup>1/2</sup>

**SOUCOUPE ESPRESSO 207759**  
DEMITASSE SAUCER 12,5 CM - Ø 4 IN<sup>5/16</sup>

**SOUCOUPE LUNGO 207760**  
COFFEE/TEA SAUCER 15,8 CM - Ø 5 IN<sup>7/8</sup>

**SOUCOUPE DÉJEUNER 207761**  
BREAKFAST SAUCER 18 CM - 7 IN<sup>7/16</sup>



**VERSEUSE 207764**  
COFFEE/TEA POT 80 CL - 27 OZ<sup>1/16</sup>

**207763**  
40 CL - 13 OZ<sup>1/2</sup>



**COUVERCLES 210912**  
**VERSEUSES** 8,4 CM - 3 IN<sup>5/16</sup>  
LIDS FOR 80 CL - 27 OZ<sup>1/16</sup>  
TEA POTS

**210911**  
6,6 CM - 2 IN<sup>5/8</sup>  
40 CL - 13 OZ<sup>1/2</sup>



**CRÉMIER 207762**  
CREAM JUG 10 CL - 3 OZ<sup>3/8</sup>



**MUG 247354 NEW**  
MUG 20 CL - 6 OZ<sup>3/4</sup>



**NEWPORT**  
P 224



# CAFÉTERIE NEWPORT

Finedining

Porcelaine

Porcelain

MADE IN EUROPE



PIERRE DE LAVE  
LAVA STONE

KAOLIN  
KAOLIN

BLEU GALET  
BLUE  
NEW

TERRE D'OMBRE  
TAUPE

JADE  
JADE GREEN



**TASSE À CAFÉ 194459**  
DEMITASSE CUP 11,5 CL - 3 OZ<sup>7/8</sup>

**184081**  
11,5 CL - 3 OZ<sup>7/8</sup>

**225351**  
11,5 CL - 3 OZ<sup>7/8</sup>

**184094**  
11,5 CL - 3 OZ<sup>7/8</sup>

**235690**  
11,5 CL - 3 OZ<sup>7/8</sup>

**SOUCOUBE À CAFÉ 194460**  
DEMITASSE SAUCER 12,5 CM - Ø 4 IN<sup>15/16</sup>

**184082**  
12,5 CM - Ø 4 IN<sup>15/16</sup>

**225352**  
12,5 CM - Ø 4 IN<sup>15/16</sup>

**184095**  
12,5 CM - Ø 4 IN<sup>15/16</sup>

**235691**  
12,5 CM - Ø 4 IN<sup>15/16</sup>



**TASSE À THÉ 230093**  
TEA CUP 25 CL - 8 OZ<sup>7/16</sup>

**230163**  
25 CL - 8 OZ<sup>7/16</sup>

**230167**  
25 CL - 8 OZ<sup>7/16</sup>

**230165**  
25 CL - 8 OZ<sup>7/16</sup>

**235692**  
25 CL - 8 OZ<sup>7/16</sup>

**SOUCOUBE À THÉ 230094**  
DEMITASSE/TEA SAUCER 15 CM - Ø 5 IN<sup>7/8</sup>

**230164**  
15 CM - Ø 5 IN<sup>7/8</sup>

**230168**  
15 CM - Ø 5 IN<sup>7/8</sup>

**230166**  
15 CM - Ø 5 IN<sup>7/8</sup>

**235693**  
15 CM - Ø 5 IN<sup>7/8</sup>



**MUG 194461**  
MUG 33 CL - 11 OZ<sup>3/16</sup>

**184083**  
33 CL - 11 OZ<sup>3/16</sup>

**246746**  
33 CL - 11 OZ<sup>3/16</sup>

**184096**  
33 CL - 11 OZ<sup>3/16</sup>

**246420**  
33 CL - 11 OZ<sup>3/16</sup>



# MODULO NATURE

---

Alldaydining

Grès

Stoneware





# LE VERRE

## Glassware

Les collections de verres DEGRENNÉ invitent au partage et à la dégustation. Leurs qualités esthétiques ainsi que leur résistance exceptionnelle, garantissent une utilisation en toute occasion. Pour compléter harmonieusement la table, les verres de couleur DEGRENNÉ, teintés dans la masse, offrent une esthétique et une qualité à l'épreuve du temps et des lavages au lave-vaisselle.

DEGRENNÉ'S glassware collections are an invitation to socialize and enjoy a drink. Our glassware's looks and exceptional sturdiness mean that is suitable for any occasion. DEGRENNÉ's integrally dyed glasses are a harmonious addition to the dining table and offer looks and quality that withstand the test of time and repeated washing in the dishwasher.



# LE VERRE À PIED

Stemmed glass



**FLÛTE 242793**  
**À CHAMPAGNE** 26,1 CL  
 CHAMPAGNE 8 OZ<sup>13/16</sup>  
 FLUTE Ø 7,25 CM  
 H 24,5 CM  
 Ø 2 IN<sup>7/8</sup>  
 H 9 IN<sup>5/8</sup>



**VERRE 242792**  
**À PIED** 40,5 CL  
 STEMMED 13 OZ<sup>11/16</sup>  
 GLASS Ø 8,3 CM  
 H 24,4 CM  
 Ø 3 IN<sup>1/4</sup>  
 H 9 IN<sup>5/8</sup>



**VERRE 242791**  
**À PIED** 57 CL  
 STEMMED 19 OZ<sup>1/4</sup>  
 GLASS Ø 9,6 CM  
 H 25 CM  
 Ø 3 IN<sup>3/4</sup>  
 H 9 IN<sup>13/16</sup>



**VERRE 242790**  
**À BORDEAUX** 64,5 CL  
 BORDEAUX 21 OZ<sup>13/16</sup>  
 GLASS Ø 10,2 CM  
 H 25,5 CM  
 Ø 4 IN  
 H 10 IN<sup>1/16</sup>



**VERRE 242789**  
**À BOURGOGNE** 71 CL  
 BURGUNDY 24 OZ  
 GLASS Ø 11,6 CM  
 H 24,5 CM  
 Ø 4 IN<sup>9/16</sup>  
 H 9 IN<sup>5/8</sup>



**GOBELET 242795**  
**HAUT** 39 CL - 13 OZ<sup>3/16</sup>  
 HIGH Ø 7 X H 14,4 CM  
 TUMBLER Ø 2 IN<sup>3/4</sup> X H 5 IN<sup>11/16</sup>



**GOBELET 242794**  
**BAS** 47 CL - 15 OZ<sup>7/8</sup>  
 LOW Ø 9,15 X H 10,85 CM  
 TUMBLER Ø 3 IN<sup>5/8</sup> X H 4 IN<sup>1/4</sup>

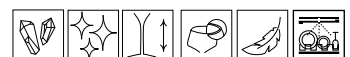



# ALLURE

Finedining

MADE IN EUROPE 



L'abus d'alcool est dangereux pour la santé  
Alcohol abuse is dangerous for your health



**FLÛTE 184567**  
**À CHAMPAGNE** 15 CL  
 CHAMPAGNE 5 OZ<sup>1/16</sup>  
 FLUTE Ø 6,3 CM  
 H 19,3 CM  
 Ø 2 IN<sup>1/2</sup>  
 H 7 IN<sup>5/8</sup>



**VERRE 184597**  
**À CHAMPAGNE** 21 CL  
 CHAMPAGNE 7 OZ<sup>1/8</sup>  
 GLASS Ø 6,8 CM  
 H 20,5 CM  
 Ø 2 IN<sup>11/16</sup>  
 H 8 IN<sup>1/16</sup>



**COUPE 210281**  
**À CHAMPAGNE** 23 CL  
 CHAMPAGNE 7 OZ<sup>3/4</sup>  
 GLASS Ø 9,5 CM  
 H 14,7 CM  
 Ø 3 IN<sup>3/4</sup>  
 H 5 IN<sup>13/16</sup>



**VERRE 195628**  
**À MARTINI** 25 CL  
 MARTINI GLASS 8 OZ<sup>7/16</sup>  
 Ø 10,6 CM  
 H 16,8 CM  
 Ø 4 IN<sup>3/16</sup>  
 H 6 IN<sup>5/8</sup>



**VERRE 184570**  
**À COGNAC** 61 CL  
 COGNAC 20 OZ<sup>5/8</sup>  
 GLASS Ø 10,4 CM  
 H 15,5 CM  
 Ø 4 IN<sup>1/8</sup>  
 H 6 IN<sup>1/8</sup>

## ORIGINE

POUR LES VINS MOELLEUX ET LIQUOREUX  
 FOR SWEET & SYRUPY WINES  
 PARA LOS VINOS MELOSOS  
 Y LICOROSOS



**VERRE N°5 216734\***  
 GLASS 20 CL  
 6 OZ<sup>3/4</sup>  
 Ø 6,9 CM  
 H 20 CM  
 Ø 2 IN<sup>11/16</sup>  
 H 7 IN<sup>7/8</sup>

\*Arrêt à épuisement des stocks  
 Until stock limited



# ANYTIME

Finedining

MADE IN EUROPE 



L'abus d'alcool est dangereux pour la santé  
Alcohol abuse is dangerous for your health



**FLÛTE À 184566**  
CHAMPAGNE 19 CL  
CHAMPAGNE 6 OZ<sup>7/16</sup>  
FLUTE Ø 5,3 CM  
H 21,9 CM  
Ø 2 IN<sup>1/16</sup>  
H 8 IN<sup>5/8</sup>



**VERRE 184562**  
**À VIN ROUGE** 37 CL  
RED WINE 12 OZ<sup>1/2</sup>  
GLASS Ø 7,7 CM  
H 21,4 CM  
Ø 3 IN<sup>1/16</sup>  
H 8 IN<sup>7/16</sup>



**VERRE 184561**  
**À EAU** 49,5 CL  
WATER 16 OZ<sup>3/4</sup>  
GLASS Ø 8,6 CM  
H 22,7 CM  
Ø 3 IN<sup>3/8</sup>  
H 8 IN<sup>15/16</sup>



**VERRE 184564**  
**À BORDEAUX** 65 CL  
BORDEAUX 22 OZ  
GLASS Ø 9,4 CM  
H 23,9 CM  
Ø 3 IN<sup>11/16</sup>  
H 9 IN<sup>7/16</sup>



**VERRE 184565**  
**À BOURGOGNE** 75 CL  
BURGUNDY 25 OZ<sup>3/8</sup>  
GLASS Ø 10,7 CM  
H 22,5 CM  
Ø 4 IN<sup>3/16</sup>  
H 8 IN<sup>7/8</sup>



DOMAINE

Finedining

MADE IN EUROPE





**FLÛTE 184556**  
**À CHAMPAGNE** 20 CL - 6 OZ<sup>3/4</sup>  
CHAMPAGNE Ø 6,7 X H 21,2 CM  
FLUTE Ø 2 IN<sup>5/8</sup> X H 8 IN<sup>3/8</sup>



**VERRE 190537**  
**À VIN** 35 CL - 11 OZ<sup>3/16</sup>  
WINE GLASS Ø 7,8 X H 19,6 CM  
Ø 3 IN<sup>1/16</sup> X H 7 IN<sup>11/16</sup>



**VERRE 190536**  
**À EAU** 45 CL - 15 OZ<sup>2/16</sup>  
WATER GLASS Ø 8,4 X H 20,5 CM  
Ø 3 IN<sup>5/16</sup> X H 8 IN<sup>1/16</sup>

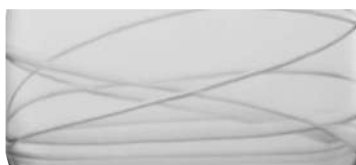

**Décor taillé dans le verre**  
Cut-glass design



**GOBELET 190538**  
TUMBLER 47 CL - 15 OZ<sup>7/8</sup>  
Ø 8,5 X H 12,1 CM  
Ø 3 IN<sup>3/8</sup> X H 4 IN<sup>3/4</sup>



# GALATEE

Finedining

MADE IN EUROPE 





**FLÛTE 184580**  
**À CHAMPAGNE** 21 CL  
 CHAMPAGNE 7 OZ<sup>1/8</sup>  
 FLUTE Ø 7 CM  
 H 21 CM  
 Ø 2 IN<sup>3/4</sup>  
 H 8 IN<sup>1/4</sup>



**VERRE 184577**  
**À VIN BLANC** 25 CL  
 WHITE WINE 8 OZ<sup>7/16</sup>  
 GLASS Ø 7,5  
 H 18,4 CM  
 Ø 2 IN<sup>15/16</sup>  
 H 7 IN<sup>1/4</sup>



**VERRE 184576**  
**À VIN ROUGE** 32 CL  
 RED WINE 10 OZ<sup>13/16</sup>  
 GLASS Ø 7,8 CM  
 H 19,8 CM  
 Ø 3 IN<sup>1/16</sup>  
 H 7 IN<sup>13/16</sup>



**VERRE 184575**  
**À EAU** 42 CL  
 WATER GLASS 14 OZ<sup>3/16</sup>  
 Ø 8,7 CM  
 H 20,5 CM  
 Ø 3 IN<sup>7/16</sup>  
 H 8 IN<sup>1/16</sup>



**VERRE 184579**  
**À BOURGOGNE** 58 CL  
 BURGUNDY GLASS 19 OZ<sup>5/8</sup>  
 Ø 10 CM  
 H 20 CM  
 Ø 3 IN<sup>15/16</sup>  
 H 7 IN<sup>7/8</sup>

MONTMARTRE  
 JAUGÉ



**VERRE 208481**  
**À VIN ROUGE** 32 CL - 10 OZ<sup>13/16</sup>  
**AVEC** Ø 7,8 X H 19,8 CM  
**DOUBLE JAUGE** Ø 3 IN<sup>1/16</sup> X H 7 IN<sup>13/16</sup>  
 RED WINE GLASS  
 WITH 2 GAUGES

HYPNOTIC  
 JAUGÉ



**213816**  
 36,5 CL - 13 OZ  
 Ø 8,2 X H 22 CM  
 Ø 3 IN<sup>1/4</sup> X H 8 IN<sup>11/16</sup>

**Avec double jauge**  
 With 2 gauges

• ..... 14 CL - 4 OZ<sup>3/4</sup>  
 • ..... 12,5 CL - 4 OZ<sup>1/4</sup>





# MONTMARTRE

Alldaydining



L'abus d'alcool est dangereux pour la santé  
Alcohol abuse is dangerous for your health



**FLÛTE À 184551**  
**CHAMPAGNE** 19 CL  
 CHAMPAGNE 6 OZ<sup>7/16</sup>  
 FLUTE Ø 6,3 CM  
 H 22,4 CM  
 Ø 2 IN<sup>1/2</sup>  
 H 8 IN<sup>13/16</sup>



**VERRE 184549**  
**À VIN BLANC** 28 CL  
 WHITE WINE 9 OZ<sup>7/16</sup>  
 GLASS Ø 7,4 CM  
 H 20,8 CM  
 Ø 2 IN<sup>15/16</sup>  
 H 8 IN<sup>3/16</sup>



**VERRE 184548**  
**À VIN ROUGE** 35 CL  
 RED WINE 11 OZ<sup>13/16</sup>  
 GLASS Ø 8 CM  
 H 21,4 CM  
 Ø 3 IN<sup>1/8</sup>  
 H 8 IN<sup>7/16</sup>



**VERRE 184547**  
**À EAU** 45 CL  
 WATER 15 OZ<sup>3/16</sup>  
 GLASS Ø 8,4 CM  
 H 22,5 CM  
 Ø 3 IN<sup>5/16</sup>  
 H 8 IN<sup>1/16</sup>



**VERRE 184550**  
**À BORDEAUX** 64,5 CL  
 BORDEAUX 21 OZ<sup>13/16</sup>  
 GLASS Ø 9,5 CM  
 H 23,8 CM  
 Ø 3 IN<sup>3/4</sup>  
 H 9 IN<sup>3/8</sup>



**VERRE 210812**  
**À BOURGOGNE** 70 CL  
 BURGUNDY 23 OZ<sup>11/16</sup>  
 GLASS Ø 10,5 CM  
 H 23,1 CM  
 Ø 4 IN<sup>1/8</sup>  
 H 9 IN<sup>1/8</sup>



**GOBELET 184555**  
**HAUT** 36 CL - 12 OZ<sup>3/16</sup>  
 HIGH Ø 6,8 X H 14,2 CM  
 TUMBLER Ø 2 IN<sup>11/16</sup> X H 5 IN<sup>9/16</sup>



**GOBELET 184554**  
**BAS** 33 CL - 11 OZ<sup>3/16</sup>  
 LOW Ø 8 X H 10,2 CM  
 TUMBLER Ø 3 IN<sup>1/8</sup> X H 4 IN

**184553**  
 23 CL - 7 OZ<sup>3/4</sup>  
 Ø 7,6 X H 9,2 CM  
 Ø 3 IN X H 3 IN<sup>5/8</sup>



# MUSE

Finedining

MADE IN EUROPE 



L'abus d'alcool est dangereux pour la santé  
Alcohol abuse is dangerous for your health



**CARAFE 242961\***  
 CARAFE 25 CL - 8 OZ<sup>7/16</sup>  
 18 CM  
 7 IN<sup>1/16</sup>

\*Arrêt à épuisement des stocks  
 Until stock limited



**COUPE À GLACE/ 244053\***  
**COCKTAIL** 28 CL  
 COCKTAIL/ICE 9 OZ<sup>7/16</sup>  
 CUP GLASS Ø 11,3 CM  
 H 14,4 CM  
 Ø 4 IN<sup>7/16</sup>  
 H 5 IN<sup>11/16</sup>



**VERRE 244055\***  
**À LIQUEUR** 7,5 CL  
 BURGUNDY 2 OZ<sup>9/16</sup>  
 GLASS Ø 7,1 CM  
 H 11 CM  
 Ø 2 IN<sup>13/16</sup>  
 H 4 IN<sup>5/16</sup>



**CARAFE 244910\***  
 CARAFE 100 CL - 33 OZ<sup>13/16</sup>  
 Ø 8,8 X H 28,3 CM  
 Ø 3 IN<sup>7/16</sup> X H 11 IN<sup>1/8</sup>



**VERRINE 244047\***  
**APÉRITIF** 27 CL - 9 OZ<sup>1/8</sup>  
 VERRINE Ø 9,3 X H 6 CM  
 APPETIZER Ø 3 IN<sup>11/16</sup> X H 2 IN<sup>3/8</sup>



**GOBELET 244061\***  
**HAUT** 37 CL - 12 OZ<sup>1/2</sup>  
 HIGH Ø 6,5 X H 16 CM  
 DRINK Ø 2 IN<sup>9/16</sup> X H 6 IN<sup>5/16</sup>

\*Arrêt à épuisement des stocks  
 Until stock limited



# NEWPORT TWIST

Finedining

MADE IN EUROPE



L'abus d'alcool est dangereux pour la santé  
Alcohol abuse is dangerous for your health



The image features four pieces of clear glassware with a textured, pebbled surface. On the left is a tall, slender tumbler. To its right is a shorter, wider tumbler. In the foreground on the right is a carafe with a flared base. A fourth piece is partially visible at the top left. The items are set against a plain white background with soft shadows cast to the right.

**GOBELET ET CARAFE**

Tumbler & Carafe

ROUGE  
RED



**GOBELET** **225516**  
TUMBLER 29 CL - 9 OZ<sup>13/16</sup>  
Ø 7,2 X H 9,5 CM  
Ø 2 IN<sup>13/16</sup> X H 3 IN<sup>3/4</sup>

NOIR  
BLACK



**180936**  
29 CL - 9 OZ<sup>13/16</sup>  
Ø 7,2 X H 9,5 CM  
Ø 2 IN<sup>13/16</sup> X H 3 IN<sup>3/4</sup>

CASSIS  
PURPLE



**174510**  
29 CL - 9 OZ<sup>13/16</sup>  
Ø 7,2 X H 9,5 CM  
Ø 2 IN<sup>13/16</sup> X H 3 IN<sup>3/4</sup>

TRANSPARENT  
TRANSPARENT



**206936**  
29 CL - 9 OZ<sup>13/16</sup>  
Ø 7,2 X H 9,5 CM  
Ø 2 IN<sup>13/16</sup> X H 3 IN<sup>3/4</sup>

GRIS  
GREY



**225517**  
29 CL - 9 OZ<sup>13/16</sup>  
Ø 7,2 X H 9,5 CM  
Ø 2 IN<sup>13/16</sup> X H 3 IN<sup>3/4</sup>

BLEU NUIT  
BLUE NIGHT



**199461**  
29 CL - 9 OZ<sup>13/16</sup>  
Ø 7,2 X H 9,5 CM  
Ø 2 IN<sup>13/16</sup> X H 3 IN<sup>3/4</sup>

BLANC  
WHITE



**180939**  
29 CL - 9 OZ<sup>13/16</sup>  
Ø 7,2 X H 9,5 CM  
Ø 2 IN<sup>13/16</sup> X H 3 IN<sup>3/4</sup>

VERRE SOUFLÉ BOUCHE TEINTÉ DANS LA MASSE  
HAND-BLOWN INTEGRALLY DYED GLASS





# ALLEGRO

Alldaydining



L'abus d'alcool est dangereux pour la santé  
Alcohol abuse is dangerous for your health



**GOBELET 184589**  
**HAUT** 35 CL - 11 OZ<sup>13/16</sup>  
 HIGH Ø 6,5 X H 14,4 CM  
 TUMBLER Ø 2 IN<sup>9/16</sup> X H 5 IN<sup>11/16</sup>



**GOBELET 184588**  
**HAUT** 29 CL - 9 OZ<sup>13/16</sup>  
 HIGH Ø 7 X H 10,7 CM  
 TUMBLER Ø 2 IN<sup>3/4</sup> X H 4 IN<sup>3/16</sup>



**GOBELET 189774**  
**BAS** 42 CL - 14 OZ<sup>3/16</sup>  
 LOW Ø 8,5 X H 10,6 CM  
 TUMBLER Ø 3 IN<sup>3/8</sup> X H 4 IN<sup>3/16</sup>



**GOBELET 184586**  
**BAS** 32 CL - 10 OZ<sup>13/16</sup>  
 LOW Ø 8 X H 9,4 CM  
 TUMBLER Ø 3 IN<sup>1/8</sup> X H 3 IN<sup>11/16</sup>



**GOBELET 169851**  
**HAUT** 57 CL - 19 OZ<sup>1/4</sup>  
 HIGH Ø 6,7 X H 11,5 CM  
 TUMBLER Ø 2 IN<sup>5/8</sup> X H 4 IN<sup>1/2</sup>



**GOBELET 169852**  
**BAS** 43 CL - 14 OZ<sup>9/16</sup>  
 LOW Ø 6,1 X H 10 CM  
 TUMBLER Ø 2 IN<sup>3/8</sup> X H 3 IN<sup>15/16</sup>



# COSMOPOLITAIN

Alldaydining

MADE IN EUROPE



# DOLCE

Finedining



TRANSPARENT  
TRANSPARENT



**VERRE 234149**  
**À PIED** 26 CL - 8 OZ<sup>13/16</sup>  
STEMMED Ø 7,9 X H 11,1 CM  
GLASS Ø 3 IN<sup>1/8</sup> X H 4 IN<sup>3/8</sup>

BLEU  
BLUE



**236287**  
26 CL - 8 OZ<sup>13/16</sup>  
Ø 7,9 X H 11,1 CM  
Ø 3 IN<sup>1/8</sup> X H 4 IN<sup>3/8</sup>

GRIS  
GREY



**242555**  
26 CL - 8 OZ<sup>13/16</sup>  
Ø 7,9 X H 11,1 CM  
Ø 3 IN<sup>1/8</sup> X H 4 IN<sup>3/8</sup>

VERT  
GREEN



**GOBELET 234150**  
TUMBLER 26 CL - 8 OZ<sup>13/16</sup>  
Ø 7,1 X H 9,1 CM  
Ø 2 IN<sup>13/16</sup> X H 3 IN<sup>9/16</sup>



**236289**  
26 CL - 8 OZ<sup>13/16</sup>  
Ø 7,1 X H 9,1 CM  
Ø 2 IN<sup>13/16</sup> X H 3 IN<sup>9/16</sup>



**242554**  
26 CL - 8 OZ<sup>13/16</sup>  
Ø 7,1 X H 9,1 CM  
Ø 2 IN<sup>13/16</sup> X H 3 IN<sup>9/16</sup>



**242552**  
26 CL - 8 OZ<sup>13/16</sup>  
Ø 7,1 X H 9,1 CM  
Ø 2 IN<sup>13/16</sup> X H 3 IN<sup>9/16</sup>



**CARAFE 234148**  
**EMPILEO** 75 CL - 25 OZ<sup>3/8</sup>  
PITCHER Ø 9,1 X H 24 CM  
Ø 3 IN<sup>9/16</sup> X H 4 IN<sup>3/8</sup>



**236288**  
75 CL - 25 OZ<sup>3/8</sup>  
Ø 9,1 X H 24 CM  
Ø 3 IN<sup>9/16</sup> X H 4 IN<sup>3/8</sup>



# EMPILEO

Alldaydining



L'abus d'alcool est dangereux pour la santé  
Alcohol abuse is dangerous for your health

# INSTANT

Alldaydining



**243495\***  
32 CL - 10 OZ<sup>13/16</sup>  
Ø 6 X H 13,7 CM  
Ø 2 IN<sup>3/8</sup> X H 5 IN<sup>3/8</sup>

\*Arrêt à épuisement des stocks  
Until stock limited



# LOOP

Alldaydining



**GOBELET 184601**  
**HAUT** 39 CL - 13 OZ<sup>3/16</sup>  
HIGH Ø 6,6 X H 14,5 CM  
TUMBLER Ø 2 IN<sup>5/8</sup> X H 5 IN<sup>11/16</sup>



**GOBELET 184600**  
**BAS** 35 CL - 11 OZ<sup>13/16</sup>  
LOW Ø 7,9 X H 9,1 CM  
TUMBLER Ø 3 IN<sup>1/8</sup> X H 3 IN<sup>9/16</sup>



**GOBELET BAS/ 184598**  
**VERRINE** 19 CL - 6 OZ<sup>7/16</sup>  
LOW TUMBLER/ Ø 6,7 X H 8,1 CM  
APPETIZER GLASS Ø 2 IN<sup>5/8</sup> X H 3 IN<sup>3/16</sup>



# MAMBO

Alldaydining

GRIS  
GREY



**GOBELET 171631**  
TUMBLER 34 CL - 11 OZ<sup>1/2</sup>  
Ø 8,5 X H 10 CM  
Ø 3 IN<sup>3/8</sup> X H 3 IN<sup>15/16</sup>

VERT  
GREEN



**171632**  
34 CL - 11 OZ<sup>1/2</sup>  
Ø 8,5 X H 10 CM  
Ø 3 IN<sup>3/8</sup> X H 3 IN<sup>15/16</sup>

ROUGE  
RED



**171630**  
34 CL - 11 OZ<sup>1/2</sup>  
Ø 8,5 X H 10 CM  
Ø 3 IN<sup>3/8</sup> X H 3 IN<sup>15/16</sup>



# ROC

Alldaydining



**VERRE 236340**  
À PIED 27 CL - 9 OZ<sup>1/8</sup>  
STEMMED Ø 7,2 X H 11,5 CM  
GLASS Ø 3 IN<sup>13/16</sup> X H 4 IN<sup>1/2</sup>



**GOBELET 236338**  
BAS 18 CL - 6 OZ<sup>1/16</sup>  
LOW Ø 7,2 X H 6,5 CM  
TUMBLER Ø 2 IN<sup>13/16</sup> X H 2 IN<sup>3/8</sup>



**GOBELET 236339**  
HAUT 45 CL - 15 OZ<sup>3/16</sup>  
HIGH Ø 7,2 X H 14 CM  
TUMBLER Ø 2 IN<sup>13/16</sup> X H 5 IN<sup>1/2</sup>



TRANSPARENT  
TRANSPARENT



**CARAFE 234148**  
**EMPILEO** 75 CL - 25 OZ<sup>3/8</sup>  
PITCHER Ø 9,1 X H 24 CM  
Ø 3 IN<sup>9/16</sup> X H 4 IN<sup>3/8</sup>

BLEU  
BLUE



**236288**  
75 CL - 25 OZ<sup>3/8</sup>  
Ø 9,1 X H 24 CM  
Ø 3 IN<sup>9/16</sup> X H 4 IN<sup>3/8</sup>



**CARAFE À JUS 202639**  
**DE FRUITS** 1,2 L - 40 OZ<sup>9/16</sup>  
**EVENTO** Ø 10,5 X H 27,5 CM  
JUICE/ Ø 4 IN<sup>1/8</sup> X H 10 IN<sup>13/16</sup>  
BEVERAGE  
CARAFE



**BOUCHON DE 202855**  
**CARAFE** Ø 6,5 CM - 2 IN<sup>9/16</sup>  
**SILICONE**  
**EVENTO**  
SILICONE  
STOPPER  
FOR CARAFE



**CARAFE 242961\***  
**NEWPORT TWIST** 25 CL - 8 OZ<sup>7/16</sup>  
CARAFE 18 CM  
7 IN<sup>1/16</sup>



**CARAFE 244910\***  
**NEWPORT** 100 CL - 33 OZ<sup>13/16</sup>  
**TWIST** Ø 8,8 X H 28,3 CM  
CARAFE Ø 3 IN<sup>7/16</sup> X H 11 IN<sup>1/8</sup>



**DECANTEUR 169728**  
**MILLÉSIME** 1,35 L - 45 OZ<sup>5/8</sup>  
DECANTER Ø 20,5 X H 23,5 CM  
Ø 8 IN<sup>1/16</sup> X H 9 IN<sup>1/4</sup>



**DECANTEUR 210904**  
**NECTAR** 1 L - 33 OZ<sup>13/16</sup>  
DECANTER Ø 13,5 X H 24,5 CM  
Ø 5 IN<sup>5/16</sup> X H 9 IN<sup>5/8</sup>

\*Arrêt à épuisement des stocks  
Until stock limited





# CARAFES - DÉCANTEURS

---





# LA PLATERIE

Holloware

A travers des objets en acier dédiés à la table, au service et à la dégustation, DEGRENNE exprime à travers ses collections de platerie toute la richesse de son métier d'orfèvre.

DEGRENNE expresses its highly-varied metal-working expertise through steel products designed for the table, service and tasting and appreciating.

PLATEAUX EMPILABLES  
STACKABLE SERVING TRAYS



**PLATEAUX** ✱ **238953**  
**RECTANGULAIRES** 📏 **238963**  
**AVEC ANSES** EXT : 77 X 55 CM - 30 IN<sup>5/16</sup> X 21 IN<sup>5/8</sup>  
RECTANGULAR INT : 68,5 X 46,5 CM - 26 IN<sup>15/16</sup> X 18 IN<sup>5/16</sup>  
SERVING TRAYS

WITH HANDLES

✱ **238954**  
📏 **238964**  
**GASTRONORM 2/1**  
EXT : 65 X 53 CM - 25 IN<sup>9/16</sup> X 20 IN<sup>7/8</sup>  
INT : 56,5 X 44,5 CM - 22 IN<sup>1/4</sup> X 17 IN<sup>1/2</sup>

✱ **238955**  
📏 **238965**  
EXT : 60 X 40 CM - 23 IN<sup>5/8</sup> X 15 IN<sup>3/4</sup>  
INT : 51,5 X 31,5 CM - 20 IN<sup>1/4</sup> X 12 IN<sup>3/8</sup>



**PLATEAUX** ✱ **238962**  
**RECTANGULAIRES** 📏 **238970**  
**SANS ANSES** **GASTRONORM 1/1**  
RECTANGULAR EXT : 53 X 32,5 CM - 20 IN<sup>7/8</sup> X 12 IN<sup>13/16</sup>  
SERVING TRAYS INT : 46,5 X 26 CM - 18 IN<sup>5/16</sup> X 10 IN<sup>1/4</sup>  
WITHOUT HANDLES

✱ **238961**  
📏 **238971**  
EXT : 40 X 27 CM - 15 IN<sup>3/4</sup> X 10 IN<sup>5/8</sup>  
INT : 33,5 X 20,5 CM - 13 IN<sup>3/16</sup> X 8 IN<sup>1/16</sup>

✱ **238960**  
📏 **238972**  
**GASTRONORM 1/2**  
EXT : 32,5 X 26,5 CM - 12 IN<sup>13/16</sup> X 10 IN<sup>7/16</sup>  
INT : 26 X 20 CM - 10 IN<sup>1/4</sup> X 7 IN<sup>7/8</sup>

✱ **227767**  
📏 **227768**  
EXT : 22 X 14 CM - 8 IN<sup>11/16</sup> X 5 IN<sup>1/2</sup>  
INT : 20 X 12 CM - 7 IN<sup>7/8</sup> X 4 IN<sup>3/4</sup>



**PLATEAU ROND** ✱ **185024**  
ROUND TRAY 📏 **186457**  
EXT : 42 CM - 16 IN<sup>9/16</sup>  
INT : 35,1 CM - 13 IN<sup>13/16</sup>

**NORMANDY**



**PLATEAU** ✱ **232972**  
**RECTANGULAIRE** INT : 26 X 18 CM - 10 IN<sup>1/4</sup> X 7 IN<sup>1/16</sup>  
**SANS ANSES** EXT : 23 X 15 CM - 9 IN<sup>1/16</sup> X 5 IN<sup>7/8</sup>  
RECTANGULAR  
SERVING TRAY  
WITHOUT HANDLES

# NEWPORT PLATEAUX

---

Finedining



DEGRENNE  
PARIS



PLATEAUX EMPILABLES  
STACKABLE SERVING TRAYS



**PLATEAUX** ✱ **238987**  
**RECTANGULAIRES** 📏 **238989**  
**AVEC ANSES** **GASTRONORM 2/1**  
RECTANGULAR EXT : 65 X 53 CM - 25 IN<sup>9/16</sup> X 20 IN<sup>7/8</sup>  
SERVING TRAYS INT : 56,5 X 44,5 CM - 22 IN<sup>1/4</sup> X 17 IN<sup>1/2</sup>  
WITH HANDLES

✱ **238988**  
📏 **238990**  
EXT : 60 X 40 CM - 23 IN<sup>5/8</sup> X 15 IN<sup>3/4</sup>  
INT : 51,5 X 31,5 CM - 20 IN<sup>1/4</sup> X 12 IN<sup>3/8</sup>



**PLATEAUX** ✱ **211888**  
**RECTANGULAIRES** 📏 **213859**  
**SANS ANSES** **GASTRONORM 1/2**  
RECTANGULAR EXT : 32,5 X 26,5 CM - 12 IN<sup>13/16</sup> X 10 IN<sup>7/16</sup>  
SERVING TRAYS INT : 26 X 20 CM - 10 IN<sup>1/4</sup> X 7 IN<sup>7/8</sup>  
WITHOUT HANDLES

✱ **211889**  
📏 **213860**  
EXT : 22 X 14 CM - 8 IN<sup>11/16</sup> X 5 IN<sup>1/2</sup>  
INT : 20 X 12 CM - 7 IN<sup>7/8</sup> X 4 IN<sup>3/4</sup>



**DESSOUS DE** ✱ **230872**  
**BOUEILLE** 📏 **230874**  
BOTTLE 13,5 CM - 5 IN<sup>5/16</sup>  
COASTER

# NEWPORT CUBIQUE PLATEAUX

---

Finedining

  
MADE IN FRANCE





**PLATS OVALES**  
OVAL DISHES

■ 238958

■ 238968

EXT : 46 X 31 CM - 18 IN<sup>1/8</sup> X 12 IN<sup>3/16</sup>  
INT : 25,9 X 13,9 CM - 10 IN<sup>3/16</sup> X 5 IN<sup>1/2</sup>

■ 238957

■ 238967

EXT : 41 X 28 CM - 16 IN<sup>1/8</sup> X 11 IN  
INT : 28,7 X 15,6 CM - 11 IN<sup>5/16</sup> X 6 IN<sup>1/8</sup>

■ 238956

■ 238966

EXT : 38 X 25 CM - 14 IN<sup>15/16</sup> X 9 IN<sup>13/16</sup>  
INT : 26,6 X 16,3 CM - 10 IN<sup>1/2</sup> X 6 IN<sup>7/16</sup>



**PLAT À POISSON**  
FISH DISH

■ 238959

■ 238969

INT : 60 X 27 CM - 23 IN<sup>5/8</sup> X 10 IN<sup>5/8</sup>  
EXT : 46,3 X 14,3 CM - 18 IN<sup>1/4</sup> X 5 IN<sup>5/8</sup>



**SAUCIÈRE**  
SAUCE BOAT

■ 186198

■ 186456

19 X 7,6 CM - 20 CL  
7 IN<sup>1/2</sup> X 3 IN - 6 OZ<sup>3/4</sup>



**BEURRIER**  
BUTTER DISH

■ 185307

■ 186455

Ø 9 X 7,6 CM - 3 IN X 2 IN<sup>3/4</sup>



**PORTE SUCRE**  
**CENTRE DE TABLE**  
SUGAR HOLDER/TABLE

■ 211397

Ø 6,4 X H 6 CM - Ø 2 IN<sup>1/2</sup> X H 2 IN<sup>3/8</sup>



**SOCLE BEURRIER**  
**PORCELAINE**  
BUTTER DISH  
BASE PORCELAIN

190255

Ø 9 X 7,6 CM - 3 IN X 2 IN<sup>3/4</sup>



# NEWPORT TABLE

Finedining



MADE IN FRANCE





**VERSEUSES**  
COFFEE/TEA POTS

★ **213850**  
☞ **219563**  
1,5 L - 18,1 CM X H 22,4 CM  
50 OZ<sup>3/4</sup> - 7 IN<sup>1/8</sup> X H 8 IN<sup>3/16</sup>

★ **213851**  
☞ **219564**  
70 CL - 14,8 CM X H 14,6 CM  
23 OZ<sup>11/16</sup> - 5 IN<sup>13/16</sup> X H 5 IN<sup>3/4</sup>

★ **213852**  
☞ **219565**  
35 CL - 12,9 CM X H 9,3 CM  
11 OZ<sup>13/16</sup> - 5 IN<sup>1/16</sup> X H 3 IN<sup>11/16</sup>



**PICHET**  
JUG

★ **213849**  
☞ **219561**  
2 L - 18,1 CM X H 23 CM  
67 OZ<sup>5/8</sup> - 7 IN<sup>1/8</sup> X H 9 IN<sup>1/16</sup>



**POTS ISOTHERMES**  
INSULATED POTS

★ **213846**  
☞ **219557**  
1,2 L - 18,1 CM X H 22,7 CM  
40 OZ<sup>9/16</sup> - 7 IN<sup>1/8</sup> X H 8 IN<sup>15/16</sup>

★ **213847**  
☞ **219558**  
70 CL - 15,6 CM X H 19,2 CM  
23 OZ<sup>11/16</sup> - 6 IN<sup>1/8</sup> X H 7 IN<sup>9/16</sup>

★ **213848**  
☞ **219559**  
30 CL - 13,4 CM X H 12,7 CM  
40 OZ - 5 IN<sup>1/4</sup> X H 5 IN



**CRÉMIERS**  
CREAM JUGS

★ **213853**  
☞ **219566**  
35 CL - 12,9 CM X H 9 CM  
11 OZ<sup>13/16</sup> - 5 IN<sup>1/16</sup> X H 3 IN<sup>9/16</sup>

★ **213854**  
☞ **219567**  
15 CL - 9 CM X H 9 CM  
5 OZ<sup>1/16</sup> - 3 IN<sup>9/16</sup> X H 3 IN<sup>9/16</sup>



**SUCRIER**  
SUGAR BOWL

★ **182341**  
☞ **184612**  
35 CL  
11 OZ<sup>13/16</sup>



**NEWPORT**  
P. 182

# NEWPORT CAFÈTERIE

---

Finedining





**SEAU À CHAMPAGNE** ✱ 184180  
**2 BOUTEILLES** 188895  
 CHAMPAGNE BUCKET Ø 24 X H 25,5 CM  
 2 BOTTLES Ø 9 IN<sup>7/16</sup> X H 10 IN<sup>1/16</sup>



**SEAU À GLACE** ✱ 184181  
**AVEC COUVERCLE** 188896  
 ICE BUCKET Ø 15 X H 16 CM  
 WITH LID Ø 5 IN<sup>7/8</sup> X H 6 IN<sup>5/16</sup>

**SEAU À CHAMPAGNE** ✱ 186030  
**1 BOUTEILLE** 188894  
 CHAMPAGNE BUCKET Ø 20 X H 22,5 CM  
 1 BOTTLE Ø 7 IN<sup>7/8</sup> X H 8 IN<sup>2/8</sup>



**RAFRAICHISSEUR** ✱ 237501  
**DROIT DOUBLE PAROI** Ø 13,9 X H 19,8 CM  
 CURVED DOUBLE Ø 5 IN<sup>1/2</sup> X H 7 IN<sup>13/16</sup>  
 WALL WINE COOLER

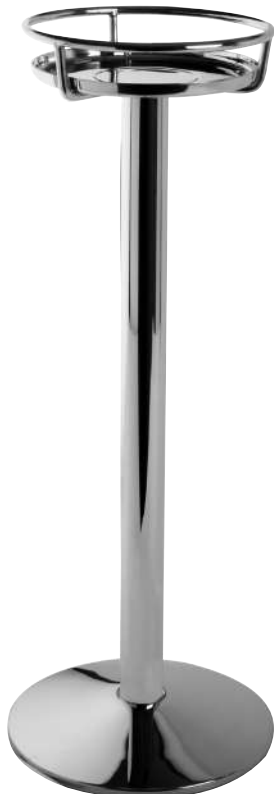

**PORTE SEAU** ✱ 185607  
**À CHAMPAGNE** 188893  
**(1 OU 2 BOUTEILLES)** H 63,5 CM - 25 IN  
 CHAMPAGNE  
 BUCKET STAND  
 (1 OR 2 BOTTLES)



**DESSOUS DE BOUTEILLE** ✱ 234320  
 BOTTLE COASTER 9,5 CM - 3 IN<sup>3/4</sup>  
 NEWPORT LOUNGE



**PINCE À GLACE** ✱ 004014  
 ICE TONG 16 CM  
 6 IN<sup>5/16</sup>

# NEWPORT BAR

---

Alldaydining





**CLOCHE ASSIETTE**  
DOME COVER  
INOX STAINLESS STEEL  
\* 182614  
184477  
Ø 24 CM - 9 IN<sup>7/16</sup>

\* 182301  
184476  
Ø 14,8 CM - 5 IN<sup>13/16</sup>



**CLOCHE**  
INOX STAINLESS STEEL  
\* 044113  
101512  
Ø 26 CM - 10 IN<sup>1/4</sup>

\* 044112  
101510  
22 CM - 8 IN<sup>7/8</sup>



**CLOCHE EVENTO VERRE**  
DOME COVER  
239771  
Ø 28 CM - 11 IN  
239770  
Ø 23 CM - 9 IN<sup>1/6</sup>

239769  
Ø 16 CM - 6 IN<sup>5/16</sup>



**VERRE BOROSILICATE**  
GLASS  
204043  
17 X 9 CM - 6 IN<sup>11/16</sup> X 3 IN<sup>9/16</sup>

206504  
**BOUCHON PORCELAINE**  
PORCELAIN LID  
5,2 CM - 2 IN<sup>1/16</sup>



**CORBEILLE RONDE À PAIN**  
BREAD BASKET  
ROUND  
\* 128910  
131114  
Ø 17,5 X H 6 CM  
Ø 6 IN<sup>7/8</sup> X H 2 IN<sup>3/8</sup>

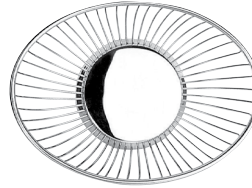

**CORBEILLE OVALE À PAIN**  
BREAD BASKET  
OVAL  
\* 128912  
131117  
Ø 24 X 17 CM - H 7,5 CM  
Ø 9 IN<sup>7/16</sup> X 6 IN<sup>11/16</sup> - H 2 IN<sup>15/16</sup>

\* 128911  
131118  
Ø 20 X 15 CM - H 6 CM  
Ø 7 IN<sup>7/8</sup> X 5 IN<sup>7/8</sup> - H 2 IN<sup>3/8</sup>



**VERRINE SEL/POIVRE AIMANTÉE**  
SALT & PEPPER CELLAR W/MAGNET  
216920  
POIVRE/PEPPER  
216919  
SEL/SALT  
4,1 X 6,7 CM  
1 IN<sup>5/8</sup> X 2 IN<sup>5/8</sup>

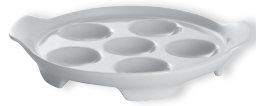

**PLAT À ESCARGOTS PORCELAINE**  
SNAIL TONG  
164138  
Ø 16,6 CM - 6 IN<sup>9/16</sup>



**ENSEMBLE SEL/POIVRE AIMANTÉE**  
SALT & PEPPER CELLAR W/MAGNET  
216922  
8,5 X 10,6 CM  
3 IN<sup>3/8</sup> X 4 IN<sup>3/16</sup>



**PINCE À ESCARGOTS**  
SNAIL TONG  
\* 004013  
16 CM - 6 IN<sup>5/16</sup>



**CISEAUX À GÂTEAUX**  
PASTRY SCISSORS/TONG  
\* 204496  
101494  
20 CM - 7 IN<sup>7/8</sup>



**PINCE À PAIN BREAD TONG**  
\* 204498  
101492  
23 CM - 9 IN<sup>1/16</sup>



**PINCE À CRUSTACÉS SEAFOOD/CRAKER**  
\* 184492  
16,5 CM - 6 IN<sup>1/2</sup>



**PINCE À SERVIR SERVING TONG**  
\* 204499  
184355  
29,5 CM - 11 IN<sup>5/8</sup>



# NEWPORT ACCESSOIRES

Alldaydining

MADE IN EUROPE







# LE BUFFET EVENTO

## EVENTO BUFFET

Du petit-déjeuner au dîner, des buffets sucrés aux buffets salés, la collection EVENTO répond à tous les scénarios de réception tout en assurant une hygiène parfaite pour satisfaire au mieux les nouvelles exigences de vos clients.

Le buffet EVENTO au design homogène, harmonieux, fonctionnel et modulable, dispose de nombreux produits qui évitent d'exposer le contenu à l'air libre tout en conservant les aliments au frais comme au chaud et qui peuvent être utilisés pour la majorité en portion individuelle ou à usage unique. La richesse de ses combinaisons et la diversité de ses matériaux (acier, porcelaine, verre, grès, mélamine pierre et bois etc...) s'adaptent à votre style et à la dimension de votre établissement. La collection EVENTO valorise avec une touche de chic la mise en scène de vos buffets, selon le moment de la journée, de la saison...

From breakfast to dinner, from sweet buffets to savoury spreads, the EVENTO collection works for all your reception needs while ensuring perfect hygiene to best meet the new requirements of your customers.

The EVENTO buffet with a unified, harmonious, practical and modular design has many products that will avoid exposing their contents to the open air while keeping the food cool as well as warm and which can be used for the most part in individual portions or single use. With a host of combinations and a range of materials to choose from (steel, porcelain, glass, stoneware, melamine, stone and wood...), you can find what works for your style and the size of your space. The EVENTO collection adds a chic touch to your buffet presentations to reflect the time of day or the season.

# CHAFING DISHES\*

Couvercle en verre transparent pour percevoir le contenu et rendre le buffet plus gourmand  
Clear glass cover allows contents to be viewed instantly and makes the buffet more enticing

Charnière avec vérin et amortisseur pour un réel confort d'utilisation et une fermeture en douceur  
The hydraulic buffering hinge offers user comfort and convenience with its soft closure mechanism

Encoches pour les couverts de service  
The notch for the serving cutlery



Acier inoxydable, couvercle avec gouttière, verre trempé, système de récupération d'eau de condensation  
Stainless steel, lid with groove, condensation water collection system in the porcelain insert

Compatible plaque induction, avec résistance électrique ou porte-brûleur avec gel combustible  
Compatible with induction, electrical and/or «sterno» fuel heating system



2 FINITIONS  
FINISHES



Ø 35,5 CM X P 41 CM X H 15 CM  
Ø 14 IN X D 16 IN<sup>1/8</sup> X H 5 IN<sup>7/8</sup>

\*Certaines pièces sont disponibles en pièces détachées  
Some items are available individually

# CHAFING DISHES



Le Chafing dish, par son design contemporain alliant acier, porcelaine et verre offre à votre buffet une présentation soignée et raffinée.  
The Chafing dish, with its contemporary design that combines steel, porcelain and glass, brings a smart and sophisticated touch to your buffet display.

**FINITION MIROIR**  
MIRROR FINISH



**FINITION BROSSÉE**  
BRUSHED FINISH



**CHAFING DISH 236195**  
**SANS BAC** Ø 35,5 CM - P 41 CM - H 15 CM  
**ACIER INOXYDABLE** Ø 14 IN - D 16 IN<sup>7/8</sup> - H 5 IN<sup>7/8</sup>  
**+ COUVERCLE**  
**AVEC GOUTIÈRE**  
**VERRE TREMPÉ**  
CHAFING DISH  
WITHOUT INSERT  
STAINLESS STEEL  
+ LID WITH GROOVE,  
TEMPERED GLASS

**236194**  
Ø 35,5 CM - P 41 CM - H 15 CM  
Ø 14 IN - D 16 IN<sup>7/8</sup> - H 5 IN<sup>7/8</sup>

**COUVERCLE 203470**  
**AVEC GOUTIÈRE ACIER,**  
**VERRE TREMPÉ**  
LID WITH STAINLESS STEEL  
GUTTER,  
TEMPERED GLASS

**ACIER**  
STAINLESS STEEL



**BAC POUR 216142**  
**CHAFING DISH** Ø 35,6 X H 7 CM  
**CHAFING INSERT** CONTENANCE 3L  
Ø 14 X 2 IN<sup>3/4</sup>  
CAPACITY 100 OZ

**PORCELAINE**  
PORCELAIN



**215721**  
Ø 35,6 X H 7 CM  
CONTENANCE 3L  
Ø 14 X 2 IN<sup>3/4</sup>  
CAPACITY 100 OZ



**1/2 BAC PORCELAINE 202635**  
**POUR**  
**CHAFING DISH** L 29 X L 15 X H 4,5 CM  
**CHAFING DISH** CONTENANCE 1L  
1/2 CHAFING 11 IN<sup>7/16</sup> X 5 IN<sup>7/8</sup> X 1 IN<sup>3/4</sup>  
PORCELAIN INSERT CAPACITY 33 OZ<sup>13/16</sup>



**SUPPORT CHAFING 203005**  
**ACIER INOXYDABLE** Ø 35 CM - P 40 CM - H 12,5 CM  
**POUR RÉSTANCE** Ø 13 IN<sup>3/4</sup> - D 15 IN<sup>3/4</sup> - H 4 IN<sup>15/16</sup>  
**ÉLECTRIQUE**  
**OU PORTE-BRÛLEUR**  
**AVEC GEL COMBUSTIBLE**  
CHAFING STAND  
STAINLESS STEEL,  
FOR ELECTRICAL AND/OR  
STERNO HEATING  
PURPOSES



**202859**  
Ø 35 CM - P 40 CM - H 12,5 CM  
Ø 13 IN<sup>3/4</sup> - D 15 IN<sup>3/4</sup> - H 4 IN<sup>15/16</sup>



**RÉSISTANCE 202860**  
**AVEC RÉGULATEUR** 220 /240 V /200 W  
**DE TEMPÉRATURE** 20 X 20 CM - 7 IN<sup>7/8</sup> X 7 IN<sup>7/8</sup>  
HEATING ELEMENT  
HEAT ADJUSTABLE **246341**  
500 W  
20 X 20 CM - 7 IN<sup>7/8</sup> X 7 IN<sup>7/8</sup>



**PORTE-BRÛLEUR 243950**  
**POUR GEL** Ø 9 CM - H 6 CM  
**COMBUSTIBLE ACIER** Ø 3 IN<sup>9/16</sup> X 2 IN<sup>3/8</sup>  
BURNER HOLDER STEEL

\*Certaines pièces sont disponibles en pièces détachées  
Some items are available individually

\*À commander obligatoirement avec le bac pour chafing dish (216142 ou 215721)  
Must be ordered with the chafing insert (216142 or 215721)



# REFRIGERATED UNITS\*



L 56,5 CM X P 36 CM X H 9,5 CM  
22 IN<sup>1/4</sup> X D 14 IN<sup>3/16</sup> X 3 IN<sup>3/4</sup>

**FINITION MIROIR**  
MIRROR FINISH



**MODULE ACIER 202864**  
+ BAC PLASTIQUE<sup>(1)</sup> GN1/1  
REFRIGERATED SET L 56,5 CM - P 36 CM - H 9,5 CM  
+ PLASTIC TRAY 22 IN<sup>1/4</sup> - D 14 IN<sup>3/16</sup> X 3 IN<sup>3/4</sup>

**235356**  
GN1/2  
29,5 X 35,6 CM  
11 IN<sup>5/8</sup> X 14 IN

**FINITION BROSSÉE**  
BRUSHED FINISH



**202865**  
GN1/1  
L 56,5 CM - P 36 CM - H 9,5 CM  
22 IN<sup>1/4</sup> - D 14 IN<sup>3/16</sup> X 3 IN<sup>3/4</sup>

**235361**  
GN1/2  
29,5 X 35,6 CM  
11 IN<sup>5/8</sup> X 14 IN

**FINITION NOIR MÉTALLISÉ**  
METALLIC BLACK FINISH



**202869**  
GN1/1  
L 56,5 CM - P 36 CM - H 9,5 CM  
22 IN<sup>1/4</sup> - D 14 IN<sup>3/16</sup> X 3 IN<sup>3/4</sup>

**235362**  
GN1/2  
29,5 X 35,6 CM  
11 IN<sup>5/8</sup> X 14 IN



**COUVERCLE 202871**  
MODULE RÉFRIGÉRÉ 56 X 35 X 19 CM  
POIGNÉE INOXYDABLE 22 IN<sup>1/16</sup> X 13 IN<sup>3/4</sup> X 7 IN<sup>1/2</sup>  
LID FOR REFRIGERATED SET/  
STAINLESS STEEL HANDLE



**PLAQUE EUTECTIQUE 208357**  
NOIRE POUR GN1/1  
MODULE FROID 48 X 28 X 3 CM  
BLACK COOLING 18 IN<sup>7/8</sup> X 11 IN X 1 IN<sup>3/16</sup>  
EUTECTIC BLOCK  
FOR UNIT

**239786**  
GN1/2  
18 X 25 CM  
7 IN<sup>18/16</sup> X 9 IN<sup>13/16</sup>

3 FINITIONS  
FINISHES

Le module réfrigéré reçoit une large gamme de contenants, plateaux et accessoires multi-matériaux au format GN en porcelaine, verre, acier, acrylique, mélamine pierre et mélamine bois. Ils permettent une infinité de combinaisons.

The refrigerated unit will hold a wide range of platters and multi-material accessories in Industry standard format in porcelain, glass, steel, acrylic stone and wood melamine allowing endless combinations.

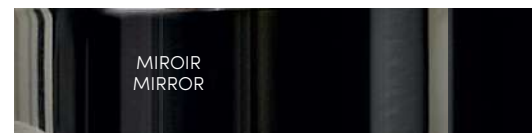

MIROIR  
MIRROR



BROSSÉ  
BRUSHED



NOIR MÉTALLISÉ  
METALLIC BLACK

\*Certaines pièces sont disponibles en pièces détachées  
Some items are available individually

(1) Garantie lave-vaisselle  
Dish washer safe

# MODULES FROIDS



**PLATEAUX POUR MODULES FROIDS**  
PLATTERS FOR REFRIGERATED UNITS

**MÉLAMINE BOIS<sup>(1)</sup>**  
WOOD MELAMINE TRAY



**PLATEAUX 234546**  
TRAYS **GN1/1**  
53 X 32,5 CM  
20 IN<sup>7/8</sup> X 12 IN<sup>13/16</sup>



**234548**  
**GN 2/3**  
35,5 X 32,5 CM  
14 IN X 12 IN<sup>13/16</sup>



**234551**  
**GN 1/2**  
26,4 X 32,5 CM  
10 IN<sup>3/8</sup> X 12 IN<sup>13/16</sup>



**234553**  
**GN 1/3**  
17,5 X 32,5 CM  
6 IN<sup>7/8</sup> X 12 IN<sup>13/16</sup>



**234557**  
**GN 1/6**  
8,7 X 32,5 CM  
3 IN<sup>7/16</sup> X 12 IN<sup>13/16</sup>

**MÉLAMINE PIERRE<sup>(1)</sup>**  
STONE MELAMINE TRAY



**234547**  
**GN1/1**  
53,5 X 32,5 CM  
20 IN<sup>7/8</sup> X 12 IN<sup>13/16</sup>



**234549**  
**GN 2/3**  
35,4 X 32,5 CM  
13 IN<sup>15/16</sup> X 12 IN<sup>13/16</sup>



**234552**  
**GN 1/2**  
26,4 X 32,5 CM  
10 IN<sup>3/8</sup> X 12 IN<sup>13/16</sup>



**234554**  
**GN 1/3**  
17,5 X 32,5 CM  
6 IN<sup>7/8</sup> X 12 IN<sup>13/16</sup>



**234558**  
**GN 1/6**  
8,7 X 32,5 CM  
3 IN<sup>7/16</sup> X 12 IN<sup>13/16</sup>

**ACIER 18/10 NEWPORT**  
**FINITION MIROIR**  
SERVING TRAY STAINLESS STEEL  
18/10 MIRROR FINISHED

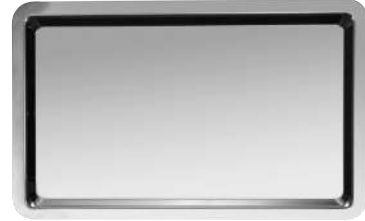

**238962**  
**GN1/1**  
53,5 X 32,5 CM  
20 IN<sup>7/8</sup> X 12 IN<sup>13/16</sup>



**238960**  
**GN 1/2**  
26,4 X 32,5 CM  
10 IN<sup>3/8</sup> X 12 IN<sup>13/16</sup>

(1) Compatible lave-vaisselle, NON compatible micro-ondes  
Dish washer safe, DONT USE with micro-wave



**VERRE ÉPAISSEUR 0,6 CM**  
TEMPERED GLASS THICKNESS 1/4"

**ACRYLIQUE ÉPAISSEUR 1 CM**  
ACRYLIC THICKNESS 3/8"

**GRÈS ONYX (2)**  
ONYX STONEWARE

**PORCELAINE (2)**  
WHITE ENAMELLED PORCELAIN



**230752**  
**GN 1/1**  
53,5 X 32,5 CM  
20 IN<sup>7/8</sup> X 12 IN<sup>13/16</sup>

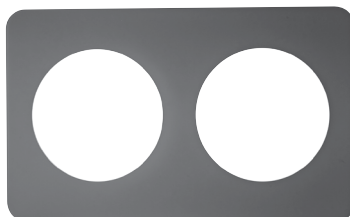

**230756**  
**GN 1/1 - 2 TROUS**  
2 HOLES  
53,5 X 32,5 CM - 20 IN<sup>7/8</sup> X 12 IN<sup>13/16</sup>



**230753**  
**GN 2/3**  
35,4 X 32,5 CM  
13 IN<sup>15/16</sup> X 12 IN<sup>13/16</sup>



**245097 NEW**  
**GN 2/3**  
35,4 X 32,5 CM  
13 IN<sup>15/16</sup> X 12 IN<sup>13/16</sup>



**202628**  
**GN 2/3**  
35,4 X 32,5 CM  
13 IN<sup>15/16</sup> X 12 IN<sup>13/16</sup>



**230757**  
**GN 1/3 - 2 TROUS - BOLS 14 CM**  
2 HOLES - BOWLS 5,5 IN  
17,5 X 32,5 CM - 6 IN<sup>7/8</sup> X 12 IN<sup>13/16</sup>



**COMPATIBLES AVEC BOLS 136529**

AVAILABLE WITH BOWLS 24 CM - 9 IN<sup>7/16</sup>  
CONTENANCE : 2 L  
CAPACITY : 67 OZ<sup>5/8</sup>  
H : 11 CM - 4 IN<sup>1/4</sup>

**136511**  
20 CM - 7 IN<sup>7/8</sup>  
CONTENANCE : 1,30 L  
CAPACITY : 43 OZ<sup>15/16</sup>  
H : 9,5 CM - 3 IN<sup>3/4</sup>



**245098 NEW**  
**GN 1/3**  
17,5 X 32,5 CM  
6 IN<sup>7/8</sup> X 12 IN<sup>13/16</sup>



**245099 NEW**  
**GN 1/3**  
17,5 X 32,5 CM  
6 IN<sup>7/8</sup> X 12 IN<sup>13/16</sup>  
**PLAT CREUX**  
STONEWARE  
DEEP DISH



**202627**  
**GN 1/3**  
17,5 X 32,5 CM  
6 IN<sup>7/8</sup> X 12 IN<sup>13/16</sup>



**202630**  
**GN 1/3**  
17,5 X 32,5 CM  
6 IN<sup>7/8</sup> X 12 IN<sup>13/16</sup>  
**PLAT CREUX**  
PORCELAINE  
DEEP DISH

(2) Garantie lave-vaisselle, Garantie micro-ondes  
Dish washer safe, Microwave safe

**URNES À JUS DE FRUITS\***  
FRUIT JUICE URNS

Urne à jus de fruit dotée d'un tube central en acier pour glace pilée : parfait maintien de la fraîcheur  
Fruit juice urn with central steel tube to hold crushed ice, for perfect freshness



**FINITION MIROIR**  
MIRROR FINISH

**FINITION BROSSÉE**  
BRUSHED FINISH

**URNE À JUS  
DE FRUITS 4L  
ACIER 18-10**

**231303**  
L 20 CM X P 32 CM X H 45 CM  
W 7 IN<sup>7/8</sup> X D 12 IN<sup>5/8</sup> X H 17 IN<sup>11/16</sup>

**231304**  
L 20 CM X P 32 CM X H 45 CM  
W 7 IN<sup>7/8</sup> X D 12 IN<sup>5/8</sup> X H 17 IN<sup>11/16</sup>

JUICE DISPENSER 135 OZ  
STAINLESS STEEL

**CRISTALLIN SOUFLÉ BOUCHE**  
HAND BLOWN CRYSTALLINE



**CARAFE À JUS 202639**  
**DE FRUIT - 1,2 L** Ø 10,5 CM - H 27,5 CM  
JUICE/BEVERAGE Ø 4 IN<sup>1/8</sup> X H 10 IN<sup>13/16</sup>  
CARAFE - 40 OZ<sup>9/16</sup>

**PORCELAINE**  
PORCELAIN



**CARAFE 202636**  
**À LAIT - 1,2 L** Ø 10,5 CM - H 27,5 CM  
MILK JUG Ø 4 IN<sup>1/8</sup> X H 10 IN<sup>13/16</sup>  
- 40 OZ<sup>9/16</sup>

Bouchon verseur, pour une meilleure hygiène  
Hygienic pouring stopper



**BOUCHON DE 202855**  
**CARAFE SILICONE** Ø 6,5 CM - H 4,2 CM  
STOPPER FOR Ø 2 IN<sup>9/16</sup> X H 1 IN<sup>5/8</sup>  
CARAFE SILICONE

\*Certaines pièces sont disponibles en pièces détachées  
Some items are available individually

**DISTRIBUTEURS À CÉRÉALES\***  
CEREAL DISPENSERS

Distributeur à céréales 1 ou 3 tubes avec ailettes souples pour ne pas casser les céréales  
Cereal dispenser 1 or 3 tubs with flexible spout so as not to break the cereals



X3

**DISTRIBUTEUR À CÉRÉALES 231300**

CEREAL DISPENSER L 50 CM X P 20 CM X H 55,5 CM  
W 19 IN<sup>11/16</sup> X D 7 IN<sup>7/8</sup> X H 21 IN<sup>7/8</sup>  
CAPACITÉ : 3 X 3,5 L  
CAPACITY : 3 X 1 GAL



X1

**231299**

L 19 CM X P 20 CM X H 55,5 CM  
W 7 IN<sup>1/2</sup> X D 7 IN<sup>7/8</sup> X H 21 IN<sup>7/8</sup>  
CAPACITÉ : 3,5 L  
CAPACITY : 1 GAL



**RAFRAICHISSEUR 237501**

**DOUBLE PAROI** Ø 13,9 X H 19,8 CM  
CURVED Ø 5 IN<sup>7/8</sup> X H 7 IN<sup>13/16</sup>  
DOUBLE WALL  
WINE COOLER



**BOL 154245**

**PORCELAINE MODULO BLANC**  
PORCELAIN BOWL WHITE MODULO  
14 CM - 5 IN<sup>1/2</sup>

**202626**  
**EMPILABLE**  
STACKABLE



**ETIQUETTE PORCELAINE 202632**  
**AVEC AIMANT** 10 X 5 CM

**+ SUPPORT ACIER** 3 IN<sup>5/16</sup> X 1 IN<sup>15/16</sup>  
PORCELAIN STICK +  
STAINLESS STEEL STAND  
WITH MAGNET

# TRAYS

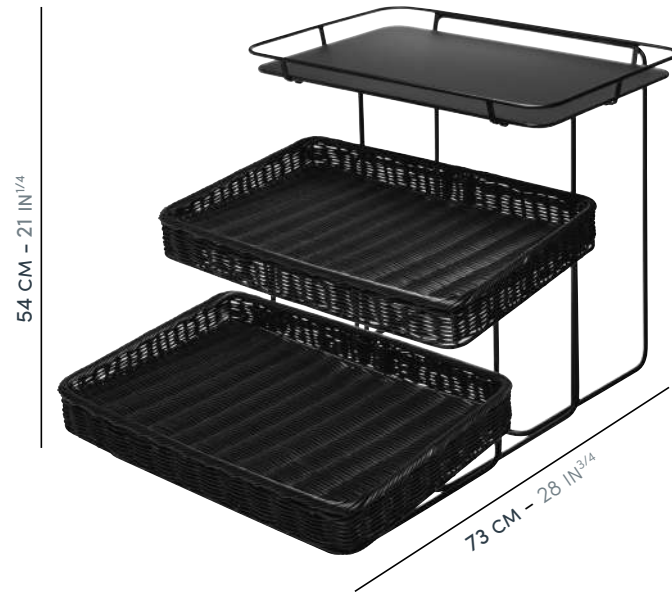

Panière reversible pour une présentation droite ou inclinée  
Reversible basket for a level or titled display

# SUPPORTS À FIL

---



Des supports en acier noir mat de hauteurs différentes pour rythmer les présentations.  
Black mat finish supports of differing heights can be used to create a varied presentation.

**SUPPORTS À FIL RECTANGULAIRES**  
RECTANGULAR TRAYS



1

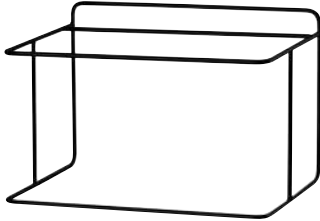

2

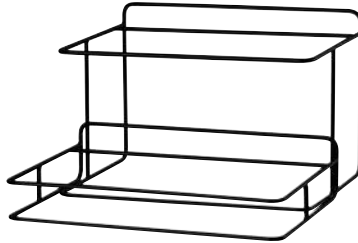

1 + 2



**PANIÈRE 230749**  
**RECTANGULAIRE GN 1/1**  
RECTANGULAR 54 X 34 X H 7 CM  
BREAD BASKET 21 IN<sup>1/4</sup> X 13 IN<sup>3/8</sup> X 2 IN<sup>3/4</sup>

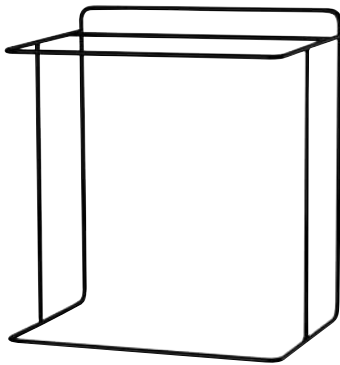

3

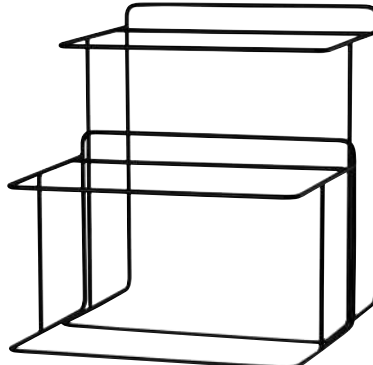

2 + 3

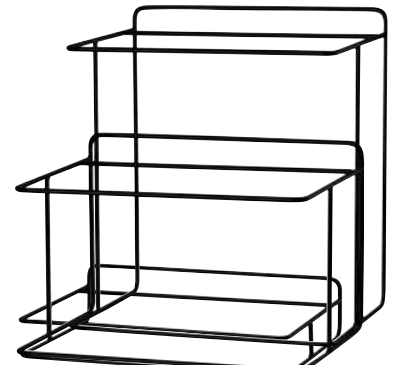

1 + 2 + 3

**SUPPORT 230741**  
**RECTANGULAIRE NIVEAU 1**  
RECTANGULAR TRAY LEVEL 1  
L 44 X P 30,8 X H 10,8 CM  
W 17 IN<sup>5/16</sup> X D 12 IN<sup>1/8</sup> X H 4 IN<sup>1/4</sup>

**230742**  
**NIVEAU 2**  
LEVEL 2  
L 42 X P 30,8 X H 29,8 CM  
W 16 IN<sup>5/16</sup> X D 12 IN<sup>1/8</sup> X H 11 IN<sup>3/4</sup>

**230743**  
**NIVEAU 3**  
LEVEL 3  
L 40 X P 30,8 X H 48,8 CM  
W 15 IN<sup>3/4</sup> X D 12 IN<sup>1/8</sup> X H 19 IN<sup>3/16</sup>

**230741 + 230742**  
**NIVEAU 1 + 2**  
LEVEL 1+2  
L 44 X P 50 X H 29,8 CM  
W 17 IN<sup>5/16</sup> X D 19 IN<sup>11/16</sup> X H 11 IN<sup>3/4</sup>

**230742 + 230743**  
**NIVEAU 2 + 3**  
LEVEL 2+3  
L 42 X P 50 X H 48,8 CM  
W 16 IN<sup>5/16</sup> X D 19 IN<sup>11/16</sup> X H 19 IN<sup>3/16</sup>

**230741 + 230742 + 230743**  
**NIVEAU 1 + 2 + 3**  
LEVEL 1+2+3  
L 44 X P 68,2 X H 48,8 CM  
W 17 IN<sup>5/16</sup> X D 26 IN<sup>7/8</sup> X H 19 IN<sup>3/16</sup>

**SUPPORTS À FIL ROUNDS**  
ROUND TRAYS

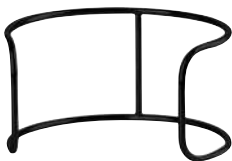

**SUPPORT 230745**  
**ROND BAS - LOW LEVEL**  
ROUND STAND Ø 25 CM X H 13 CM  
Ø 9 IN<sup>13/16</sup> X H 5 IN<sup>1/8</sup>

**230746**  
**HAUT - HIGH LEVEL**  
Ø 25 CM X H 26 CM  
Ø 9 IN<sup>13/16</sup> X H 10 IN<sup>1/4</sup>

**GRÈS ONYX<sup>(1)</sup>**  
ONYX STONEWARE



**SALADIER 245100 NEW**  
**BAS** Ø 25,4 X 7 CM - 2,4 L  
**SALAD BOWL** Ø 10 IN X 2 IN<sup>3/4</sup> - 80 OZ<sup>1/8</sup>



**PANIÈRES 230750**  
BREAD BASKETS **INDIVIDUELLE-INDIVIDUAL**  
Ø 18 CM X 6 CM  
Ø 7 IN<sup>1/16</sup> X 2 IN<sup>3/8</sup>

**230748**  
**RONDE-ROUND**  
Ø 32 CM X H 8 CM  
Ø 12 IN<sup>5/8</sup> X H 3 IN<sup>1/8</sup>

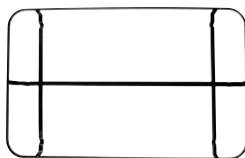

**CADRE ACIER 230744**  
**POUR SUPPORT** L 55,5 X P 35 X H 4,5 CM  
**RECTANGULAIRE**<sup>(1)</sup> W 21 IN<sup>7/8</sup> X D 13 IN<sup>3/4</sup> X H 1 IN<sup>3/4</sup>  
 STEEL FRAME FOR STAND



**PLANCHE À PAIN 202854**  
**BAMBOU AVEC GN 1/1**  
**RÉCUPÉRATEUR** 53 X 32,5 CM  
**DE MIETTES** 20 IN<sup>7/8</sup> X 12 IN<sup>13/16</sup>  
 BAMBOO BREAD BOARD  
 WITH CRUMB TRAY

**MÉLAMINE BOIS**<sup>(2)</sup>  
 WOOD MELAMINE TRAY



**PLATEAUX 234546**  
 TRAYS **GN1/1**  
 53,5 X 32,5 CM  
 20 IN<sup>7/8</sup> X 12 IN<sup>13/16</sup>

**MÉLAMINE PIERRE**<sup>(2)</sup>  
 STONE MELAMINE TRAY



**234547**  
**GN1/1**  
 53,5 X 32,5 CM  
 20 IN<sup>7/8</sup> X 12 IN<sup>13/16</sup>

**ACIER 18/10 NEWPORT**  
**FINITION MIROIR**  
 SERVING TRAY STAINLESS STEEL  
 18/10 MIRROR FINISHED



**238962**  
**GN1/1**  
 53,5 X 32,5 CM  
 20 IN<sup>7/8</sup> X 12 IN<sup>13/16</sup>

**VERRE ÉPAISSEUR 0,6 CM**  
 TEMPERED GLASS THICKNESS IN<sup>4</sup>

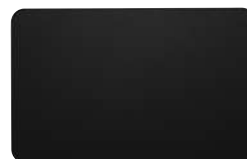

**230752**  
**GN1/1**  
 53,5 X 32,5 CM  
 20 IN<sup>7/8</sup> X 12 IN<sup>13/16</sup>

**MÉLAMINE BOIS**<sup>(2)</sup>  
 WOOD MELAMINE TRAY



**PLATEAUX RONDS 234561**  
 ROUND TRAYS Ø 32 CM  
 12 IN<sup>5/8</sup>

**MÉLAMINE PIERRE**<sup>(2)</sup>  
 STONE MELAMINE TRAY



**234562**  
 Ø 32 CM  
 12 IN<sup>5/8</sup>

**PORCELAINE MODULO**  
 MODULO PORCELAIN  
 PIE/PIZZA PLATE, FLAT



**136524**  
 Ø 32 CM  
 12 IN<sup>5/8</sup>

(1) Compatible lave-vaisselle, Compatible micro-ondes  
 Dish washer safe, Micro-wave safe

(2) Compatible lave-vaisselle, NON compatible micro-ondes  
 Dish washer safe, DONT USE with micro-wave safe



# BOARDS

EPAISSEUR - 2 CM  
THICKNESS - 1/2 IN

**CHÈNE**  
OAK



**PLANCHE RONDE 242942**  
ROUND BOARD 29,4 CM - 11 1/2 IN



**COMPATIBLE AVEC  
LA CLOCHE EVENTO 239771**  
COMPATIBLE WITH  
EVENTO DOME COVER

**NOYER**  
WALNUT



**PLANCHE RONDE 242946**  
ROUND BOARD 29,4 CM - 11 1/2 IN



**PLANCHE BAHIA 242941**  
BAHIA BOARD 35 X 21 CM - 13 3/4 X 8 1/4



**PLANCHE BAHIA 242945**  
BAHIA BOARD 35 X 21 CM - 13 3/4 X 8 1/4



**PLANCHE CARREE 242940**  
SQUARE BOARD 36,7 X 30 CM - 14 1/2 X 11 13/16



**PLANCHE CARREE 242944**  
SQUARE BOARD 36,7 X 30 CM - 14 1/2 X 11 13/16



**PLANCHE ALLONGEE 242939**  
LONG BOARD 50 X 21 CM - 19 11/16 X 8 1/4



**PLANCHE ALLONGEE 242943**  
LONG BOARD 50 X 21 CM - 19 11/16 X 8 1/4



# PLANCHES LES ESSENCES

---



DEGRENE  
1825

# ACCESSORIES



**SALADIER 142722**  
**PORCELAINE** 28 CM - 11 IN  
**MODULO** H : 12 CM - 4 IN<sup>3/4</sup>  
 DEEP SALAD CONTENANCE : 2,5 L  
 BOWL, LARGE CAPACITY : 84 OZ<sup>3/16</sup>



**PRÉSENTOIR 209381**  
**À GÂTEAUX ROND** Ø 25 CM - 9 IN<sup>13/16</sup>  
 ROUND APP/PIZZA/  
 PRESENTATION STAND **209382**  
 Ø 32 CM - 12 IN<sup>5/6</sup>



**CLOCHE 239769**  
**EVENTO VERRE** Ø 16 CM - 6 IN<sup>5/16</sup>  
 EVENTO  
 DOME COVER **239770**  
 Ø 23 CM - 9 IN<sup>1/6</sup>  
**239771**  
 Ø 28 CM - 11 IN



**SUPPORT COUVERTS 202633**  
**DE SERVICE** 21 X 10 X 5 CM  
**PORCELAINE** 8 IN<sup>1/4</sup> X 3 IN<sup>15/16</sup> X 1 IN<sup>15/16</sup>  
 SERVING  
 CUTLERY DISPLAY  
 WHITE PORCELAIN



**ETIQUETTE 202632**  
**PORCELAINE** 10 X 5 CM  
**AVEC AIMANT** 3 IN<sup>15/16</sup> X 1 IN<sup>15/16</sup>  
 + **SUPPORT ACIER**  
 PORCELAIN STICK +  
 STAINLESS STEEL STAND  
 WITH MAGNET

**MÉLAMINE BOIS<sup>(2)</sup>**  
 WOOD MELAMINE TRAY



**(1) PLANCHA 234559**  
**AVEC MANCHE** 17,5 X 45 CM  
 BOARD 6 IN<sup>7/8</sup> X 17 IN<sup>11/16</sup>

**MÉLAMINE PIERRE<sup>(2)</sup>**  
 STONE MELAMINE TRAY



**234560**  
 17,5 X 45 CM  
 6 IN<sup>7/8</sup> X 17 IN<sup>11/16</sup>



**CISEAUX** ✪ 204496  
**À GÂTEAUX** ✪ 101494  
 PASTRY  
 20 CM - 7 IN<sup>7/8</sup>  
 SCISSORS/TONG



**PINCE À SERVIR** ✪ 204499  
 SERVING TONG ✪ 184355  
 29,5 CM - 11 IN<sup>5/8</sup>



**PINCE À PAIN** ✪ 204498  
 BREAD TONG ✪ 101492  
 23 CM - 9 IN<sup>1/16</sup>



**LOUCHE** ✪ 153193  
 SOUP LADLE **ASTRÉE MIROIR**  
 29,7 CM - 11 IN<sup>11/16</sup>

**(1) Planche de présentation uniquement, ne pas faire de découpe**  
 Presentation board, dont cut on it

**(2) Compatible lave-vaisselle, NON compatible micro-ondes**  
 Dish washer safe, DONT USE with micro-wave

# ACCESSOIRES

**PIERRE DE LUNE**  
MOONSTONE  
Porcelaine - Porcelain



**SALADIER 239325**  
LARGE DEEP 28 CM - 11 IN  
PLATE/CUP 4L - 135 OZ<sup>1/4</sup>

**DUNE**  
BEIGE DUNE  
Grès - Stoneware



**235223**  
28 CM - 11 IN  
4L - 135 OZ<sup>1/4</sup>

**BLEU DE ROCHE**  
BLUE STONE  
Grès - Stoneware



**235222**  
28 CM - 11 IN  
4L - 135 OZ<sup>1/4</sup>

**ONYX**  
BLACK ONYX  
Grès - Stoneware



**240499**  
28 CM - 11 IN  
4L - 135 OZ<sup>1/4</sup>

**ARGILE VERTE**  
GREEN CLAY  
Grès - Stoneware



**235224**  
28 CM - 11 IN  
4L - 135 OZ<sup>1/4</sup>



**PLANCHE 242054**  
**RECTANGULAIRE** 35 x 21 CM  
RECTANGULAR 13 IN<sup>3/4</sup> x 8 IN<sup>1/4</sup>  
BOARD



**242056**  
35 x 21 CM  
13 IN<sup>3/4</sup> x 8 IN<sup>1/4</sup>



**242052**  
35 x 21 CM  
13 IN<sup>3/4</sup> x 8 IN<sup>1/4</sup>



**237206**  
25 X 13,5 CM  
9 IN<sup>13/16</sup> X 5 IN<sup>5/16</sup>



**234949**  
25 X 13,5 CM  
9 IN<sup>13/16</sup> X 5 IN<sup>5/16</sup>

**234948**  
25 X 13,5 CM  
9 IN<sup>13/16</sup> X 5 IN<sup>5/16</sup>

**234950**  
25 X 13,5 CM  
9 IN<sup>13/16</sup> X 5 IN<sup>5/16</sup>



**PLANCHE 242055**  
**RONDE** 29 CM - 11 IN<sup>7/16</sup>  
ROUND  
BOARD



**242057**  
29 CM - 11 IN<sup>7/16</sup>



**242053**  
29 CM - 11 IN<sup>7/16</sup>



**PLAT 241835**  
**GRAND MODÈLE** 31,8 x 25 x 7,4 CM  
LARGE DISH 12 IN<sup>1/2</sup> x 9 IN<sup>13/16</sup> x 2 IN<sup>15/16</sup>

**PLAT 241834**  
**MOYEN MODÈLE** 22,8 x 16,2 x 5,4 CM  
MEDIUM DISH 9 IN x 6 IN<sup>3/8</sup> x 2 IN<sup>1/8</sup>

**PLAT 241833**  
**PETIT MODÈLE** 15,5 x 10,7 x 4,4 CM  
SMALL DISH 6 IN<sup>7/8</sup> x 4 IN<sup>3/16</sup> x 1 IN<sup>3/4</sup>



**237595**  
31,8 x 25 x 7,4 CM  
12 IN<sup>1/2</sup> x 9 IN<sup>13/16</sup> x 2 IN<sup>15/16</sup>

**237594**  
22,8 x 16,2 x 5,4 CM  
9 IN x 6 IN<sup>3/8</sup> x 2 IN<sup>1/8</sup>

**237593**  
15,5 x 10,7 x 4,4 CM  
6 IN<sup>7/8</sup> x 4 IN<sup>3/16</sup> x 1 IN<sup>3/4</sup>



56,5 CM - 22 IN<sup>1/4</sup>

56,5 CM - 22 IN<sup>1/4</sup>

56,5 CM - 22 IN<sup>1/4</sup>

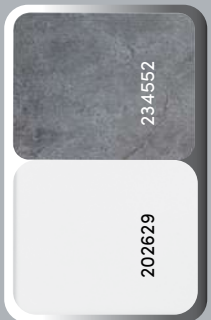
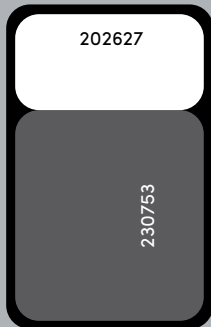

36 CM - 14 IN<sup>3/16</sup>

35,5 CM - 14 IN

35,5 CM - 14 IN

230746 + 230748

41 CM - 16 IN<sup>1/8</sup>

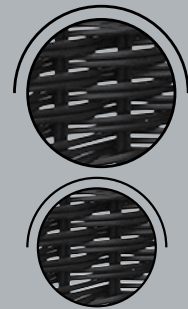
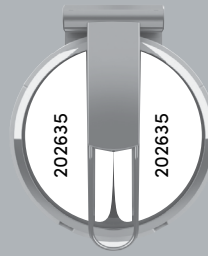

68,2 CM - 26 IN<sup>7/8</sup>



230744 +

# PLAN



44 CM - 14 IN



+ 230743

+ 230742

202854 + 230741



242055

29 CM - 11 IN<sup>7/16</sup>



239325

Ø 28 CM  
Ø 11 IN



240499

234562  
Ø 32 CM - 12 IN<sup>5/8</sup>

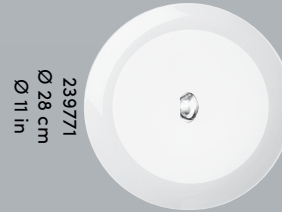

239771  
Ø 28 cm  
Ø 11 in

Ø 32 cm  
Ø 12 IN<sup>5/8</sup>

209382

35.5 CM - 14 IN

20 CM - 7 IN<sup>7/8</sup>

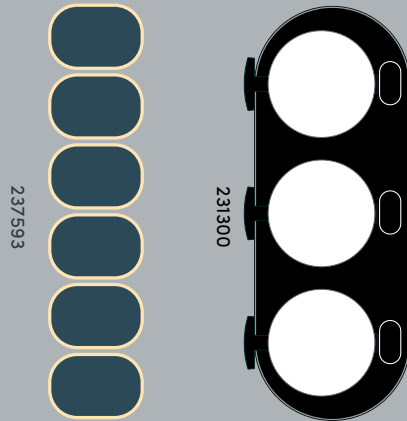

231300

237593

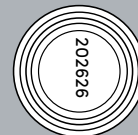

202626

32 CM - 12 IN<sup>5/8</sup>

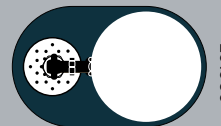

231303

20 CM  
7 IN<sup>7/8</sup>

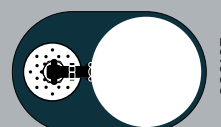

231303

20 CM  
7 IN<sup>7/8</sup>

50 CM - 19 IN<sup>11/16</sup>

## CHAFING DISH

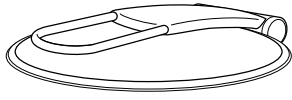

**COUVERCLE AVEC GOUTTIÈRE** **203470**  
**ACIER ET VERRE TREMPÉ** Ø 33 CM - Ø 13 IN  
LID WITH STAINLESS STEEL  
GUTTER,  
TEMPERED GLASS

**JOINT POUR CHAFING DISH** **230050**  
SEAL FOR CHAFING DISH

**KIT REPARATION CHARNIERES** **247023**  
**P/CHAFING DISH**  
CHAFING DISH  
HINGE REPAIR KIT

## MODULE FROID REFRIGERATED UNIT



**BAC PLASTIQUE** **202866**  
PLASTIC TRAY 56 X 35,5 X 8 CM  
22 IN<sup>1/16</sup> X 14 IN X 3 IN<sup>1/8</sup>

**235357**  
29,5 X 35,6 CM  
11 IN<sup>5/8</sup> X 14 IN

# PIÈCES DÉTACHÉES

## URNE À JUS DE FRUITS FRUIT JUICE URN

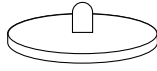

**COUVERCLE URNE** 202881  
**ACIER 18-10** **FINITION MIROIR**  
LID FOR STAINLESS MIRROR FINISH  
DISPENSER 18-10 Ø 17,9 CM  
7 IN<sup>1/16</sup>

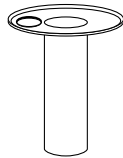

**TUBE ACIER POUR** 202884  
**GLACE** Ø 9 CM - 3 IN<sup>9/16</sup>  
ICE TUBE  
STAINLESS STEEL

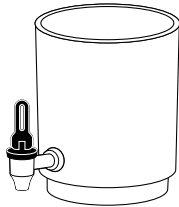

**FÛT CYLINDRIQUE** 202883  
**URNE** 5 L - 169 OZ<sup>1/16</sup>  
CONTAINER FOR Ø 17,7 CM X H 25,5 CM  
DISPENSER Ø 6 IN<sup>15/16</sup> X H 10 IN<sup>1/16</sup>

**ROBINET ACIER** 214724  
**ABS NOIR**  
STAINLESS STEEL  
FAUCET BLACK

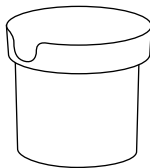

**BASE ACIER** 202890  
**18-10 URNE** **FINITION MIROIR**  
STAINLESS STEEL MIRROR FINISH  
STAND FOR Ø 17,6 CM - H 19 CM  
DISPENSER 18-10 6 IN<sup>15/16</sup> X 7 IN<sup>1/2</sup>

**202889**  
**FINITION BROSSÉE**  
BRUSHED FINISH  
Ø 17,6 CM - H 19 CM  
6 IN<sup>15/16</sup> X 7 IN<sup>1/2</sup>



**GRILLE ACIER** 045963  
**POUR GOUTTES - 18/10** Ø 9 CM  
STAINLESS STEEL GRID Ø 3 IN<sup>9/16</sup>  
DROP COLLECTOR



**SOCLE NOIR ACRYLIQUE URNE** 230758  
STAND FOR BLACK DISPENSER 20 X 32 CM  
7 IN<sup>7/8</sup> X 12 IN<sup>5/8</sup>  
ÉPAISSEUR : 2 CM  
THICKNESS: 13/16 IN

## DISTRIBUTEUR À CÉRÉALES CEREAL DISPENSER



**COUVERCLE** 213078  
**DISTRIBUTEUR CEREALES** Ø 12,5 CM  
**ACIER FINITION MIROIR - 18/10** Ø 4 IN<sup>15/16</sup>  
LID FOR CEREAL DISPENSER,  
STAINLESS STEEL,  
MIRROR FINISH

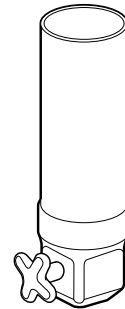

**FUT CYLINDRIQUE** 213076  
**AVEC AILETTE ET POIGNEE** P 16,1 X H 42 CM  
**DISTRIBUTEUR CEREALES** D 6 IN<sup>5/16</sup> X H 16 IN<sup>9/16</sup>  
BARREL + HANDLE + ROLLING TAP  
FOR CEREAL DISPENSER

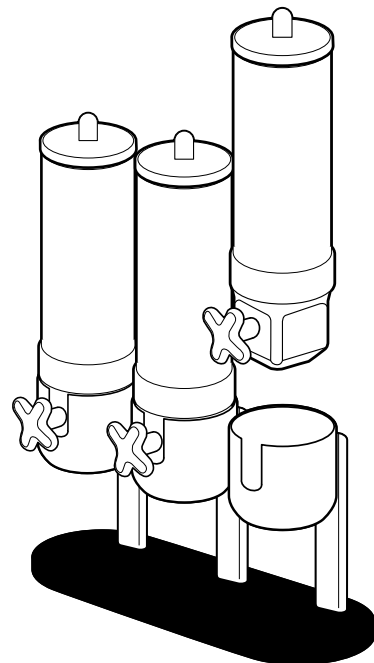

X3

X1

**BASE + TUBE + SOCLE** 231302  
**DISTRIBUTEUR À CEREALES** L 50 X H 27,5 CM  
STAINLESS STEEL STAND + TUB L 19 IN<sup>11/16</sup> X H 29 IN<sup>3/4</sup>  
+ ACRYLIC STAND FOR CEREAL DISPENSER

**231301**  
L 19 X H 27,5 CM  
L 7 IN<sup>1/2</sup> X H 29 IN<sup>3/4</sup>

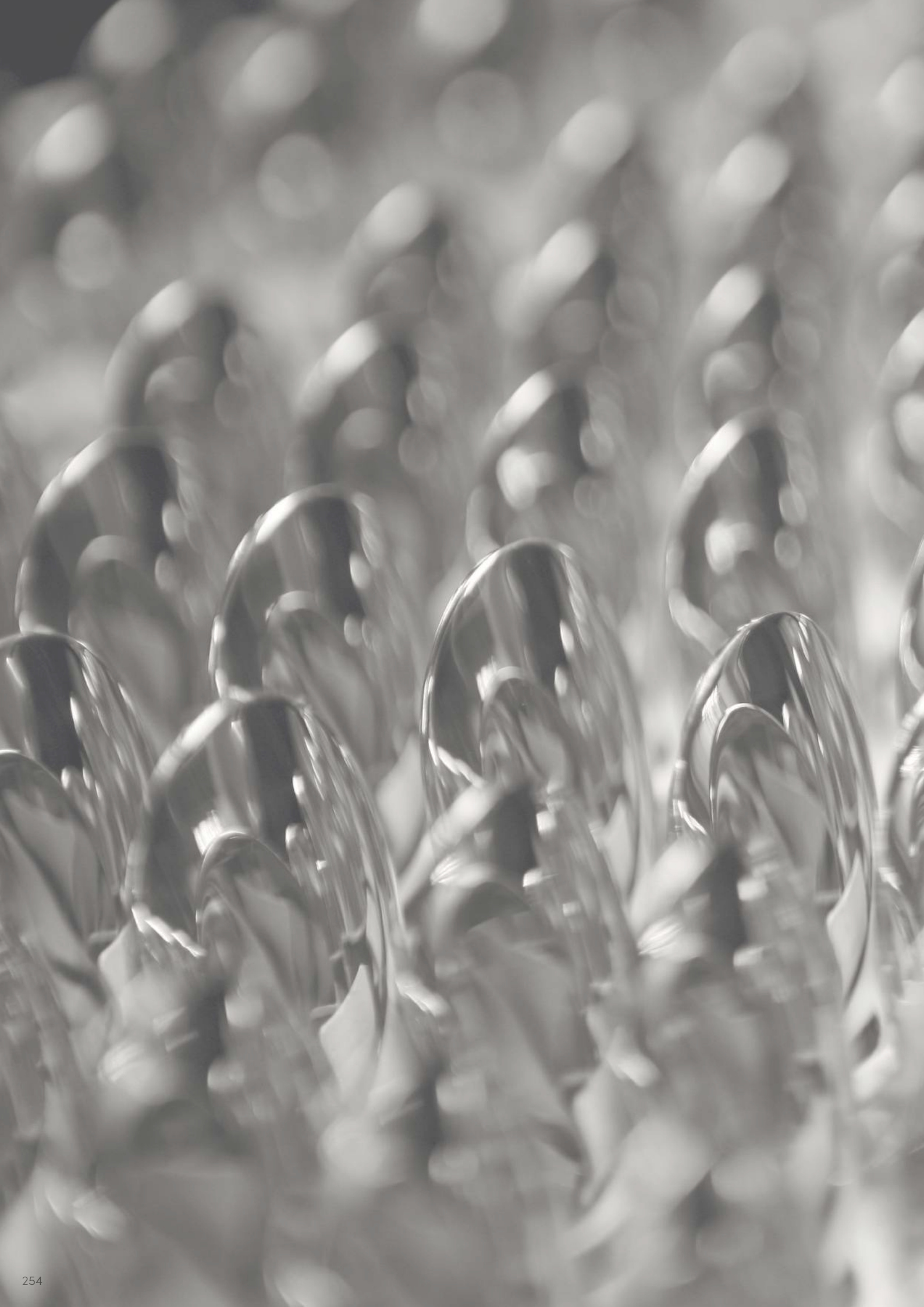



# LES BASIQUES

## Basics

Pensés initialement pour répondre aux besoins des collectivités, «LES BASIQUES» revisitent des gammes de couverts et platerie Made In France ainsi que de vaisselle Made in Europe. Chaque pièce évoque discrètement ce mélange entre héritage et exigences contemporaines : des formes simples, des détails subtils, et un usage fonctionnel. Le tout avec le marquage DEGRENNE, véritable gage de qualité.

En mariant judicieusement des formes issues de nos archives à une approche moderne, ces collections s'inscrivent dans une démarche éco-responsable et deviennent un choix idéal pour tout établissement à la recherche d'une touche de rétro.

Originally designed to meet the needs of communities, BASICS reimagines its ranges of Made In France cutlery and tableware, as well as those of Made in Europe dinnerware. Each piece subtly reflects the blend of heritage and contemporary requirements: simple shapes, subtle details, and functional use. All of this comes with the DEGRENNE branding, a true mark of quality.

By skillfully combining shapes from our archives with a modern approach, these collections embraces an eco-responsible approach and becomes an ideal choice for establishments seeking a touch of retro.



**169511**  
**FOURCHETTE DE TABLE**  
TABLE FORK  
19,9 CM - 7 IN<sup>13/16</sup>



**169513**  
**COUTEAU À STEAK**  
**MONOBLOC LAME SCIE**  
STEAK KNIFE SOLID HANDLE SERRATED  
22,3 CM - 8 IN<sup>3/4</sup>



**169510**  
**CUILLÈRE DE TABLE**  
TABLE/PASTA SPOON  
20,1 CM - 7 IN<sup>15/16</sup>



**184372**  
**FOURCHETTE À DESSERT/POISSON**  
DESSERT/SALAD/FISH FORK  
17,9 CM - 7 IN<sup>1/16</sup>



**184374**  
**CUILLÈRE À DESSERT**  
DESSERT/SOUP SPOON, OVAL  
18 CM - 7 IN<sup>1/16</sup>



**184371**  
**COUTEAU À DESSERT**  
**MONOBLOC LAME UNIE**  
DESSERT KNIFE SOLID HANDLE  
19,8 CM - 7 IN<sup>13/16</sup>



**169512**  
**CUILLÈRE À CAFÉ**  
COFFEE/TEA SPOON  
13,6 CM - 5 IN<sup>3/8</sup>

## Bar

**136123**  
**LOT DE 12 CUILLÈRES MOKA**  
BATCH OF 12 DEMI TASSE SPOONS  
10,8 CM - 4 IN<sup>1/4</sup>

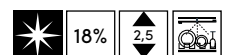

AMAZONE





**193762**  
**FOURCHETTE DE TABLE**  
 TABLE FORK  
 20 CM - 7 IN<sup>7/8</sup>



**193764**  
**COUTEAU DE TABLE**  
**MONOBLOC LAME SCIE**  
 TABLE KNIFE SOLID HANDLE SERRATED  
 23,2 CM - 9 IN<sup>5/8</sup>



**193761**  
**CUILLÈRE DE TABLE**  
 TABLE/PASTA SPOON  
 20,2 CM - 7 IN<sup>15/16</sup>



**195773**  
**FOURCHETTE À DESSERT**  
 DESSERT/SALAD FORK  
 17,9 CM - 7 IN



**195772**  
**CUILLÈRE À DESSERT**  
 DESSERT/SOUP SPOON, OVAL  
 17,8 CM - 7 IN



**195774**  
**COUTEAU À DESSERT**  
**MONOBLOC LAME UNIE**  
 DESSERT KNIFE SOLID HANDLE  
 20,2 CM - 7 IN<sup>15/16</sup>



**193763**  
**CUILLÈRE À CAFÉ**  
 COFFEE/TEA SPOON  
 13,6 CM - 5 IN<sup>3/8</sup>



**198323**  
**CUILLÈRE MOKA**  
 DEMI TASSE SPOON  
 11 CM - 4 IN<sup>5/16</sup>

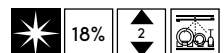

CASSIOPEE



BLANC  
WHITE



**ASSIETTE 216531**  
**PLATE** 12 CM - 4 IN<sup>3/4</sup>  
**RONDE**  
ROUND  
PLATE



**ASSIETTE 216530**  
**À SALADE** 20 CM - 7 IN<sup>7/8</sup>  
**RONDE**  
ROUND  
SALAD  
PLATE



**ASSIETTE 216532**  
**OBLONGUE** 19 X 32 CM - 7 IN<sup>1/2</sup> X 12 IN<sup>5/8</sup>  
**PLATE** **216533**  
12 X 20 CM - 4 IN<sup>3/4</sup> X 7 IN<sup>7/8</sup>



**ASSIETTE 216536**  
**À CREME BRULEE** 13,5 CM - 5 IN<sup>5/16</sup>  
CREME BRULEE  
ROUND PLATE



**COUPELLE 216535**  
**RONDE** 14 CM - 5 IN<sup>1/2</sup>  
ROUND  
**DEEP** **216534**  
**PLATE** 12 CM - 4 IN<sup>3/4</sup>  
20 CL - 7 OZ<sup>7/8</sup>

GRIS  
GREY



**PLAT À GRATIN 198935**  
**RONDE** 14 CM - 5 IN<sup>1/2</sup>  
ROUND  
CASSEROLE  
PLATE



**GOBELET 198936**  
**RONDE** 9 CM - 3 IN<sup>9/16</sup>  
ROUND CUP



# ESSENTIELLE

---

MADE IN EUROPE 





**ASSIETTE 194112**  
**PLATE** 26 CM - 10 IN<sup>1/4</sup>  
 DINNER PLATE



**ASSIETTE 194115**  
**DESSERT** 20 CM - 7 IN<sup>7/8</sup>  
 ROUND  
 DESSERT  
 PLATE



**ASSIETTE 194113**  
**CREUSE** 22 CM - 8 IN<sup>11/16</sup>  
 ROUND  
 SOUP PLATE **194114**  
 19 CM - 7 IN<sup>1/2</sup>



**ASSIETTE 194116**  
**À PAIN** 15 CM - 5 IN<sup>7/8</sup>  
 ROUND  
 BREAD & BUTTER  
 PLATE



**PLAT ROND PLAT 194110**  
 ROUND DISH 30 CM - 11 IN<sup>13/16</sup>



**PLAT OVALE 194122**  
 OVAL DISH 36 CM - 14 IN<sup>3/16</sup>  
**194123**  
 28 CM - 11 IN



**PLAT 194121**  
**À CAKE** 40x13 CM - 15<sup>3/4</sup>x5<sup>1/8</sup>  
 RECTANGULAR  
 CAKE DISH



**BOL 194120**  
 BOWL 13 CM - 5 IN<sup>1/8</sup>



**SAUCIERE 194139**  
 SAUCE JUG 20 CL - 6 OZ<sup>3/4</sup>



**CREMIER 194137**  
 CREAM JUG 10 CL - 3 OZ<sup>3/8</sup>



**MUG 247356 NEW**  
 MUG 30 CL - 11 OZ<sup>13/16</sup>



**TASSE À ESPRESSO 194125**  
 ESPRESSO CUP 9 CL - 3 OZ<sup>1/16</sup>



**TASSE À CAFÉ 194126**  
 DEMITASSE CUP 18 CL - 6 OZ<sup>1/16</sup>



**TASSE À THÉ 194127**  
 COFFEE/TEA CUP 26 CL - 8 OZ<sup>13/16</sup>

**SOUCOUE À ESPRESSO 194129**  
 ESPRESSO SAUCER 13 CM - 5 IN<sup>1/8</sup>

**SOUCOUE À CAFÉ 194130**  
 DEMITASSE SAUCER 14 CM - 5 IN<sup>1/2</sup>

**SOUCOUE À THÉ 194131**  
 COFFEE/TEA SAUCER 16 CM - 6 IN<sup>7/16</sup>





GLORIA

MADE IN EUROPE





**ASSIETTE 109343**  
**PLATE** 26,5 CM - 10 IN<sup>3/7</sup>  
 ROUND  
 DINNER PLATE **109338**  
 24 CM - 9 IN<sup>4/9</sup>  

---

**109340**  
 19 CM - 7 IN<sup>1/2</sup>



**ASSIETTE 109339**  
**CREUSE** 22 CM - 8 IN<sup>2/3</sup>  
 ROUND  
 SOUP PLATE



**ASSIETTE 109344**  
**À PAIN** 16 CM - 6 IN<sup>2/7</sup>  
 ROUND  
 BREAD & BUTTER  
 PLATE



**PLAT OVALE 247357** **NEW**  
 OVAL DISH 38 CM - 14 IN<sup>5/16</sup>



**247358** **NEW**  
 32 CM - 12 IN<sup>5/8</sup>



**247359** **NEW**  
 25 CM - 8 IN<sup>7/16</sup>



**TASSE À MOKA 109341**  
 MOKA CUP 10 CL - 3 OZ<sup>3/8</sup>  

---

**SOUCOUPE À MOKA 109342**  
 MOKA SAUCER 13 CM - 5 IN<sup>1/8</sup>



**TASSE À THÉ 054301**  
 COFFEE/TEA CUP 16 CL - 5 OZ<sup>7/16</sup>  

---

**SOUCOUPE À THÉ 054302**  
 COFFEE/TEA SAUCER 15 CM - 5 IN<sup>7/8</sup>



**TASSE À DÉJEUNER 054303**  
 BREAKFAST CUP 28 CL - 9 OZ<sup>7/16</sup>  

---

**SOUCOUPE À DÉJEUNER 054308**  
 BREAKFAST SAUCER 16 CM - 6 IN<sup>2/7</sup>



# UNISET

---

MADE IN EUROPE 



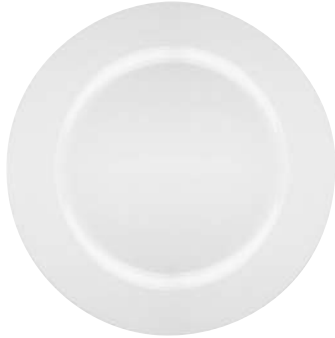

**ASSIETTE 223287**  
**PLATE** 30 CM - 11 IN<sup>13/16</sup>  
 ROUND  
**223286**  
 DINNER PLATE 26,5 CM - 10 IN<sup>7/16</sup>  

---

**223285**  
 20 CM - 7 IN<sup>7/8</sup>



**ASSIETTE 223288**  
**CREUSE** 19 CM - 7 IN<sup>1/2</sup>  
 ROUND  
 SOUP PLATE



**ASSIETTE 223294**  
**À PIZZA** 30 CM - 11 IN<sup>13/16</sup>  
 PIZZA PLATE



**ASSIETTE 223363**  
**À PAIN** 15 CM - 5 IN<sup>7/8</sup>  
 ROUND  
 BREAD & BUTTER  
 PLATE



**MUG 223293**  
 MUG 30 CL - 10 OZ<sup>1/8</sup>



**TASSE À CAFÉ 223289**  
 DEMITASSE CUP 11 CL - 3 OZ<sup>3/4</sup>  

---

**SOUCOUBE À CAFÉ 223290**  
 DEMITASSE SAUCER 12 CM - 4 IN<sup>3/4</sup>



**TASSE À THÉ 223291**  
 COFFEE/TEA CUP 20 CL - 6 OZ<sup>3/4</sup>  

---

**SOUCOUBE À THÉ 223292**  
 COFFEE/TEA SAUCER 15 CM - 5 IN<sup>7/8</sup>



VITAL

MADE IN EUROPE



PLATEAUX  
TRAYS



**PLATEAU COMPARTIMENTÉ 240688**  
LUNCH TRAY 39,5 X 29,5 CM - 15 IN<sup>9/16</sup> X 11 IN<sup>5/8</sup>



**PLATEAU COMPARTIMENTÉ 242663**  
**MATERNELLE** 33,5 X 24,6 CM - 13 IN<sup>3/16</sup> X 9 IN<sup>11/16</sup>  
LUNCH TRAY FOR NURSERY SCHOOL

POTS À VERSER EMPILABLES  
STACKABLE WATER JUGS



**POT À VERSER 003968**  
**EMPILABLE** 2 L - 12 X 17 CM - 67 OZ<sup>5/8</sup> - 4 IN<sup>3/4</sup> X 6 IN<sup>11/16</sup>  
STACKABLE  
WATER JUG

**003967**  
1,5 L - 10,5 X 16 CM - 50 OZ<sup>3/4</sup> - 4 IN<sup>1/8</sup> X 6 IN<sup>5/16</sup>

**003966**  
1 L - 9,5 X 13,5 CM - 33 OZ<sup>13/16</sup> - 3 IN<sup>3/4</sup> X 5 IN<sup>5/16</sup>



POTS À VERSER UNI LOURD  
WATER JUGS



**POT À VERSER 004042**  
WATER JUG 2 L - 12,5 X 19 CM - 67 OZ<sup>5/8</sup> - 4 IN<sup>15/16</sup> X 7 IN<sup>1/2</sup>

**004041**  
1,5 L - 11 X 17,5 CM - 50 OZ<sup>3/4</sup> - 4 IN<sup>5/16</sup> X 6 IN<sup>7/8</sup>

**004040**  
1 L - 9,5 X 15 CM - 33 OZ<sup>13/16</sup> - 3 IN<sup>3/4</sup> X 5 IN<sup>7/8</sup>

**004039**  
0,5 L - 7 X 10 CM - 16 OZ<sup>15/16</sup> - 2 IN<sup>3/4</sup> X 5 IN<sup>15/16</sup>

VISUELS NON CONTRACTUELS  
NON CONTRACTUAL VISUALS



UNI

MADE IN FRANCE



**PLATS À GRATIN**  
RECTANGULAR GRATIN DISHES



**PLAT 003940**  
**À GRATIN** 45 X 31,5 CM - 17 IN<sup>11/16</sup> X 12 IN<sup>3/8</sup>  
**RECTANGULAIRE**  
RECTANGULAR **003941**  
GRATIN DISH 37 X 25 CM - 14 IN<sup>9/16</sup> X 9 IN<sup>13/16</sup>

**PLATS À ESCARGOTS**  
SNAIL DISHES



**PLAT À ESCARGOTS 003935**  
**12 PLACES** 20 CM - 9 IN<sup>11/16</sup>  
SNAIL DISH 12 HOLES  
**6 PLACES 003934**  
SNAIL DISH 6 HOLES 14,5 CM - 6 IN<sup>1/2</sup>



**PLATS À GRATIN OVALES**  
OVAL GRATIN DISHES



**PLAT 003939**  
**À GRATIN** 38 X 28 CM - 14 IN<sup>5/16</sup> X 11 IN  
**OVALE**  
OVALGRATIN DISH **003937**  
24 X 15 CM - 9 IN<sup>7/16</sup> X 5 IN<sup>7/8</sup>

**CORBEILLES À PAIN**  
BREAD BASKETS



**CORBEILLE À PAIN 003919**  
**CANNELÉE** 31 X 21 CM - 12 IN<sup>3/16</sup> X 8 IN<sup>1/4</sup>  
FLUTED  
BREAD BASKET **003918**  
26 X 18 CM - 10 IN<sup>1/4</sup> X 7 IN<sup>1/16</sup>



**SOUPIÈRES**  
SOUP TUREEN



**SOUPIÈRE 003971**  
SOUP TUREEN 24 X 9,5 CM - 9 IN<sup>7/16</sup> X 3 IN<sup>3/4</sup>  
270 CL - 91 OZ<sup>5/16</sup>  
**003970**  
22 X 9,5 CM - 8 IN<sup>11/16</sup> X 3 IN<sup>3/4</sup>  
220 CL - 74 OZ<sup>3/8</sup>  
**003969**  
20 X 8,5 CM - 7 IN<sup>7/8</sup> X 3 IN<sup>3/8</sup>  
170 CL - 57 OZ<sup>1/2</sup>

18-10

18%

18%

**RAMEQUIN**  
RAMEKIN



**RAMEQUIN 003975**  
RAMEKIN 8 CM - 3 IN<sup>1/8</sup>  
19 CL - 6 OZ<sup>7/16</sup>

18-10





**PLATEAUX RECTANGULAIRES**  
RECTANGULAR SERVING TRAYS



**PLATEAU 003929**  
**RECTANGULAIRE AVEC ANSES**  
RECTANGULAR SERVING TRAY WITH HANDLES  
45 X 31,5 CM - 17 IN<sup>11/16</sup> X 12 IN<sup>3/8</sup>



**PLATEAU 003930**  
**RECTANGULAIRE SANS ANSES**  
RECTANGULAR SERVING TRAY WITHOUT HANDLES  
45 X 31,5 CM - 17 IN<sup>11/16</sup> X 12 IN<sup>3/8</sup>

**PLATEAU ROND**  
ROUND SERVING TRAY



**PLATEAU 044811**  
**LIMONADIER**  
ROUND SERVING TRAY  
40 CM - 15 IN<sup>3/4</sup>



**PLATS**  
TRAYS



**PLAT 003947**  
**OVALE**  
OVALE DISH  
46 X 31 CM - 18 IN<sup>1/8</sup> X 12 IN<sup>3/16</sup>

**003945**  
39 X 25 CM - 15 IN<sup>3/8</sup> X 9 IN<sup>13/16</sup>

**003944**  
34 X 23 CM - 13 IN<sup>3/8</sup> X 9 IN<sup>1/16</sup>



**PLAT 003948**  
**À POISSON**  
FISH DISH  
60 X 27 CM - 23 IN<sup>5/8</sup> X 10 IN<sup>5/8</sup>



**PLAT 003951**  
**ROND PLAT**  
ROUND FLAT DISH  
33 CM - 13 IN



**SEAUX**  
BUCKETS



**SEAU À GLACE 004047**  
**AVEC ANSE**  
ICE BUCKET WITH HANDLE  
0,5 L - 10 CM  
16 OZ<sup>15/16</sup> - 3 IN<sup>15/16</sup>



**SEAU À GLACE 160899**  
**SANS ANSE**  
ICE BUCKET WITHOUT HANDLE  
1 L - 13 CM  
33 OZ<sup>13/16</sup> - 5 IN<sup>1/8</sup>



**SEAU À CHAMPAGNE 154148**  
**SANS ANSE**  
CHAMPAGNE BUCKET WITHOUT HANDLE  
300 CL - 19 CM  
101 OZ<sup>7/16</sup> - 7 IN<sup>1/2</sup>





**ARGENTURE CLASSE 1 - 33 MICRONS**  
(POUR LES ARTICLES À USAGE FRÉQUENT)  
CLASS 1 SILVER PLATED - 33 MICRONS



**ARGENTURE QUALITÉ HÔTELIÈRE-  
10 MICRONS**  
SILVER PLATED HOTEL QUALITY- 10 MICRONS



**FINITION MIROIR**  
MIRROR FINISH



**FINITION SATINÉE**  
SATIN FINISH



**FINITION CONTRASTE**  
CONTRAST FINISH



**FINITION VINTAGE**  
VINTAGE FINISH



**FORGÉ**  
FORGED

18%

18-10

**ACIER INOXYDABLE**  
STAINLESS STEEL



**EPAISSEUR FOURCHETTE DE TABLE**  
THICKNESS TABLE FORK



**REVÊTEMENT PVD**  
PVD COATING



**PORCELAIN**  
PORCELAIN



**AIMANTÉ**  
WITH MAGNET



**GRÈS**  
STONEWARE



**EMPILABILITÉ**  
STACKABLE



**RÉSISTE AUX CHOCS**  
SHOCK RESISTANT



**RÉSISTE AUX TACHES**  
STAIN RESISTANT



**VERRE**  
GLASS



**SHQ/ SODOCALCIQUE**  
**HAUTE QUALITÉ**  
HIGH QUALITY SODA - LIME



**CRISTALLIN HAUTE QUALITÉ**  
HQ LOW LEAD CRYSTAL



**VERRE SOUFFLÉ BOUCHE TEINTÉ**  
**DANS LA MASSE**  
HAND-BLOWN INTEGRALLY DYED GLASS



**1000 CYCLES GARANTIS MINIMUM**  
1000 WASH CYCLES GUARANTEED



**CRISTALLIN**  
CRYSTALLINE



**SOUFFLÉ MÉCANIQUE**  
MACHINE BLOWN



**FINESSE DU BUVANT**  
THICKNESS OF THE RIM



**LÉGÈRETÉ**  
LIGHTNESS



**GARANTIE MICRO-ONDES**  
MICROWAVE SAFE



**GARANTIE LAVE-VAISSELLE**  
DISHWASHER SAFE



**GARANTIE CONGÉLATEUR**  
FREEZER SAFE



**GARANTIE FOUR**  
OVEN SAFE



**JUSQU'À ÉPUISEMENT**  
**DES STOCKS**  
UNTIL STOCK LAST



**FABRIQUÉ EN FRANCE**  
MADE IN FRANCE



**FABRIQUÉ EN EUROPE**  
MADE IN EUROPE

**FRANCE USA**

**SIÈGE SOCIAL/HEAD OFFICE**  
**SERVICE CLIENTS/CUSTOMER SERVICES**

rue Guy Degrenne - BP 50056  
14502 Vire cedex  
TEL : +33 02 31 66 44 15

OTHER COUNTRIES  
TEL : +33 02 31 66 44 15

infohotel@degrenne.fr

**FILIALE USA/US SUBSIDIARY**

DNA/DEGRENNÉ NORTH AMERICA INC.  
301 OXFORD VALLEY ROAD, SUITE 1903-B,  
YARDLEY, PA 19067

TEL : +1 732 565 0820  
FAX : +1 732 565 0828

csr.v.dna@degrenneparis.com  
www.degrennenorthamerica.com

**SHOWROOM (BY APPOINTMENT)**  
41 Madison Avenue, 15th Floor  
NEW YORK, NY 10010

[www.pro.degrenne.fr](http://www.pro.degrenne.fr)





**FRANCE**

infohotel@degrenne.fr  
Tel : +33 02 31 66 44 15

**OTHER COUNTRIES/OTROS PAISES**

infohotel@degrenne.fr  
Tel : +33 02 31 66 44 15

**FILIALE USA/US SUBSIDIARY**

csrv.dna@degrennenorthamerica.com  
Tel : +1 732 565 0820

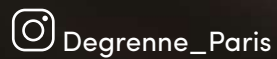

[www.pro.degrenne.fr](http://www.pro.degrenne.fr)